



TNC7 basic

Compact Contouring Control for Milling, Drilling and Boring Machines

www.heidenhain.com/cnc-controls

Contents



Where can it be used?	Intuitive, task-focused and customizable TNC contouring control for milling and milling-turning machines	4
What does it look like?	Intuitive and user-friendly State-of-the-art multitouch operation Highly practical user interface	6
What can it do?	Programming, editing and testing A full range of possibilities with the TNC7 basic	10
	Minimize setup times The TNC7 basic makes setup easy	11
	Automated machining The TNC7 basic measures, manages and communicates automatically Global program settings (option) Pallet management and serial machining	14
	Intelligent machining Dynamic collision monitoring (DCM, option) Dynamic collision monitoring version 2 (DCM v2, option)	16
	Fast and reliable machining at high contour fidelity Dynamic Precision Optimal tool guidance by the TNC7 basic Machining and measuring 3D contours	19
Inspecting and optimizing machine accuracy	Easy calibration of rotary axes with KinematicsOpt (option) Monitoring functions	25
	How is it programmed?	Programming on the shop floor Straightforward function keys for complex contours Graphical programming Practical cycles for recurring operations Practical turning cycles (option) Practical functions for grinding and dressing (option) Reusing programmed contour elements Graphical support in any scenario Rapid availability of all information
Intelligent machining	Dynamic Efficiency Active chatter control (ACC, option) Adaptive feed control (AFC, option) Machine any contour slot with trochoidal milling Optimized roughing processes with OCM (option)	34
	Open to outside information The TNC7 basic understands CAD files Fully digital job management with Connected Machining	39
	What accessories are there?	Workpiece measurement Setup, preset setting and measuring with touch trigger probes
	Tool measurement Measuring length, radius and wear inside the machine	45
	Efficient running-in of NC programs OC 310 override controller	46
	Positioning with an electronic handwheel Fine motion control of axes	47

This brochure describes the functions and specifications of the TNC7 basic with NC software 81762x-18.

Intuitive, task-focused and customizable TNC contouring control for milling machines

For more than 45 years, TNC controls from HEIDENHAIN have proven themselves every day on milling machines, machining centers, and drilling machines. Over this period, they have been continually further developed, with the next level of control technology assisting the user from the initial idea to the finished workpiece:

- From one-off jobs to serial production
- From simple slots to complex contours
- From machine setup to program execution

Task-focused support

In fact, the entire user guidance system is designed around this. You intuitively operate highly complex applications directly on the touchscreen. Many integrated solutions for standard tasks simplify your daily work. Specially developed touch probe cycles guide you through the probing process step by step.

Intelligent solutions

The TNC7 basic makes machining even easier, for everything from programming to program validation and from machine setup to actual machining. The TNC7 basic provides you with task-focused support and thoughtfully designed solutions at every stage along the way, from initial design to the finished workpiece. For example, with graphical programming you draw the workpiece directly on the touchscreen. The TNC7 basic then converts your drawing into Klartext without any delays.

Enjoy a customizable user interface

The TNC7 basic can be customized: you store favorites and decide for yourself where the status information is shown on the dashboard or in the workspaces. You can choose this for your entire shop, for separate teams, or even for each individual user. That way you always see exactly what is needed at the moment, making the machine much easier to operate every step of the way.

Compact and clearly structured

The TNC7 basic is a compact but versatile contouring control for up to five controlled axes and a controlled spindle. Thanks to its user-friendly operation and scope of features, it is especially well suited for use on universal milling machines for the following applications:

- Series and single-part production
- Tool making
- Machine building
- Research and development
- Prototypes and pilot plants
- Repair departments
- Training and education facilities

CAD Viewer as standard

Display your CAD data in the .step or .iges format directly on the TNC7 basic. The standard integrated CAD Viewer can open many common 3D formats and display them on the TNC7 basic screen.

Advanced Dynamic Prediction (ADP)

The TNC7 basic offers its ADP function for demanding milling operations. This optimizes the motion control for all feed axes. With the TNC7 basic, you achieve even higher surface quality and contour fidelity.

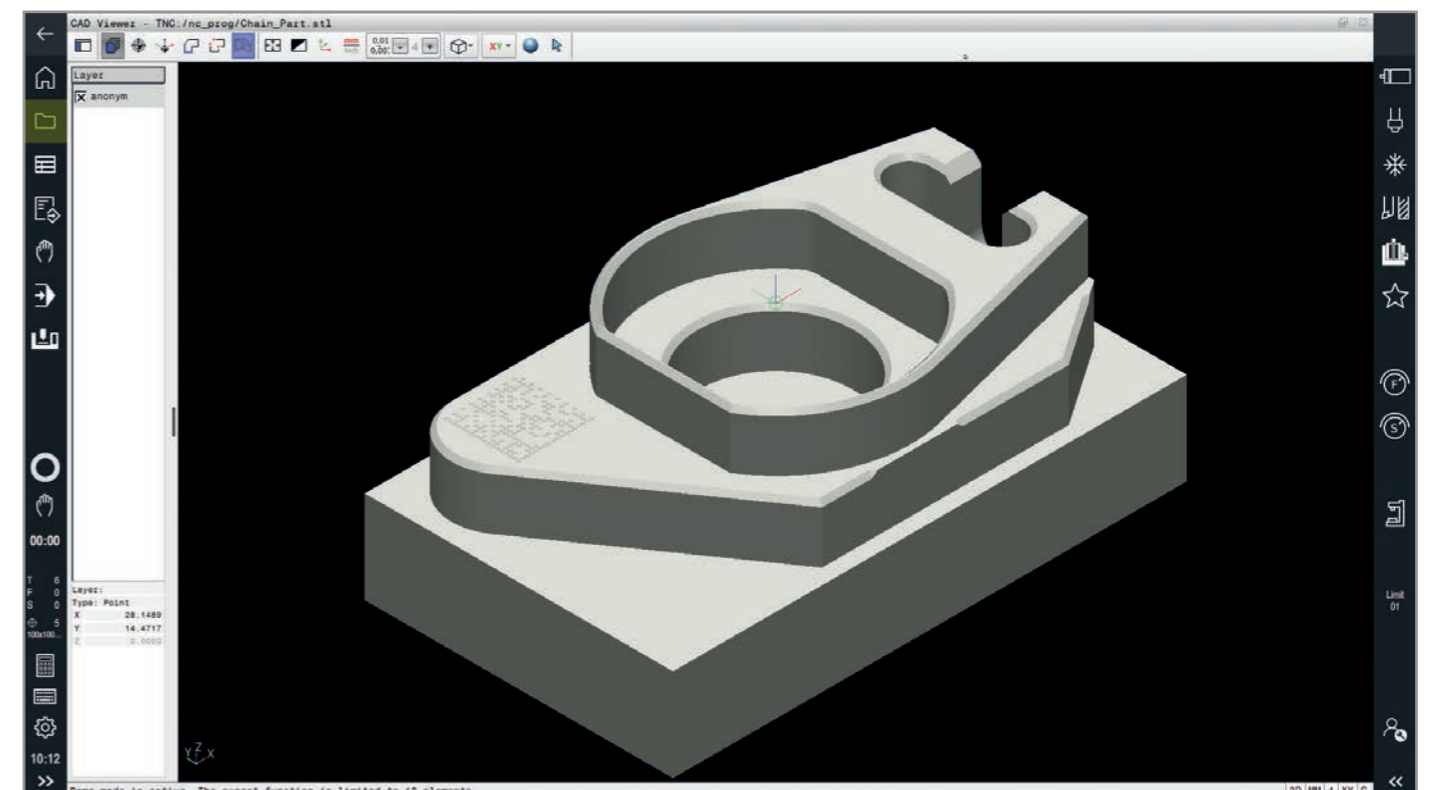

Intuitive and user-friendly

State-of-the-art multitouch operation

Monitor

The 16-inch Full HD screen shows a clear overview of all relevant information for programming, operating and monitoring the control. Along with its extensive functionality, the TNC7 basic provides maximum flexibility for everyday work. A user can optimally adapt the screen's content to his individual tasks, meaning that the TNC7 basic makes customized solutions possible that are perfectly adapted to the needs of a company, a team, or even individual users. The EmbeddedWorkspace offers even more information: alongside the usual workspaces, an additional workspace or an additional operating mode can be displayed. This makes it easy to seamlessly embed remote desktops or applications directly into the user interface of the TNC7 basic.

Operating panel

With its optimized operating design, the TNC7 basic sets new standards in terms of efficient and ergonomic work at the machine tool. The operating design of the TNC7 basic is fully touch-optimized. You can rotate images, select functions, and navigate, all with dynamic tapping and swiping motions on the touchscreen. But you still have the convenience and ergonomics of using a keyboard and trackball if desired. The keys of the machine operating panel are designed for precise operation of machine functions. Comments can also be easily entered using the alphanumeric keypad. Thanks to the reduced depth of the keyboard, the user is closer to the control screen. All screen areas are thus within hand's reach, which is ideal for operating the touchscreen ergonomically.



1. **TNC bar** with a "Go back" command, operating modes, status overview, calculator, on-screen keyboard, settings, date and time
2. **Information bar** with the active operating mode and a message menu
3. **Application bar** with tabs for opened applications, selection menu for workspaces
4. **Workspaces**
5. **Machine manufacturer bar**
6. **Function bar** with buttons and selection menu for buttons
7. **Standard keyboard** for comments and a set of PC keys for controlling operating system functions
8. **USB port** for additional data storage or other pointing devices
9. **Trackball and mouse buttons** for easy operation
10. **Axis-selection keys and numeric keypad**
11. **Function keys** for programming modes, machine operating modes, TNC functions, management, and navigation
12. **Override potentiometers** for feed rate and spindle speed
13. **Machine operating panel** with snap-on keys and LEDs

Ergonomic and sturdy design

The anodized finish on the keyboard unit is highly resilient to chemical and mechanical factors. The engraved keyboard lettering, such as on the potentiometer scale, exhibits high scratch and abrasion resistance.

Full-fledged touch operation

Touch gestures are perfect for operating the TNC7 basic. The high-performance user interface reacts quickly to input. The touch control is as smooth, precise and familiar as that of a smartphone or tablet PC. You can also use familiar gestures to smoothly reposition or zoom in on complex 3D models.

The workpiece and work envelope are virtually simulated for every task, thus providing the user with continuous 3D visualization support. Rounding off the TNC7 basic design are operating components with optimized ergonomics for working at the machine.

Practical touchscreen

With an IP54 rating, the touchscreen is designed to handle harsh shop conditions thanks to these characteristics:

- Dust-protected
- Splash-proof
- Scratch-proof

To clean the screen, simply select the touchscreen cleaning mode. This locks the screen to prevent unintended operation.

Gestures for multitouch operation

You can operate the screen of the TNC7 basic with gestures already familiar to you from your smartphone or tablet. For example, you can zoom in or out with two fingers, or swipe to rapidly navigate through menus.

Symbol	Gesture
	Tap
	Double tap
	Long press
	Swipe
	Drag
	Two-finger drag
	Spread
	Pinch

Highly practical user interface

The key to safe and low-fatigue work is having an intuitive screen layout and an ergonomic, well-arranged keyboard. Although HEIDENHAIN has been adhering to these principles for a long time, the TNC7 basic offers a number of features that make working with the control even simpler and easier than before.

Different tasks require individualized work environments, and the TNC7 basic lets you customize your screen content as desired. The users store favorites and decide for themselves where important status information or workspaces are shown: to the entire shop, to separate teams, or to each individual user. Depending on the respective application, certain contents can be given more emphasis while others are relegated to the background or even hidden. Also, the possible settings are easily reached, since they are not hidden in the depths of machine parameters. With the help of configurations, each user can save and activate individual modifications to the control interface.

The user interface of the TNC7 basic is designed to optimally assist you in your daily work, making results fast and easy to attain. Based on fillable forms and dialog guidance, it delivers optimal operating convenience and navigation. The TNC7 basic achieves this level of performance thanks to its touch-operated software. You can rotate images, zoom in and out, select functions, and navigate, all with dynamic tapping and swiping motions on the touchscreen.

Leading-edge design

The user interface of the TNC7 basic boasts a sleek outer appearance with a task-oriented structure and a pleasingly uniform font. The different screen areas are clearly delineated, and the operating modes are indicated by special operating mode symbols. The TNC bar and the information bar give you a perfect overview for confident navigation. The TNC7 basic lets you individually arrange the TNC and OEM bars, such as for switching between right-handed and left-handed operation.

The new Dark mode improves readability on the touchscreen of the TNC7 basic so that the user can operate the control in a relaxed manner even with low ambient lighting. To help you evaluate the priority of error messages, the TNC7 basic displays them in color-coded categories. A color-coded warning triangle is also displayed. Programming errors are even highlighted directly within the NC program.

The smartSelect functions overview

With dialog guidance you quickly and easily choose functions from a central window. A tree structure shows all of the subordinate functions that can be defined in the control's current operating state. In the left part of the window, the TNC displays favorites and recently called functions. That makes it very easy for you to mark frequently used functions as favorites. There are also NC functions for defining path functions, labels, tool calls, and cycles, as well as for special functions, parameter functions and miscellaneous functions.

Simple operation

New users will quickly find their way, thanks to the task-oriented operating modes and the perfectly designed visuals. Experienced TNC users will also be on familiar territory, since the well-proven function keys for navigation, operating modes and axis selection, for example, are still there. Along with being very intuitive, the TNC7 basic also provides brief training videos where new functions are clearly explained step-by-step.

A special feature of the TNC7 basic is its Home operating mode, which gives you simple and direct access to functions that are important to you. Two examples of this are the search function and a selection of frequently used favorites. By being able to define files, cycles, status parameters, etc. as favorites, you always have the necessary files and applications within easy reach. Naturally the common keyboard shortcuts, such as for copying, pasting and undoing, are always at your fingertips.

Straightforward program layout

The content of a program line can be quite extensive:

- Line number
- Program function
- Input value
- Comment

To make sure you always keep an overview even in complex programs, the TNC7 basic displays the individual program elements in different colors. This allows you to see at a glance which input values are editable. On the TNC7 basic, you can open more than one NC program at a time, for example in order to compare contents and copy them from one program to another.

The structuring function facilitates precise and efficient navigation within an NC program. The control creates a structure with configured elements, such as tool change, NC functions, and cycles. You can then use these structure items to jump directly to the corresponding location in the NC program. Additionally, program calls (CALL PGM) can be opened as new tabs.

The NC sequences feature of the TNC7 basic ensures especially convenient programming. The user can store any frequently-used sections of NC programs and insert them in other programs at any time.

File and table management

The file management of the TNC7 basic lets you open multiple folders and switch between the windows as desired. The copy, paste, undo and redo functions are also available here. If you accidentally delete any files, you can restore them from the recycle bin. In the table management you can open multiple tables and switch between them at any time. The table editor offers numerous practical features. For example, in the tool management you can use the sort and search function to sort all tools according to their various tool types. By selecting favorites, you can individually customize your table forms any time you want.

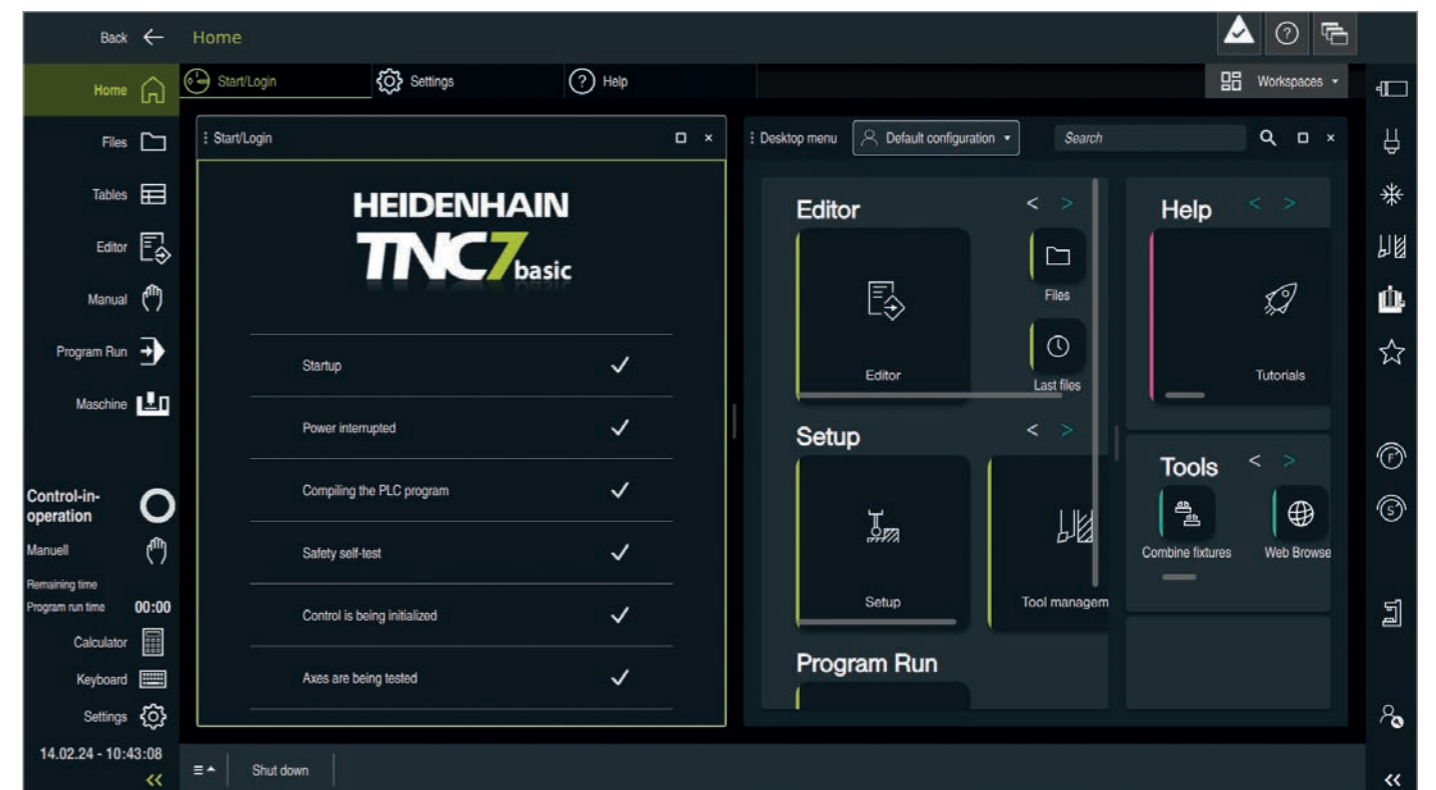
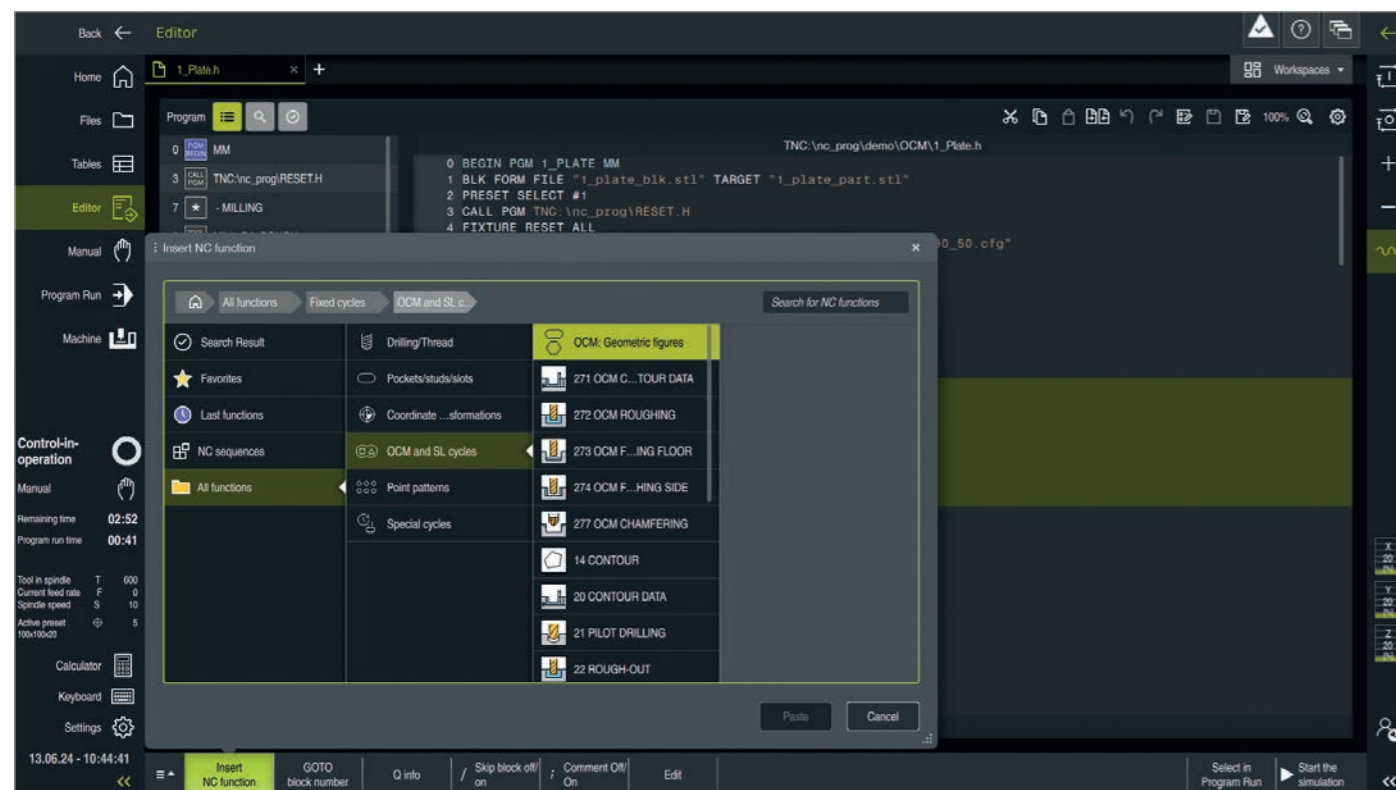

Programming, editing and testing

A full range of possibilities with the TNC7 basic

Programming at the machine

HEIDENHAIN controls are designed for shop-friendly programming right at the machine. Instead of requiring you to know G-codes, the Klartext conversational programming language provides its own buttons and keys for programming straight lines, arcs and cycles. At the push of a button, HEIDENHAIN Klartext dialog guidance opens and actively helps you during programming on the TNC. Unambiguous questions and prompts help you enter all the required information.

The TNC7 basic also offers form-based programming, where you enter syntax elements or cycle parameters with dialog guidance in clearly structured forms. Along with the proven path functions, the TNC7 basic also features graphical contour programming, with which you can very easily program contours that are not dimensioned for NC.

The TNC7 basic can also handle ISO programming (with G codes): you can run ISO programs or edit them with the alphanumeric keyboard.

The *Documents* workspace assists the user in a paperless production process. Image files, videos, text files, PDFs and HTML files can be displayed anywhere on the control's screen. For example, dimensional information can then be copied from the opened document to the NC program.

If you detect an error during the simulation, you can directly edit the NC program without having to switch the operating mode. You decide on the size and arrangement of the program windows, simulation windows, etc., based on your own requirements.

Multiple programs can be open simultaneously on the TNC7 basic. Naturally you can also copy parts of programs from an opened program to another program. The "program comparison" function of the TNC7 basic is a very practical feature for finding differences between NC programs. You can even copy the program sequences into the active NC program as required.

Also, with this function you can compare unsaved program changes with the last saved version of the program.

All interface texts, including Klartext tips, dialog prompting, program steps, and buttons, are available in numerous languages. Just like with all other HEIDENHAIN controls, the greatest possible compatibility was also emphasized for the TNC7 basic. Already existing NC programs and tool tables of the TNC 640 and TNC 620 can easily be incorporated. Programs from older TNC controls also run on the TNC7 basic, but some slight modifications might be necessary.

Individual machining steps

You don't need to create a complete program in order to start machining with the TNC7 basic. You can machine a workpiece step-by-step using both manual machining and automatic positioning in any sequence.

Minimize setup times

The TNC7 basic makes setup easy

Before machining can begin, the workpiece must first be clamped, the machine must be set up, the position of the workpiece in the machine must be determined, and the preset must be set. This is a time-consuming but indispensable procedure because any error directly reduces the machining accuracy. Particularly in small and medium-sized production runs, as well as in the case of very large workpieces, setup times become a significant factor.

The TNC7 basic features application-oriented, real-world setup functions that assist the user, help reduce non-productive time, and enable overnight, unattended production. In conjunction with the touch probes, the TNC7 basic offers numerous probing cycles for automatic workpiece setup, setting the preset, and measuring workpieces and tools.

The TNC7 basic simplifies machine setup thanks to manual, smart probing functions. Via a button menu, the user can select the desired probing function. The probing functions then provide step-by-step guidance through the measuring task, with intuitive user guidance, context-sensitive help images, and a clear presentation of the probing results.

The TNC7 basic supports L-shaped styli in the probing cycles, which are used to quickly and easily probe undercuts.

Fine manual axis control

During setup, you can use the axis-direction keys to move the machine axes manually or with an incremental jog. A simpler and more reliable way, however, is to use the electronic handwheels from HEIDENHAIN. With these handwheels, you are always close to the action, enjoy a close-up view of the setup process, and can control the infeed responsively and precisely.

Adapting the probing speed

In many cases, the workpiece must be probed at unseen positions or in cramped spaces, and the standard probing feed rate is usually too fast for this. In such situations, you can use the override knob to change the feed rate during probing without affecting the accuracy.

Workpiece alignment (option)

The HEIDENHAIN touch probes and probing functions of the TNC7 basic reduce the need for tedious manual alignment of the workpiece:

- You start by simply clamping the workpiece in any position.
- The touch probe determines the actual clamping situation by probing a surface.
- The TNC7 basic compensates for this misalignment with a "basic rotation," either by rotating the NC program to the ascertained angle or by correcting the actual misalignment through a turn of the rotary table.

The TNC7 basic offers you a comprehensive package of cycles for setting up the machine tool:

- Manual, automatic, and semiautomatic cycles for presetting and for compensating for misalignments in two or three dimensions
- Automatic probing cycle for repeating a measurement along a line
- A cycle with graphical support for calibration of fixtures
- Manual and automatic cycles for workpiece and tool measurement
- Semiautomatic tolerance monitoring and actual-to-nominal value transfer

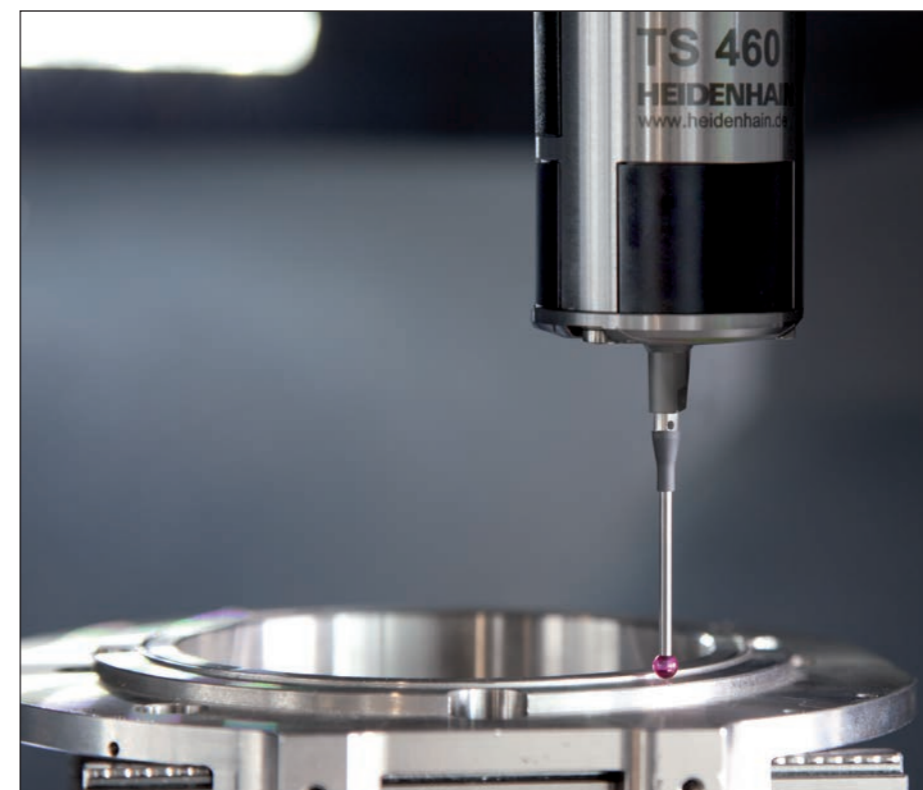
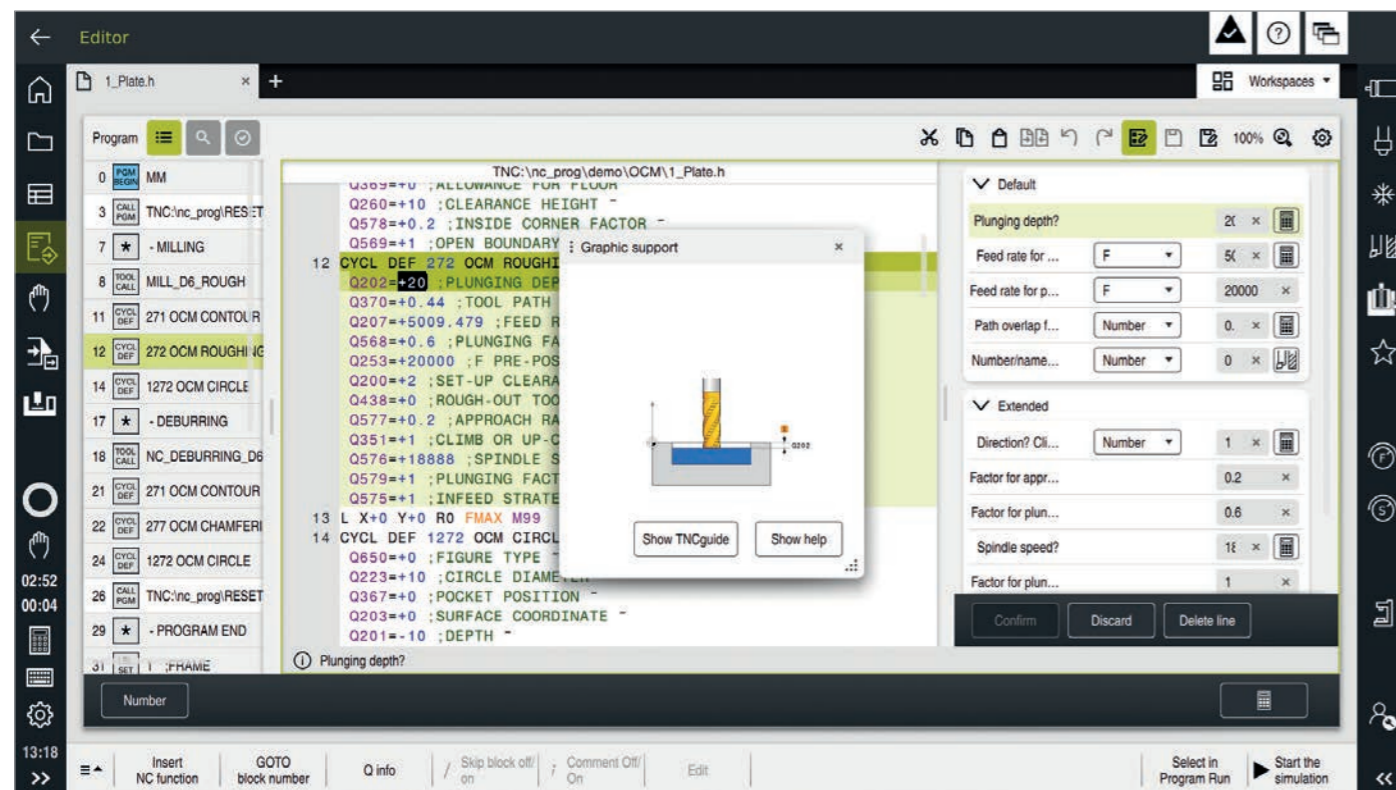

Setting presets

A preset allows you to assign a defined value displayed by the TNC to any position on the workpiece. Finding this point quickly and reliably reduces non-productive time and increases machining accuracy.

The TNC7 basic features probing cycles for automatically setting presets. Ascertained presets can be saved as follows:

- Using the preset management
- In a datum table
- Through direct setting of the display

Preset management with the preset table

Preset management enables flexible machining, shorter setup times, and higher throughput. Setting up your machine is greatly simplified.

In preset management, you can save any number of presets and assign an individual basic rotation to each one. In order to permanently save fixed presets in the machine's workspace, you can also write-protect individual lines.

There are three possibilities for rapidly saving the presets:

- Manually in the Manual operation mode
- Via the probing functions
- With the automatic probing cycles

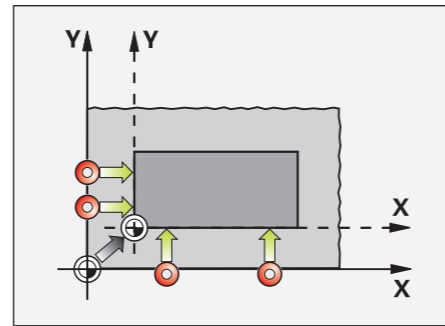

Setting a preset on a corner, for example, or in the center of a circular stud

Model Aided Setup (option)

For single parts and small lot sizes without a special holder, the position of the workpiece blank almost always needs to be ascertained before machining. With this intuitive probing function, the TNC7 basic offers the possibility of setting up workpieces quickly, easily and safely with graphic guidance. The exact position of the workpiece blank is measured in the machine's working space and reported to the control. The simulation view depicts a 3D model of the workpiece blank in the machine's working space. After the user has roughly aligned the model manually, a green arrow indicates that the model is ready to be probed. The axis keys or the electronic handwheel are used to position the touch probe to the blank in order to record the touch points. The

control automatically selects the probing direction. All of the six degrees of freedom can thus be measured with only one single function. During the entire setup process, the control informs the user about the quality of the probing points for determining the position and orientation of the workpiece. The user can thus quickly see when the measurement of the actual position and orientation of the workpiece is complete. The user can also move the rotary axes during the setup procedure in order to probe undercuts, inclined surfaces, or rounded surfaces, for example. This allows the user to align even complex workpiece blanks relative to pre-machined features, such as is needed for mold repair or 3D-printed workpiece blanks.

NO	DOC	X	Y	Z	SPC	SPB	SPA	LOCKED
0		0	0	300	8.65049	0	0	
1	50x50x60	0	0	336	0	0	0	
2	50x50x60	-25	-25	336	0	0	0	
3	60x60x60	0	0	336	0	0	0	
4	60x60x60	-30	-30	336	0	0	0	
5	100x100x20	0	0	276	0	0	0	
6	100x100x20	-50	-50	276	0	0	0	
7	100x100x40	0	0	296	0	0	0	
8	100x100x40	-50	-50	296	0	0	0	
9	100x100x70	0	0	326	0	0	0	
10	100x100x70	-50	-50	326	0	0	0	

Set up the workpiece

XY Clamping plane:

Axis	Value	+	++
X	0.000	+	++
Y	0.000	+	++
Z	340.000	+	++
SPC	0.000	+	++

Simulation view showing a 3D model of a cylindrical workpiece being probed by a touch probe. The interface includes a 'Selection' panel on the right with options for Machine, Workpiece, and Clamping situation.

Automated machining

The TNC7 basic measures, manages and communicates automatically

The requirements gap between machining centers and typical tool and moldmaking machines is becoming ever narrower. The TNC basic is also very capable of controlling automated manufacturing processes. It features the necessary functionality to initiate the proper machining operation in concatenated machining scenarios with individual workpieces in any workholding arrangement.

Automated inspection of workpieces for proper machining and dimensional accuracy (option)

The TNC7 basic features numerous automatic measuring cycles for inspecting the geometry of machined workpieces. This requires inserting a touch probe from HEIDENHAIN into the spindle in place of the tool. This allows you to do the following:

- Recognize a workpiece and call the appropriate part program
- Check whether all machining operations were conducted correctly
- Determine infeeds for finishing
- Detect and compensate for dimensional deviations

- Inspect workpiece geometry and sort parts
- Log measured data
- Ascertain the machining trend
- Check tolerances and configure various reactions, such as an error message

Milling-tool measurement and automatic compensation of tool data (option)

In conjunction with the TT tool touch probe, the TNC7 basic lets you automatically measure milling tools in the machine. The TNC7 basic then stores the determined values, such as tool length and radius, in its tool memory. By inspecting the tool during machining, you can quickly detect tool breakage as well as wear through dimensional deviations of the tool contour, thus preventing scrap and rework. If the measured deviations lie outside the specified tolerances or if the monitored tool life has been exceeded, the TNC7 basic locks the tool and automatically inserts a replacement tool.

Tool management*

For machining centers with automatic tool changers, the TNC7 basic offers a central tool memory for any number of tools. This tool memory area is a freely configurable file that can be optimally adapted to your needs. You can even have the TNC7 basic manage your tool names. The control prepares the next tool change while the current tool is still cutting. This significantly reduces the non-cutting time required for tool changes.

With the tool manager, the control now shows only the required input fields based on the selected tool type. Any data can also be graphically depicted. The Extended Tool Management option now also includes the "Tooling list" table and the "T usage order" table. These tables enable you to detect the tool requirements in time and thus prevent interruptions during program run.

* The control must be adapted for these functions by the machine manufacturer.

Pallet management and serial machining

Pallet management

Pallet management functionality lets you automatically machine workpieces in any order. Upon insertion of the pallet, the correct machining program and preset are automatically selected. You can also apply coordinate transformations and measuring cycles in the part programs. A pallet counter function lets you easily define the desired quantity to be produced.

Batch Process Manager (option)

Batch Process Manager is a powerful function for pallet machining and series production. Its straightforward user interface helps you plan your production process and gather important information on upcoming machining operations.

Batch Process Manager automatically checks for missing tools, insufficient tool life, and required manual tool changes. The results are displayed in the status overview.

Batch Process Manager shows the following information before beginning the machining operation:

- The time of the next manual intervention
 - Run time of NC programs
 - Availability of tools
 - Correctness of NC program
- Additionally, the TNC7 basic can actively check for collisions in all pallet subprograms during program run (requires the Collision Monitoring or Collision Monitoring v2 software option).

Tool-oriented machining

In tool-oriented machining, a single machining step is performed on all of a pallet's workpieces before moving to the next machining step. This keeps the number of tool changes to a minimum and significantly shortens the machining time.

The TNC7 basic assists you with convenient fillable forms that allow you to assign a tool-oriented operation to a pallet with multiple workpieces. As always, you still write the machining program in the normal workpiece-oriented sequence.

You can also use this function even if your machine does not support pallet management. In this case, you simply define the position of the workpiece on the machine table in the pallet file.

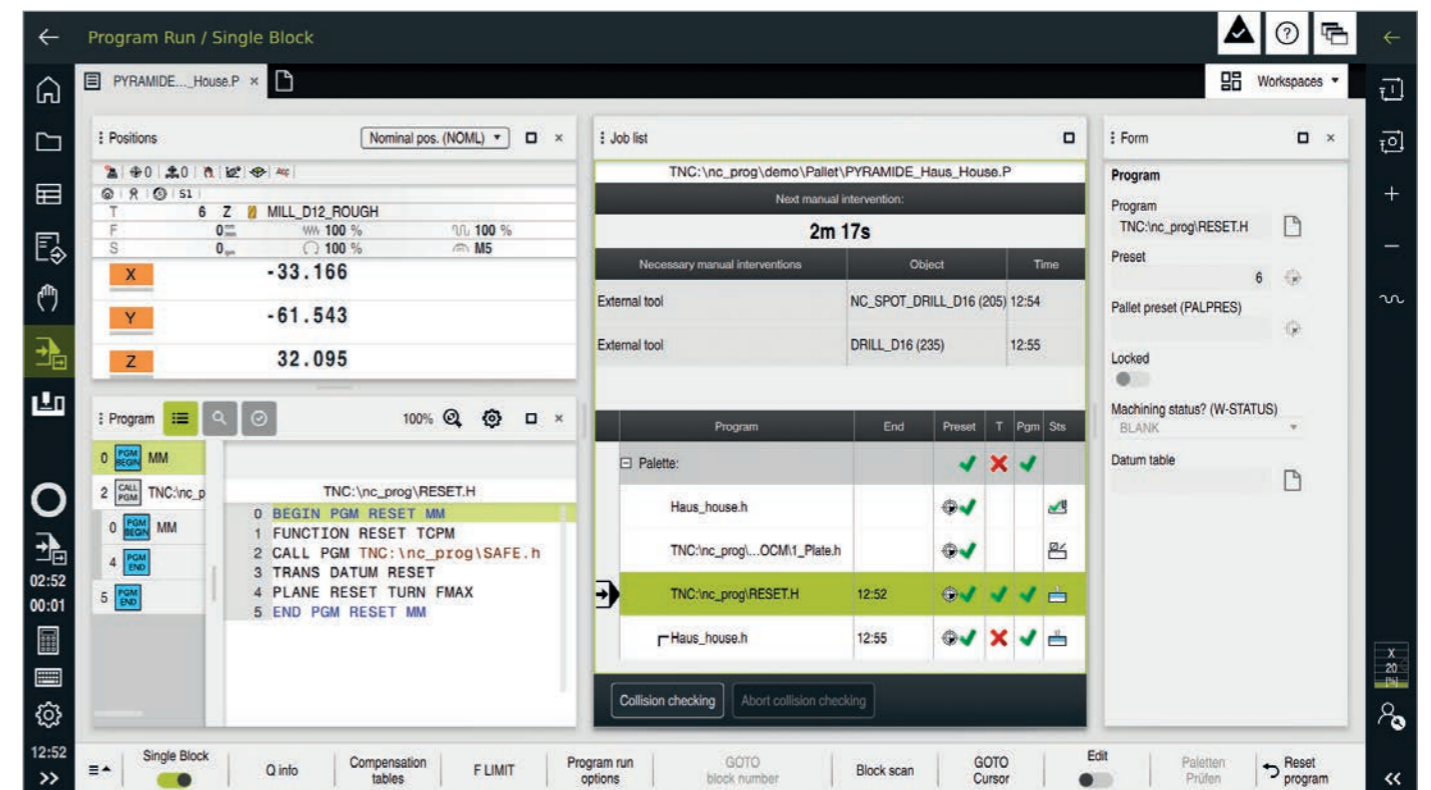

Intelligent machining

Dynamic collision monitoring (DCM, option)

The complex machine movements and normally high traversing speeds of five-axis machining make axis movements difficult to predict. This makes collision monitoring a valuable function that relieves the user and protects the machine from damage.

NC programs from CAM systems may be able to avoid collisions of the tool or tool holder with the workpiece but do not account for machine components in the workspace—unless you invest in expensive offline machine simulation software. But even then, there is no guarantee that the arrangement of machine components still matches the simulation. In the worst case scenario, collisions won't manifest themselves until the part is actually machined.

In these cases, the user is assisted by the TNC7 basic's dynamic collision monitoring* software option (DCM). The control interrupts the machining process whenever a collision is imminent, thus increasing safety for both the machine and its user. This, in turn, helps prevent damage to machines and workpieces, as well as any resulting costly downtime. Unattended shifts also become more reliable.

DCM is active not only while a program is being executed, but also during manual operation and in simulations. If an impending collision is already detected during workpiece setup, for example, the axis motion is stopped with an error message. You can combine multiple fixtures and store them as a new fixture. This allows you to visualize and monitor complex fixturing.

The fixture import function of DCM not only enables graphical representation of the fixtures, but also provides for collision checking during simulation and the actual machining process. An additional level of reliability is gained with the enhanced checking for collisions between the workpiece and the non-cutting part of the tool or the tool holder.

The machine manufacturer defines the machine components by using geometric shapes to describe the workspace and the collision objects. For tilting devices, the machine manufacturer can also use the description of the machine kinematics to define the collision objects.

The 3D format for collision objects offers further interesting benefits:

- Convenient data transfer of standard 3D file formats
- Fully detailed illustration of machine components
- Greater exploitation of the machine's workspace

The TNC7 basic can also monitor tool carriers such as holders for milling cutters or touch probe housings. To this end, a tool-carrier kinematic model is assigned to the tool in the tool table. When the tool is inserted, the respective tool carrier is activated in the collision monitoring function.

Because the machine design itself prevents collisions between certain machine components, not all of the machine parts require monitoring. For example, a HEIDENHAIN TT tool touch probe clamped to the machine table for purposes of tool measurement will never collide with the machine cabin. The machine manufacturer can therefore limit the machine elements that could collide with each other.

When using DCM, please note the following:

- DCM can help reduce the danger of collision, but DCM cannot completely prevent all collisions
- Only the machine manufacturer can define machine components
- DCM cannot be used in servo-lag operation (no feedforward)
- DCM cannot be used for eccentric turning

* The control must be adapted for these functions by the machine manufacturer.

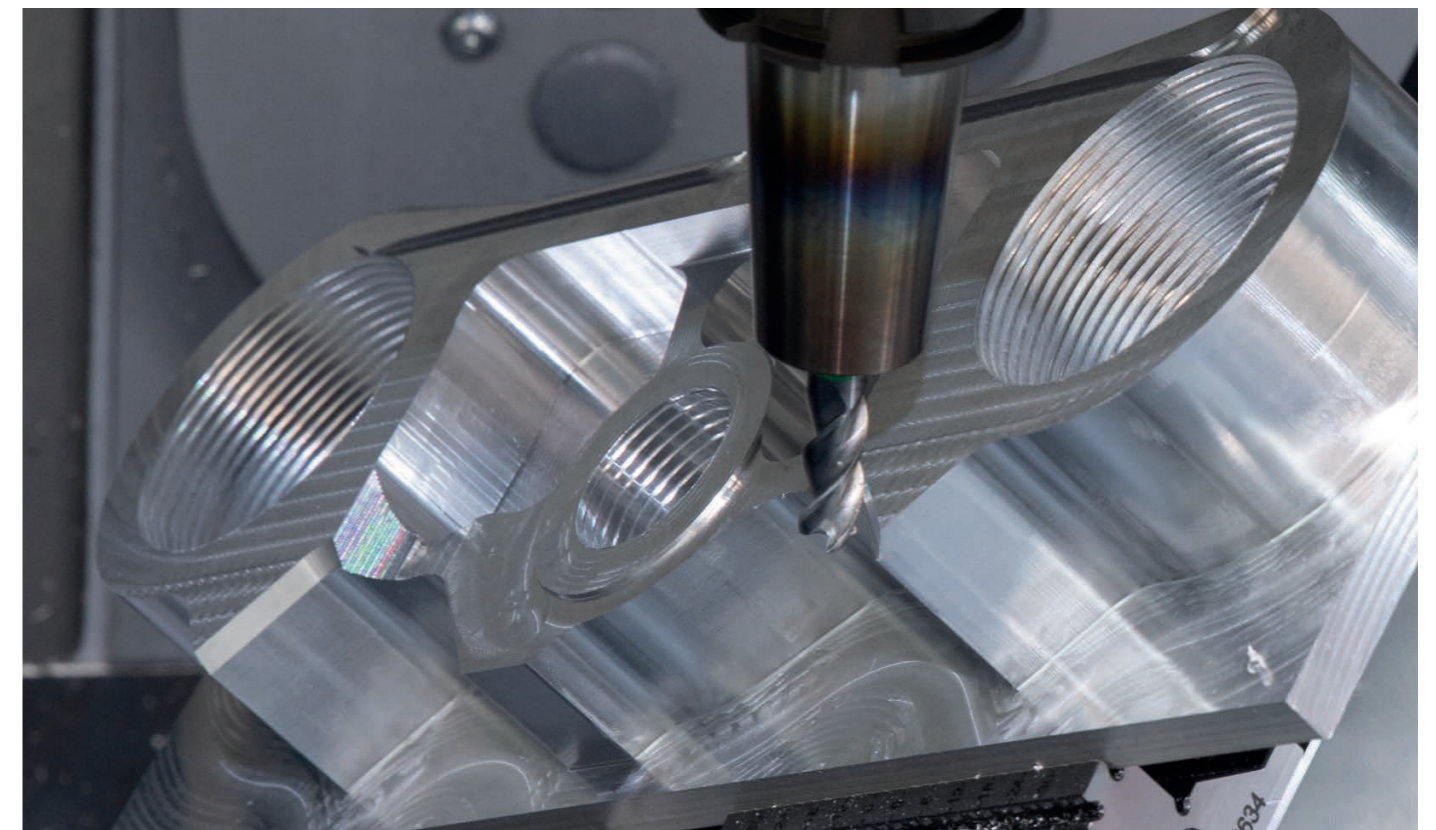
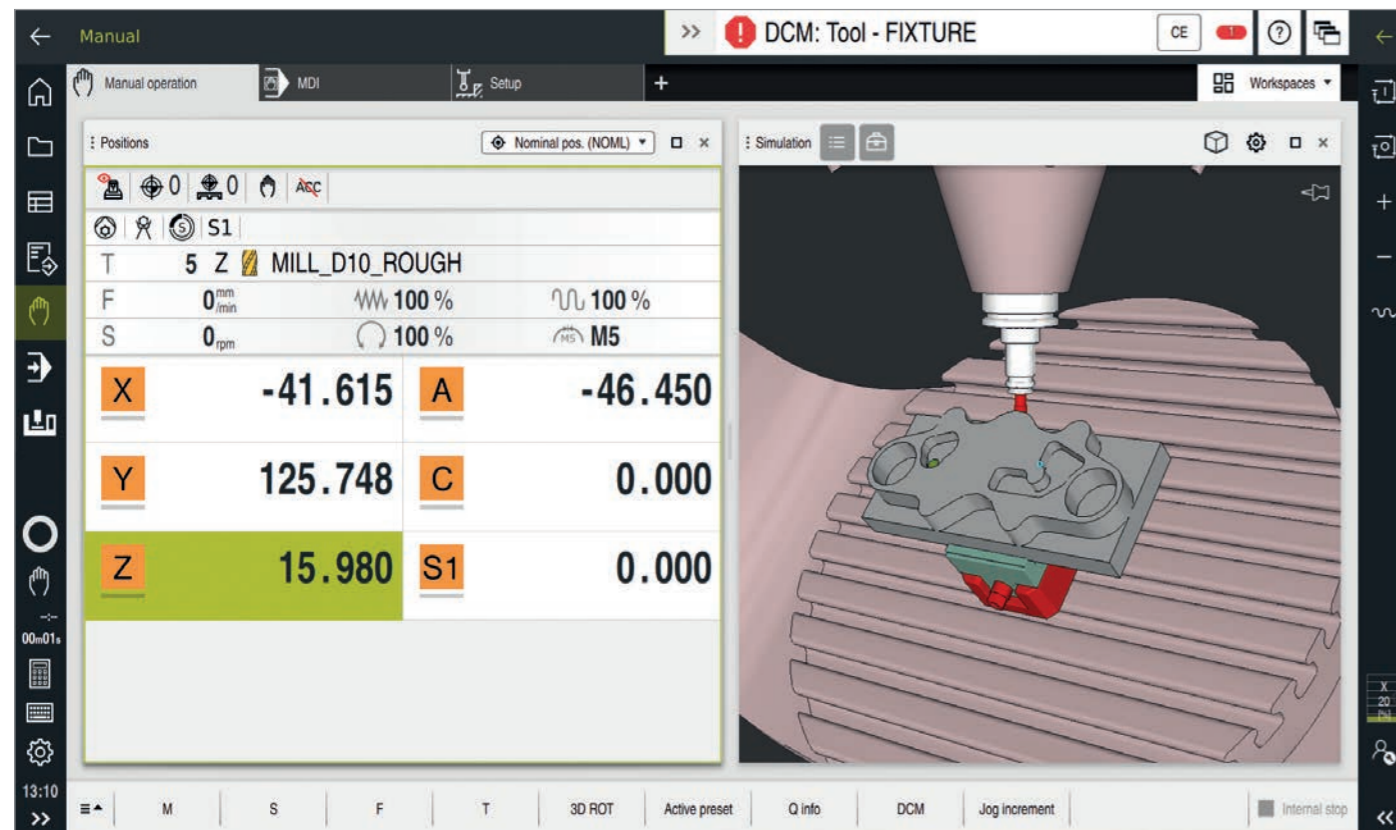

The expanded collision monitoring of the TNC7 basic not only prevents tools from colliding with machine components, but also with fixtures. A fixture that has been set up accurately is essential for machining close to the workpiece. The TNC7 basic features a special probing function that graphically and interactively assists you in determining the exact position of the fixture. That way you don't have to worry about either the sequence or the actual probing functions. Colored arrows in a virtualized work envelope show you whether the position is correct and the probing operation can be performed. This graphically supported measurement can be used for any workholding equipment. An accurate 3D model is all that is needed.

With DCM v2 it is possible to machine right up to the fixture. Where necessary, you can enter a value smaller than the standard 2 mm between the tool and the fixture by simply programming the monitored distance in the NC program.

- Integrate any tool shapes as STL files:
- Workpieces are monitored for collisions with the tool shaft
 - Ability to protect tools of any shape from collisions with fixtures and machine components
 - Realistic material-removal simulation
 - Use of tools with any measuring point (such as for measuring the rear cutting edge of backward deburrers)

The collision protection provided by DCM v2 is only as good as the data for the models of the collision objects. For reliable machine operation, the digital data must match the physical reality. The new import function of the OPC UA NC Server provides tool pre-setters and tool databases with functions for importing the 3D models of the tool and tool holder directly into the control. The model validation feature checks the 3D models during importing, thus ensuring maximum reliability of DCM and the simulation. The 3D tool models take collision protection and simulation to a new level.

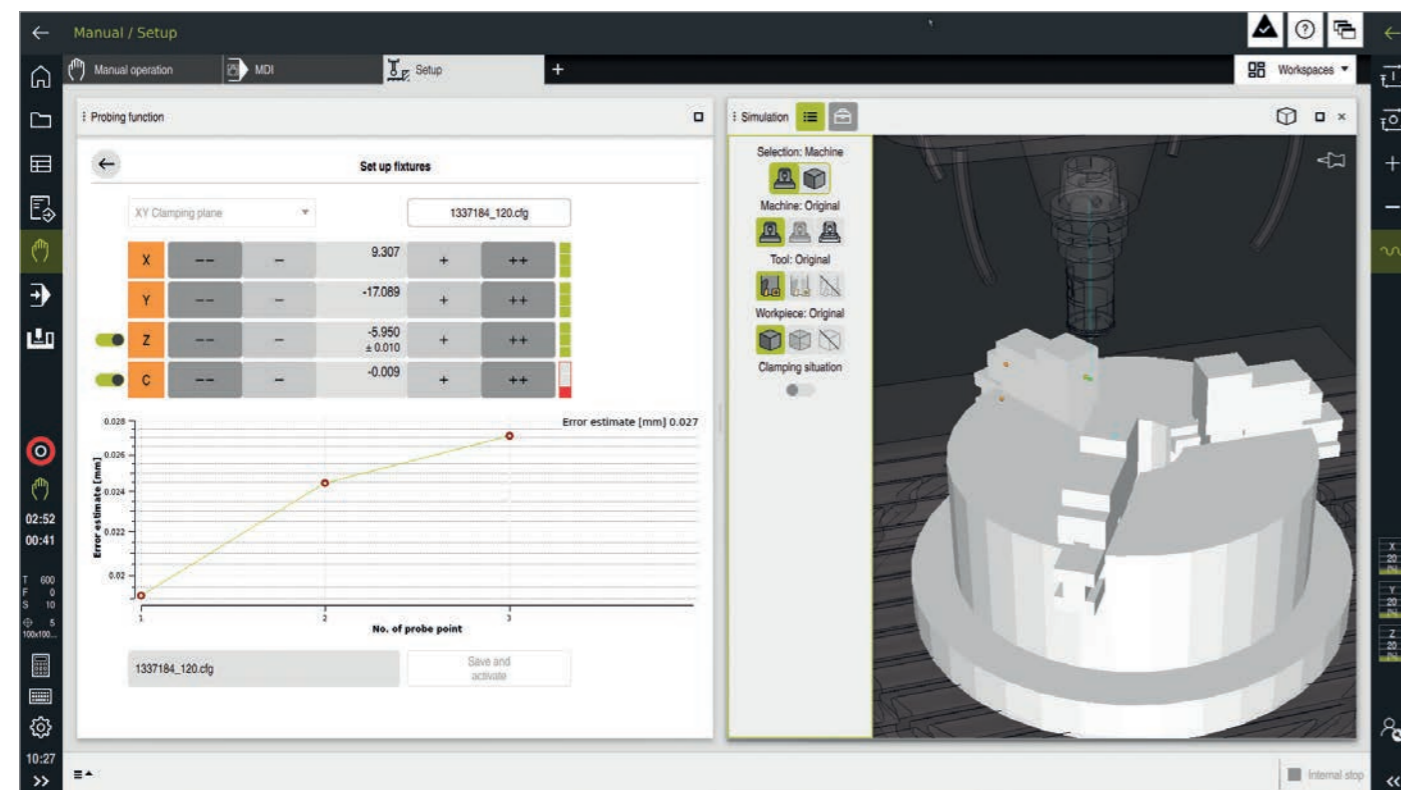

The TNC basic is designed for exceptional accuracy and surface quality at high machining speeds. Cycles and functions operating separately or in concert ensure perfect surface finishes in extremely short machining times:

- Optimized motion control
- Effective jerk reduction
- Dynamic contour look-ahead

The term Dynamic Precision covers a number of HEIDENHAIN cutting solutions that can dramatically improve the dynamic accuracy of a machine tool. These solutions shed new light on the competing demands of accuracy, high surface quality, and short machining times. The dynamic accuracy of machine tools manifests itself in the capability to minimize deviations in the relative motions between workpieces and tools. Arising deviations depend on kinetic quantities such as speed and acceleration (including jerk) arising from the vibration of machine components and other factors.

All of these factors contribute to dimensional inaccuracy and the formation of defects on the workpiece surface, thereby impacting both quality and productivity (in the case of quality-related scrap). Dynamic Precision counteracts any arising deviations with intelligent control technology to help improve the quality and dynamic performance of a machine tool. As a result, production time and cost are reduced.



dynamic + precision

Dynamic Precision contains the following functions, which can be deployed separately or in combination.

Function		Benefits
CTC Cross Talk Compensation	Compensates for acceleration-dependent position errors at the TCP	Greater accuracy during acceleration phases
MVC Machine Vibration Control	Damping of machine oscillations <ul style="list-style-type: none"> • AVD (Active Vibration Damping): Compensates for undesired effects of vibrations on the feed axes • FSC (Frequency Shaping Control): Suppresses the inducement of vibrations through a correspondingly filtered feedforward control 	A superior surface finish
CTC + MVC	–	Faster and more accurate machining
PAC Position Adaptive Control	Position-dependent adaptation of control parameters	Greater contour fidelity
LAC Load Adaptive Control	Load-dependent adaption of control parameters and the maximum axis acceleration	Higher accuracy whatever the load
MAC Motion Adaptive Control	Motion-dependent adaptation of control parameters	Less vibration and higher maximum acceleration during rapid traverse

High contour fidelity and surface quality
TNC controls from HEIDENHAIN are known for their low-jerk and speed/acceleration-optimized motion control, enabling optimized surface quality and workpiece accuracy. With the TNC basic, you are able to leverage the latest technological developments. The TNC7 basic anticipates and thinks along with you, dynamically calculating the contour ahead of time. In addition, special filters suppress machine-specific natural frequencies.

With its Look Ahead function, the TNC7 basic recognizes directional changes ahead of time and adapts the traversing speed to the shape of the contour and the surface to be machined. You simply program the maximum machining speed as the feed rate and, in Cycle 32 TOLERANCE, enter the maximum permissible deviations from the ideal contour. The TNC7 basic automatically adapts the machining operations to the tolerance that you define. This method prevents contour defects.

Advanced Dynamic Prediction (ADP) expands upon the previous look-ahead calculation of the permissible maximum feed rate profile. ADP compensates for differences in the feed rate profiles resulting from the point distribution on neighboring paths, especially in NC programs originating from CAM systems. Among other benefits, this results in particularly symmetrical feed rate behavior on the back-and-forth paths during bidirectional finish milling, as well as very smooth feed rate curves on neighboring milling paths.

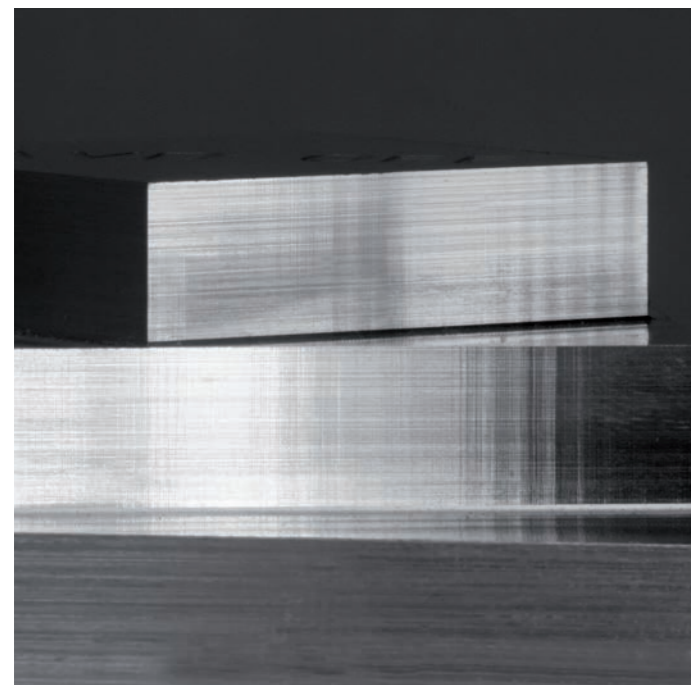

Vibration can significantly impair surface quality.

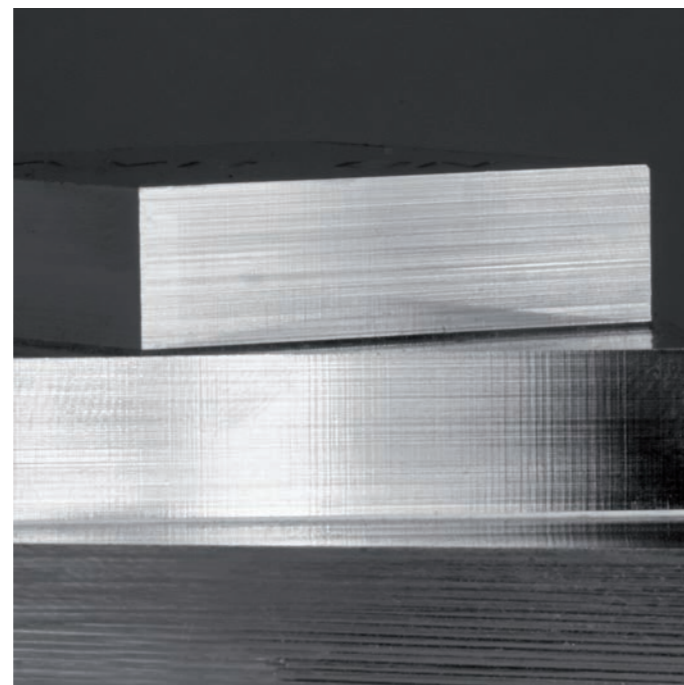

Visibly superior surface quality can be attained with MVC.

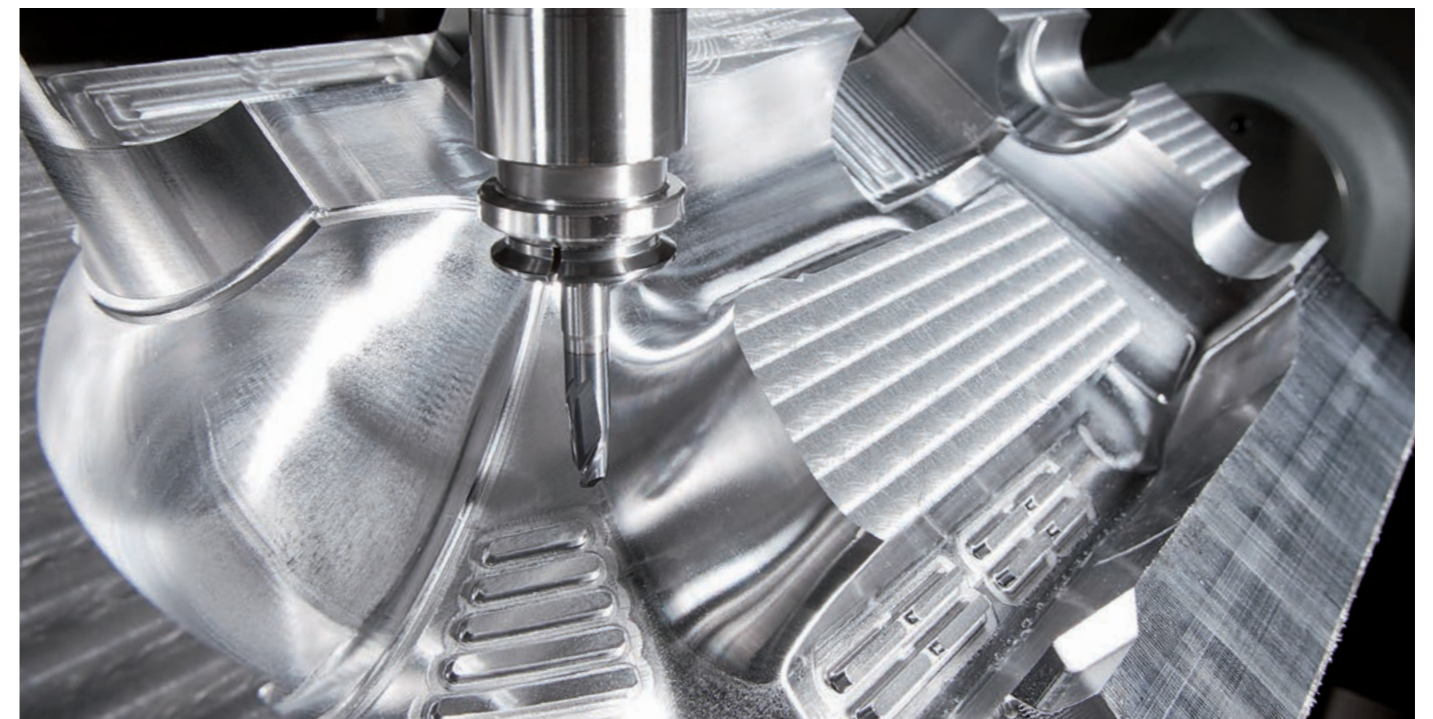

Fast machining and computing processes

With a short block-processing time of at most 1.5 ms, the TNC7 basic can run fast look-ahead calculations for optimal use of the machine's dynamic parameters. Functions such as ADP and Look Ahead therefore ensure not only high contour fidelity and surface quality but also optimize the machining time.

One basis for the TNC7 basic's high speed is its fully digital control design. This includes the integrated digital drive technology from HEIDENHAIN as well as digital interfaces connecting all of the control components with each other:

- Control components via HSCI (HEIDENHAIN Serial Controller Interface)
- Encoders over EnDat 2.2

As a result, exceptionally high feed rates can be implemented. To attain the required cutting speeds, the TNC7 basic digitally controls spindle speeds up to 100 000 rpm.

The TNC7 basic's powerful 5-axis machining capability even lets you economically manufacture complex 3D contours. Programs for such contours are usually created offline with CAM systems and typically contain numerous short line blocks that are transferred to the control. With its short block-processing time, the TNC7 basic quickly executes even complex NC programs. The control's computing power can handle complex look-ahead calculations in simpler NC programs as well. Thus, regardless of the data volume of the NC programs from your CAM system, the TNC7 basic will machine the workpiece to near-perfect conformity with your program.

Many five-axis operations that initially appear to be highly complex can be broken down into common 2D movements that have been tilted about one or more rotary axes or wrapped around a cylindrical surface. In order for you to create and edit such programs quickly and easily without a CAM system, the TNC assists you with helpful functions.

Tilting the working plane* (option)

Programs for contours and holes on inclined surfaces are often extremely complex and require time-consuming computing and programming work. In cases like these, the TNC7 basic can save you a great deal of programming time. You simply program the machining operation as usual in the working plane (e.g., in X/Y); the machine then performs the operation in a tilted plane.

The PLANE function makes it easy for you to define a tilted working plane: tilted working planes can be specified in seven different ways depending on the information available in the workpiece drawing. Help images assist you during program entry.

You can also use the PLANE function to define the positioning behavior during tilting to avoid unpleasant surprises when the program is run. The settings for defining the positioning behavior are identical for all PLANE functions, making operation much easier.

*The control must be adapted for these functions by the machine manufacturer.

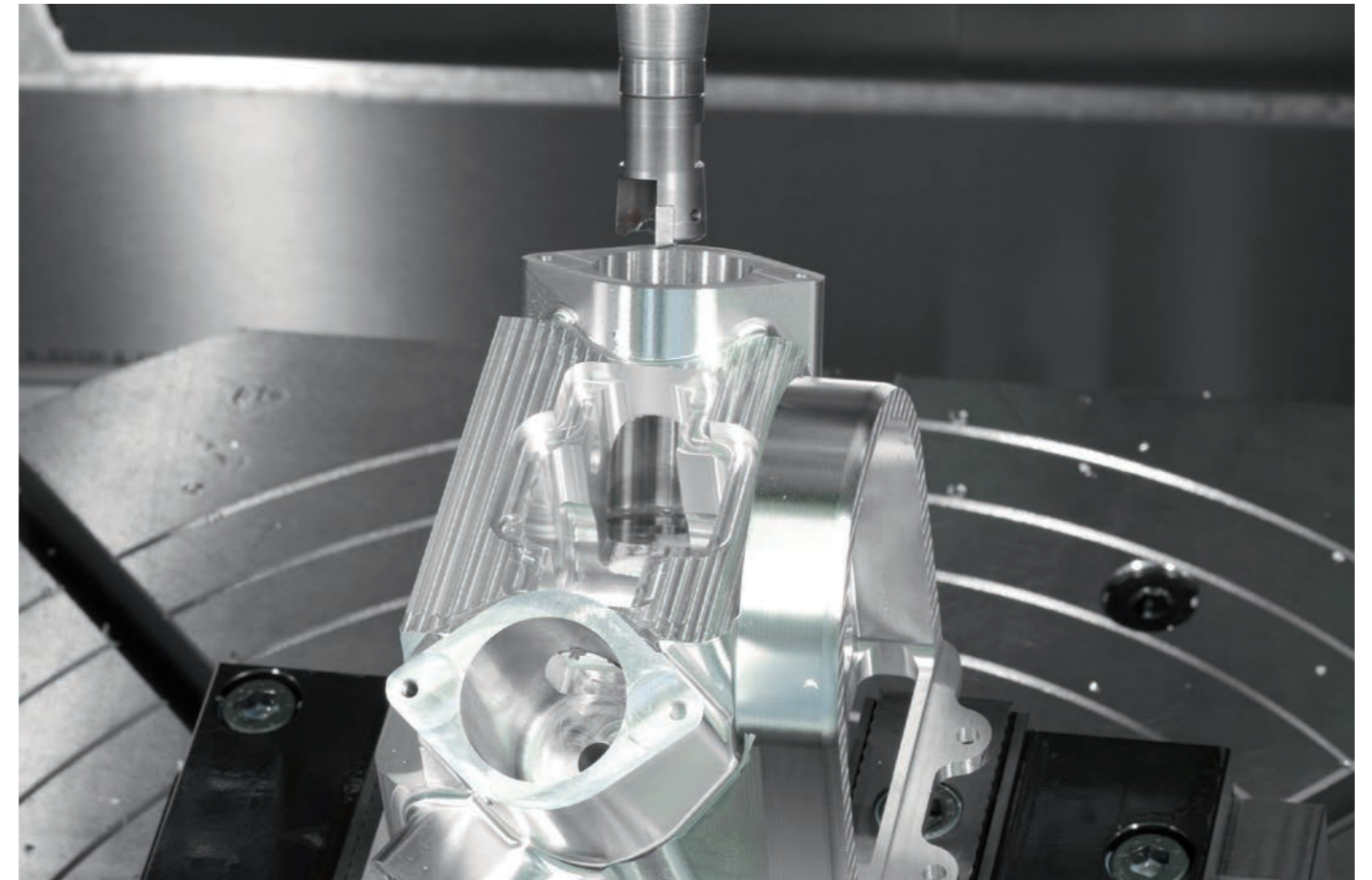
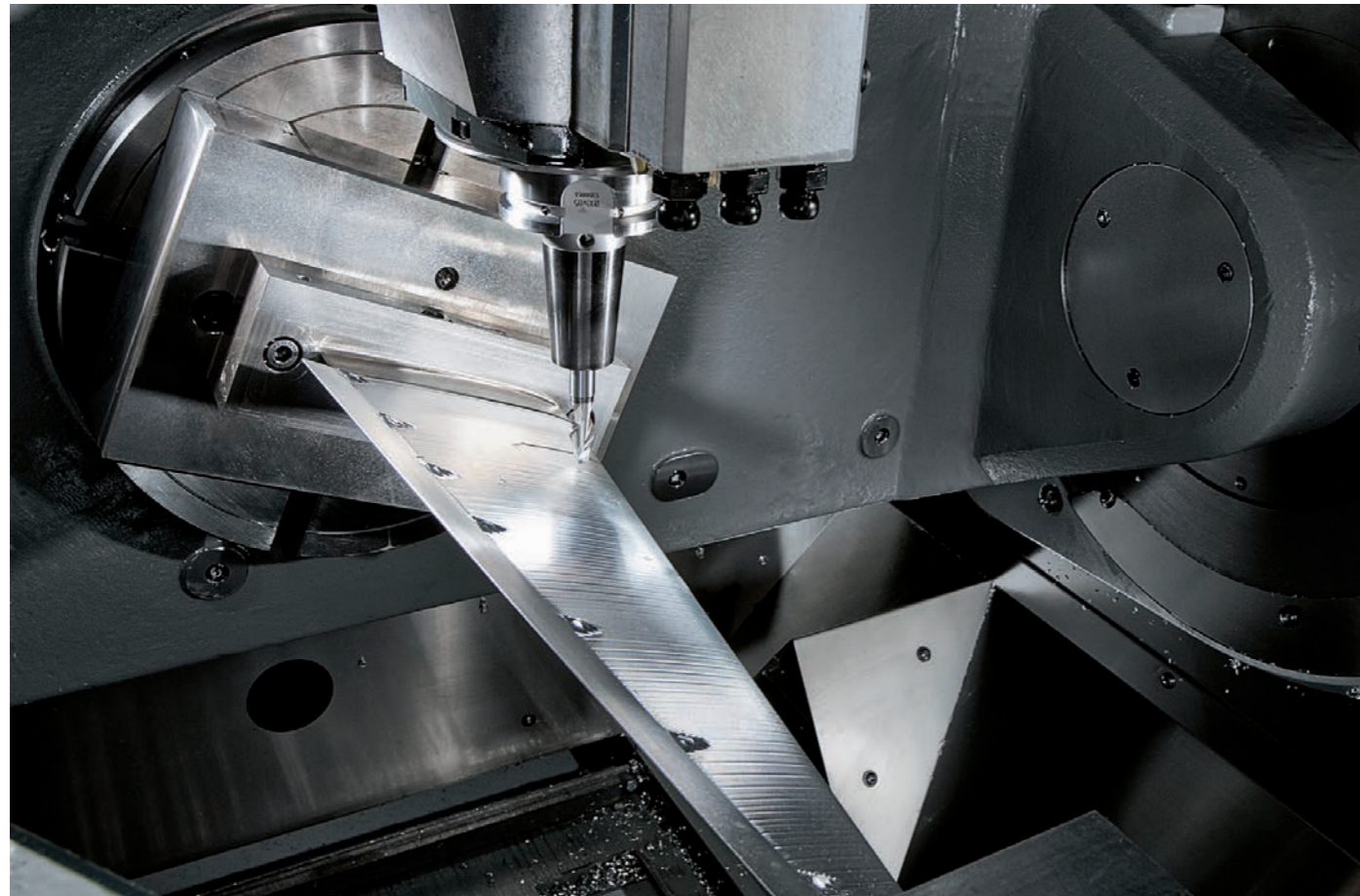

Inspecting and optimizing machine accuracy

Easy calibration of rotary axes with KinematicsOpt (option)

Manual axis motion in the tool direction on 5-axis machines

Correct tool retraction is very important in five-axis machining. The virtual tool axis function provides assistance by allowing you to move the tool in the direction of the tool axis using external direction keys or a handwheel. This function is especially useful if you want to

- retract the tool in the direction of the tool axis during an interruption of a five-axis machining program,
- use the handwheel or external direction keys to perform an operation in Manual mode with an inclined tool, or
- move the tool with the handwheel in the active tool axis direction during machining.

Feed rate for rotary tables in mm/min* (option)

By default, rotary axis feed rates are programmed in degrees/min, but the TNC7 basic can also interpret these feed rates in mm/min. The feed rate at the contour is then independent of the distance of the tool center point from the center of the rotary axis.

Cylinder surface machining* (option)

With the TNC7 basic it is quite easy to program contours (which consist of straight lines and arcs) on cylindrical surfaces using rotary and tilting tables: You simply program the contour in a plane as if the cylinder surface were unrolled. The TNC7 basic then executes the programmed machining operation on the cylinder surface.

The TNC7 basic provides four cycles for cylinder surface machining:

- Slot milling (the slot width and tool diameter are identical)
- Guide-groove milling (the slot width is greater than the tool diameter)
- Ridge milling
- Outside contour milling

* The control must be adapted for these functions by the machine manufacturer.



Accuracy demands are on the rise, particularly in the realm of 5-axis machining. Complex parts must be manufactured with both precision and reproducible accuracy, including over extended periods of time.

The KinematicsOpt software option is an important ingredient in helping you meet these high demands: with a HEIDENHAIN touch probe inserted, a cycle measures your machine's rotary axes fully automatically. The measuring process is the same, regardless of whether the rotary axis is a rotary table, tilting table, or a swivel head.

For calibrating the rotary axes, a calibration sphere is mounted at any position on the machine table and probed with the HEIDENHAIN touch probe. Prior to this, you define the resolution of the measurement and the range that you want to measure for each rotary axis.

Based on the measured values, the TNC calculates the static tilting accuracy. The software minimizes the spatial error arising from the tilting movements and, at the end of the measuring process, automatically saves the machine geometry in the respective machine constants of the kinematics description.

Of course, a detailed log file is also available in which the measured and optimized dispersion (measure of the static tilting accuracy) is saved along with the actual measured values and the actual compensation values.

Optimal use of KinematicsOpt requires a highly rigid calibration sphere for reducing the deformations caused by probing forces. For this purpose, HEIDENHAIN offers calibration spheres with highly rigid holders of various lengths.

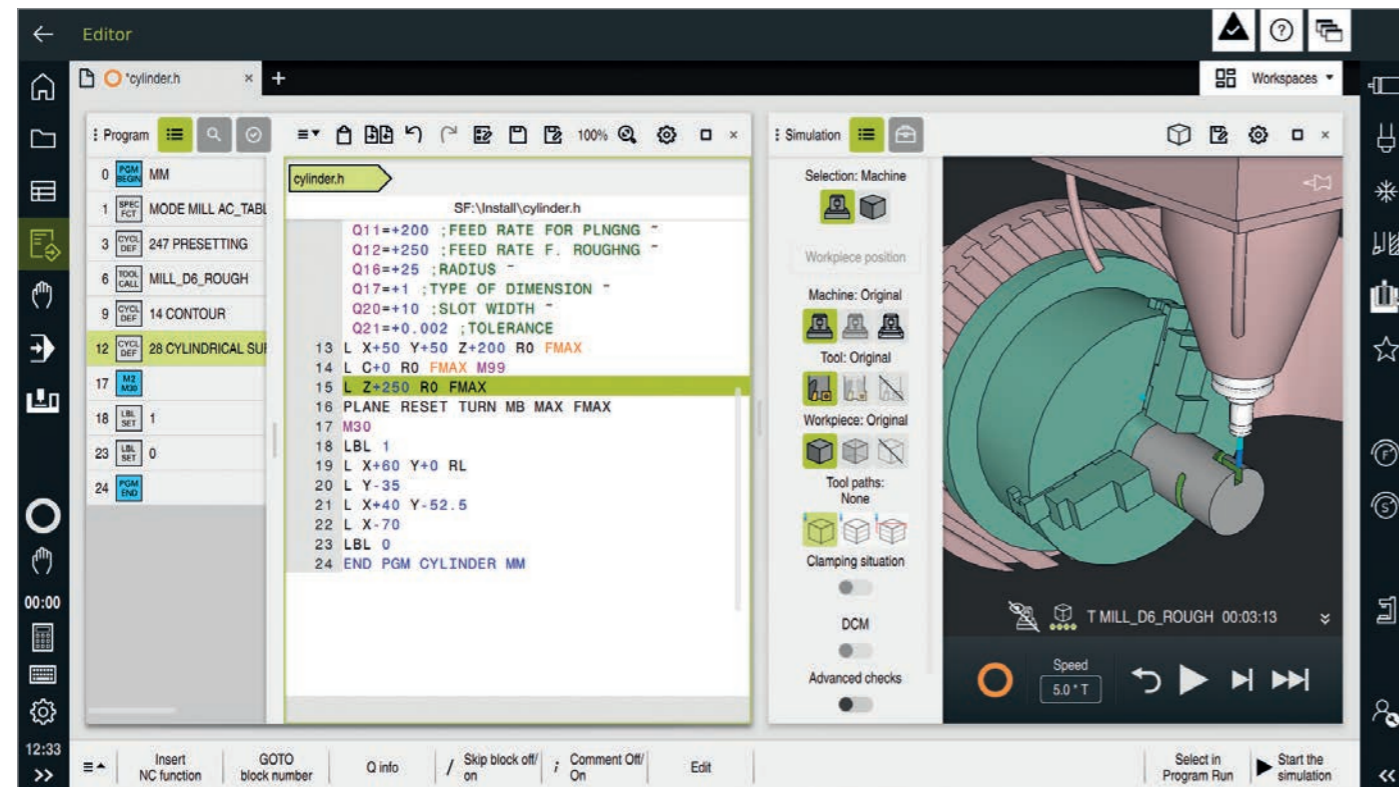

Component monitoring* (option)

Overload often leads to damaged machine components, and therefore to machine downtime. For example, the spindle bearing is often subject to a very high load in machining strategies that have been optimized for maximum efficiency, and can therefore sustain undetected damage. Component Monitoring warns you about these dangers, and can even stop the machine tool if necessary. Thanks to continuous monitoring of the bearing load and visualization of these values, the machining processes can be optimized correspondingly.

However, the production quality of a machine tool is influenced not only by overload. Components that are constantly under load, such as guideways or the recirculating ball

screw, are subject to wear and thus have an influence on the finished product. The TNC7 basic uses the Component Monitoring software option to measure and document the momentary machine status. The machine manufacturer can read and evaluate these data, and react using predictive maintenance, thereby avoiding unplanned machine downtimes. The MONITORING HEATMAP function within the NC program lets you color the concurrent material removal simulation in the workpiece view with the status of a monitoring task. That way you see in the workpiece view where a component is subject to an excessive load.

*The control must be adapted for these functions by the machine manufacturer.

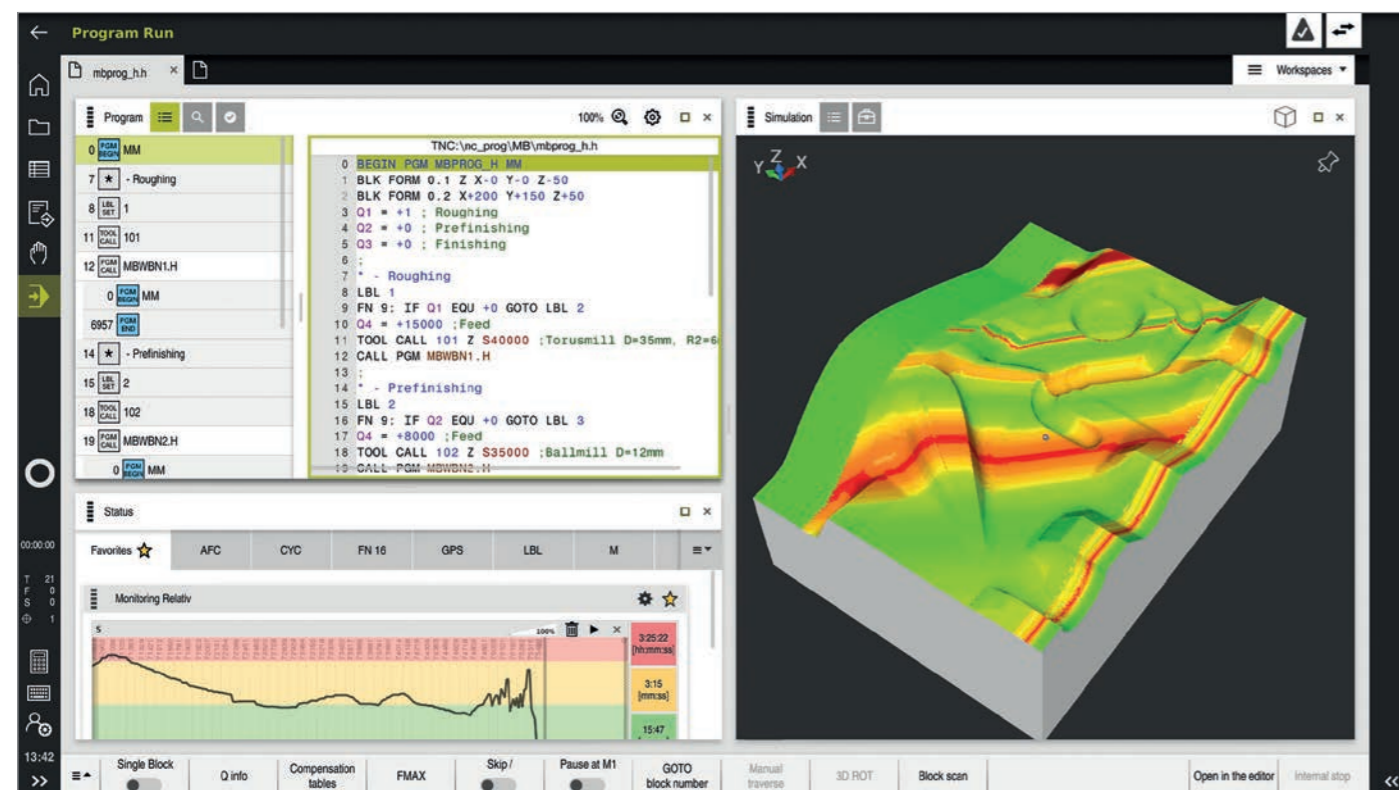

Programming 2D contours

Two-dimensional contours are the bread and butter of a modern machine shop, which is why the TNC7 basic offers a variety of ways to handle them.

Programming with function keys

Are the contours properly dimensioned for NC machining? In other words, are the end points of the contour elements provided in either Cartesian or polar coordinates? If yes, then you can create the NC program straightaway using function keys.

Straight lines and circular elements

To program a line segment, for example, simply select the "linear traverse" path function. The Klartext conversational programming language of the TNC basic then prompts you for all of the information needed by the programming block, including the target coordinates, feed rate, tool compensation value, and machine functions. Functions for circular movements, chamfers, and corner rounding also simplify your programming work. In order to avoid surface blemishes during approach or departure from the contour, movement must be seamless—that is, tangential.

You simply specify the starting point or end point of the contour and the approach or departure radius of the tool. The control handles the rest.

The TNC7 basic can foresee a contour with radius compensation by up to 99 blocks, thus taking back-cutting into account and avoiding contour gouging. This could be the case, for example, when roughing a contour with a large tool.

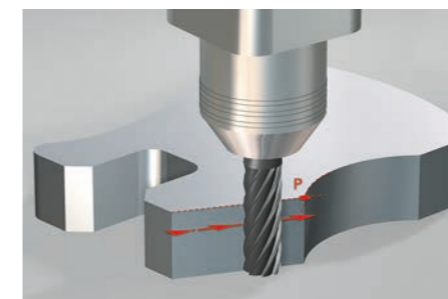

L Straight line defined by its end point

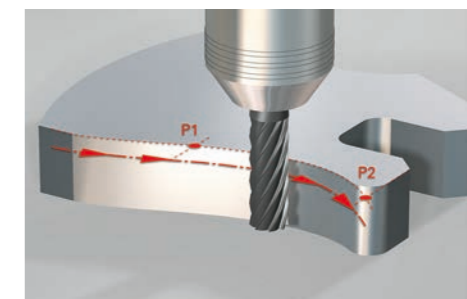

CT Circular path with smooth (tangential) connection with the preceding contour element, defined by end point

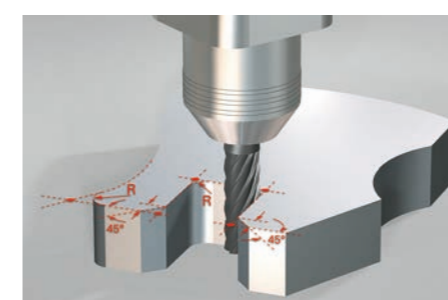

RND Corner rounding: circular path with a seamless (tangential) transition, defined by its radius and corner point

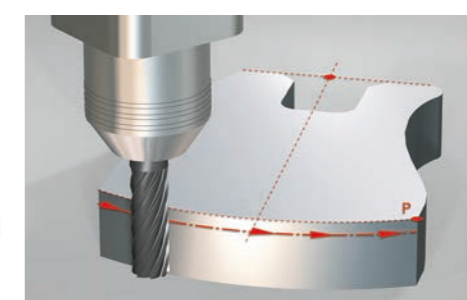

CC Circular path defined by its center, end point, and rotational direction

CHF Chamfer defined by the corner point and chamfer length

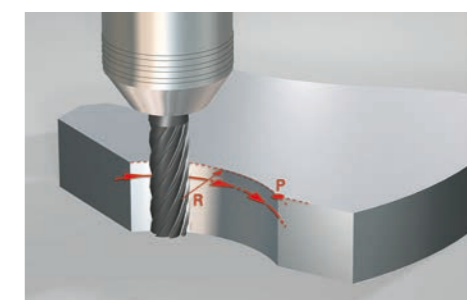

CR Circular path defined by its radius, end point, and rotational direction

Not all workpieces are properly dimensioned in accordance with the ISO standard. That is why the TNC7 basic supplements the familiar Klartext programming with smart functions. With the graphical programming feature, you draw contours directly on the touchscreen. Other detailed information about contour elements is specified in context-sensitive dialogs. The TNC7 basic then converts your drawing into Klartext and saves it, or you can save the contour as its own program (.tncdrw). Existing programs can be modified very easily.

Even already programmed contours can be edited using this graphic support. To do so, simply select the contour in the Klartext editor, and then drag and drop it to the contour editor for modification. Once editing is finished, the final result is applied to the Klartext program.

The graphical programming function makes it possible to quickly and easily program contours that are not properly dimensioned for NC machining. Even FK programs from older TNC controls are very easily modified with graphical programming. The TNC7 basic then generates a finished Klartext contour program.

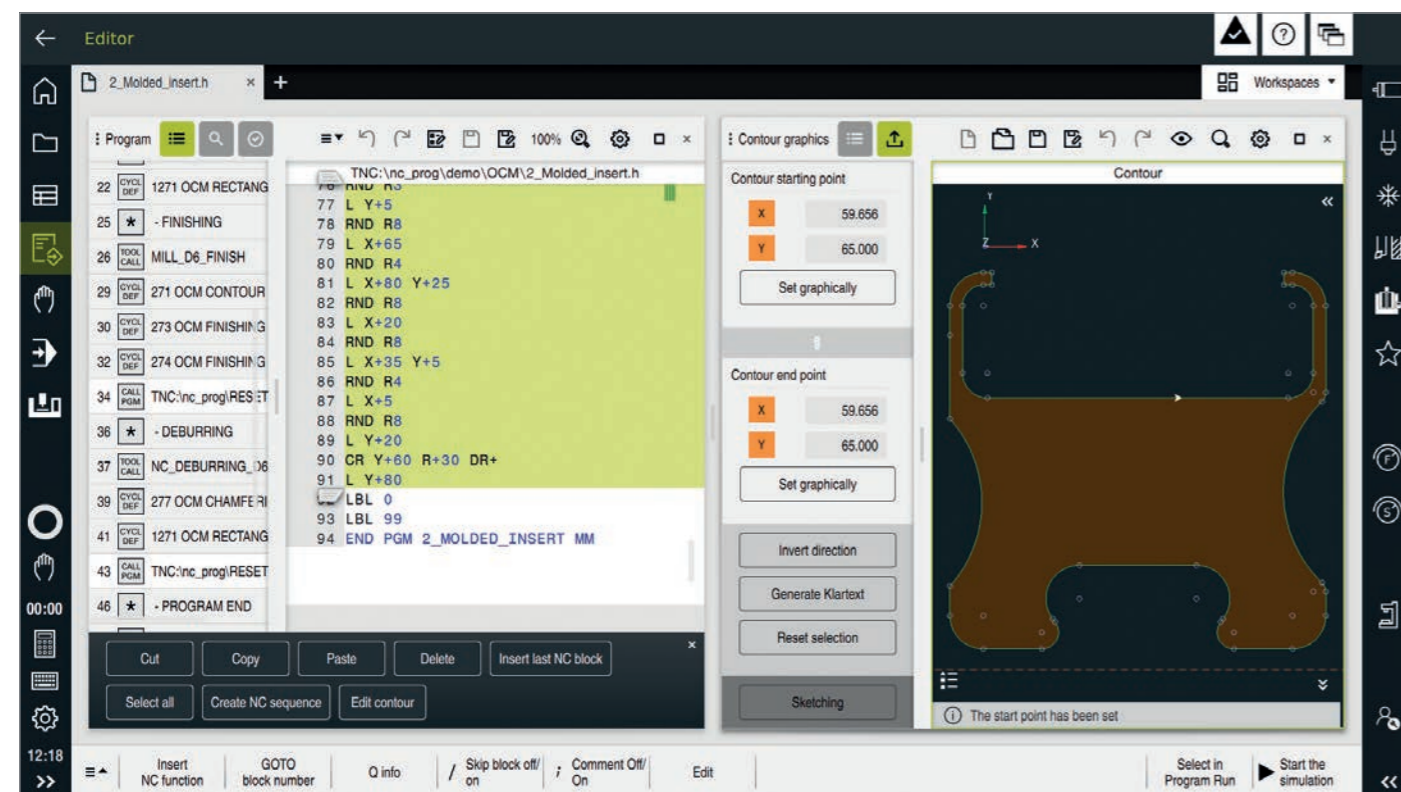

Extensive machining cycles for milling and drilling

The TNC7 basic offers you a package covering a broad range of cycles, so you'll surely find the right one for each task. The cycles are divided into groups based on the machining technologies and strategies, ensuring that you always maintain a clear overview. You program them using form-based conversational guidance, assisted by graphics that clearly illustrate all required input parameters.

Standard cycles

In addition to drilling and tapping cycles (with or without a floating tap holder), a variety of selectable cycles are available:

- Thread milling
- Reaming
- Engraving
- Boring
- Hole patterns
- Milling cycles for face milling a flat surface
- Roughing and finishing of pockets, slots, and studs

Programming machining patterns with ease and flexibility

Positions to be machined are often arranged in patterns on the workpiece. The TNC7 basic's graphical support helps you program a wide range of machining patterns with ease and exceptional flexibility. You can define as many point patterns as desired with various numbers of points. During machining, you can then have all of the points executed as a unit, or each point individually.

Fast and easy programming of a scannable Data Matrix code

Cycle 224 (Data Matrix code pattern) lets you convert any text into a Data Matrix code and machine it onto your workpiece as a point pattern using, say, drilling operations. The Data Matrix code can be decoded with common scanning devices. Serial numbers and production data can thus be permanently machined onto the part. All you need to do after defining a machining cycle is enter the text (up to 255 characters) into the cycle and specify the size and position of the drilling pattern. The control automatically calculates the Data Matrix code and performs the machining work on its own.

Cycles for complex contours

Of great help in roughing pockets with any contour are the control's SL cycles (SL = Subcontour List) and OCM cycles (a part of the Optimized Contour Milling software option). These functions refer to machining cycles for pilot drilling, roughing, and finishing in which the contour or subcontours are defined in subprograms. As a result, a single contour description can be used for various operations with different tools.

Up to twelve subcontours can be superimposed for the machining operation.

The control automatically calculates the resulting contour and the tool paths for roughing or clearing the surfaces.

Subcontours can be pockets or islands. Multiple pockets are combined to form a single pocket, with the tool bypassing any islands. You can also program void areas that are excluded from machining. This significantly reduces machining times for cast parts or pre-machined workpieces.

During roughing, a finishing allowance on the wall and floor surfaces is also taken into account by the TNC7 basic. When roughing with different tools, the control identifies residual material to be removed by smaller tools. A separate cycle is used for finishing to the final dimensions.

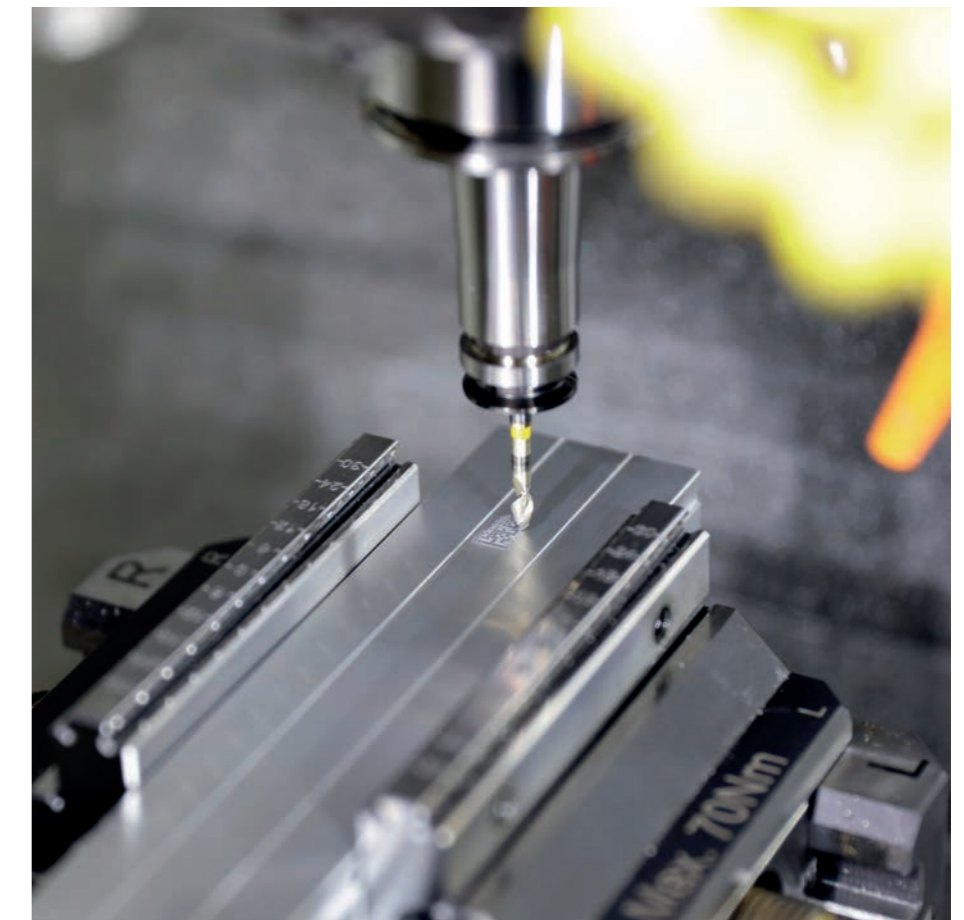

Reusing programmed contour elements

Coordinate transformations

If you need a pre-programmed contour at different locations and in different sizes on the workpiece, then the TNC7 basic offers you a convenient solution in the form of coordinate transformations.

With coordinate transformation you can, for example, rotate or mirror the coordinate system, or shift the datum. With a scaling factor you can enlarge or reduce contours to respect shrinkage or oversizes.

Program-section repeats and subprograms

Many machining operations repeat themselves either on the same workpiece or on different workpieces. Once you have programmed a detail, there is no need to program it again. With its subprogram technology, the TNC can save you a great deal of programming time.

In program-section repeats, you can label a section of the program, and the TNC will repeat this section as many times as required.

You can mark a program section as a subprogram and then call it at any point in the program and as often as you want.

With the program call function, you can even use a completely separate program at any location in your current program. This allows you to leverage already programmed and frequently required working steps or contours.

Of course, you can also combine these programming techniques as often as desired.

Graphical support in any scenario

Simulation

For added certainty prior to machining, the TNC7 basic can simulate and render the machining of the workpiece at high resolution. The TNC7 basic offers optimal assistance through virtual simulation of the machined part and work envelope. The machining operation can be visualized in various manners:

- Plan view at different levels of depth
- Various projections
- 3D view

Touch gestures can naturally be used throughout the simulation. This means that rotating or moving the simulation graphic, or zooming in and out, is particularly easy. The Simulation workspace is available directly within the Editor operating mode. This means you don't need to switch between operating modes when testing and editing an NC program.

You select the type and quality of the image, and a powerful zoom function lets you see even the tiniest details. During the machining simulation, the TNC7 basic can also display all of the machine components defined by the machine manufacturer, in addition to the workpiece and tool. That way you already know in advance in which areas it will be tight or the traverse paths will not suffice—an enormous advantage when working with tilting axes. You should also use the simulation to very thoroughly inspect programs created externally for irregularities before machining, for example in order to detect undesirable traces of the machining process on the workpiece.

Display functions

In the simulation, the TNC7 basic displays the calculated machining time in hours, minutes and seconds. The control does not dwell during the simulation, but adds the dwell times to the program run time. Also, all surfaces of the simulation graphic are color-coded based on the tool that was used. That way you see at a glance which area was machined with which tool. Thanks to the high degree of flexibility when arranging the display elements, the simulation can easily be individually customized with all necessary information.

The TNC7 basic also features a cutout view that lets you move the cutting edge along the selected plane, so you can look inside the workpiece in order to evaluate internal machining operations, for example.

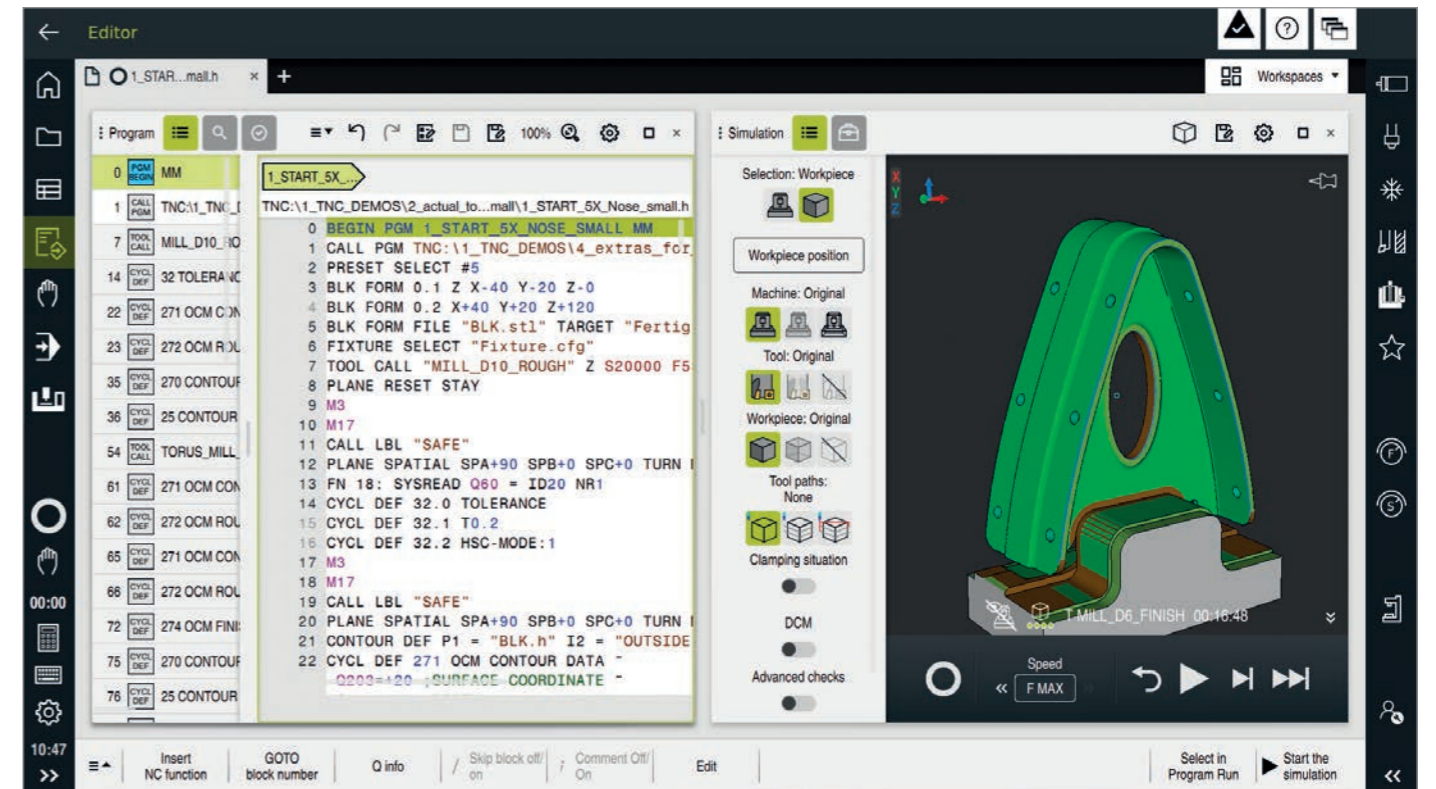

Rapid availability of all information

STL import

The importing of STL files enables the convenient incorporation of complex workpiece blanks and finished parts, such as 3D models from CAM systems. Furthermore, a simulated workpiece can be saved as an STL file and then integrated into another program as a workpiece blank.

Model comparison

The TNC7 basic has a feature for comparing the workpiece blank and the finished part. The colors in the model indicate where residual material still remains, or even places where too much material was removed. There is also a measuring function, where you place the cursor anywhere you want. Along with the depth and position, the control then also displays the tool used there and the corresponding NC block.

Program run

Direct observation of the real workpiece is usually impossible due to coolant and the safety enclosure. The simulation synchronously traces the machining operations while the program is running. That way you can always see the current machining status of the workpiece as well as the positions of the collision objects. During machining, you can switch between various operating modes at any time in order to create programs, for example.

User administration

The user administration feature of the TNC7 basic lets you define various roles and access rights for users, ensuring that each user can act only within his assigned rights. This helps prevent the unintentional or unauthorized deletion of files and system file content. Many functions are also available only with the corresponding permissions. Consequently, the user administration feature not only provides greater data security but also increases machine operating safety.

Do you have questions about a programming step, but your User's Manual is not at hand? No problem: the TNC7 basic control features TNCguide, a convenient help system that displays the user documentation in a separate window. You can activate TNCguide by pressing the HELP key on the TNC keyboard, by using the question mark, or by opening the Help workspace.

In the factory default setting, the control offers the integrated product aid TNCguide in German and English language versions. You can download the documentation in other languages free of charge from the HEIDENHAIN website and save it to the appropriate language directory.

TNCguide generally displays the information instantaneously and in the correct context (context-sensitive help), immediately giving you the information you currently need. This function is particularly helpful for cycles, providing a detailed explanation of the parameters.

The documentation includes NC examples for the various functions. Use the copy function to copy these NC examples from the documentation directly to your NC program.

The TNC7 basic offers training videos for learning about the control's user interface, functions and operating possibilities. These

brief instructional videos also provide you with useful terminology. Knowing the correct terms makes it easier and quicker to find the information you are looking for in the User's Manuals or in the integrated TNCguide.

The following User's Manuals are collected in a central help system:

- Setup and Program Run
- Programming and Testing
- Machining Cycles
- Measuring Cycles for Workpieces and Tools

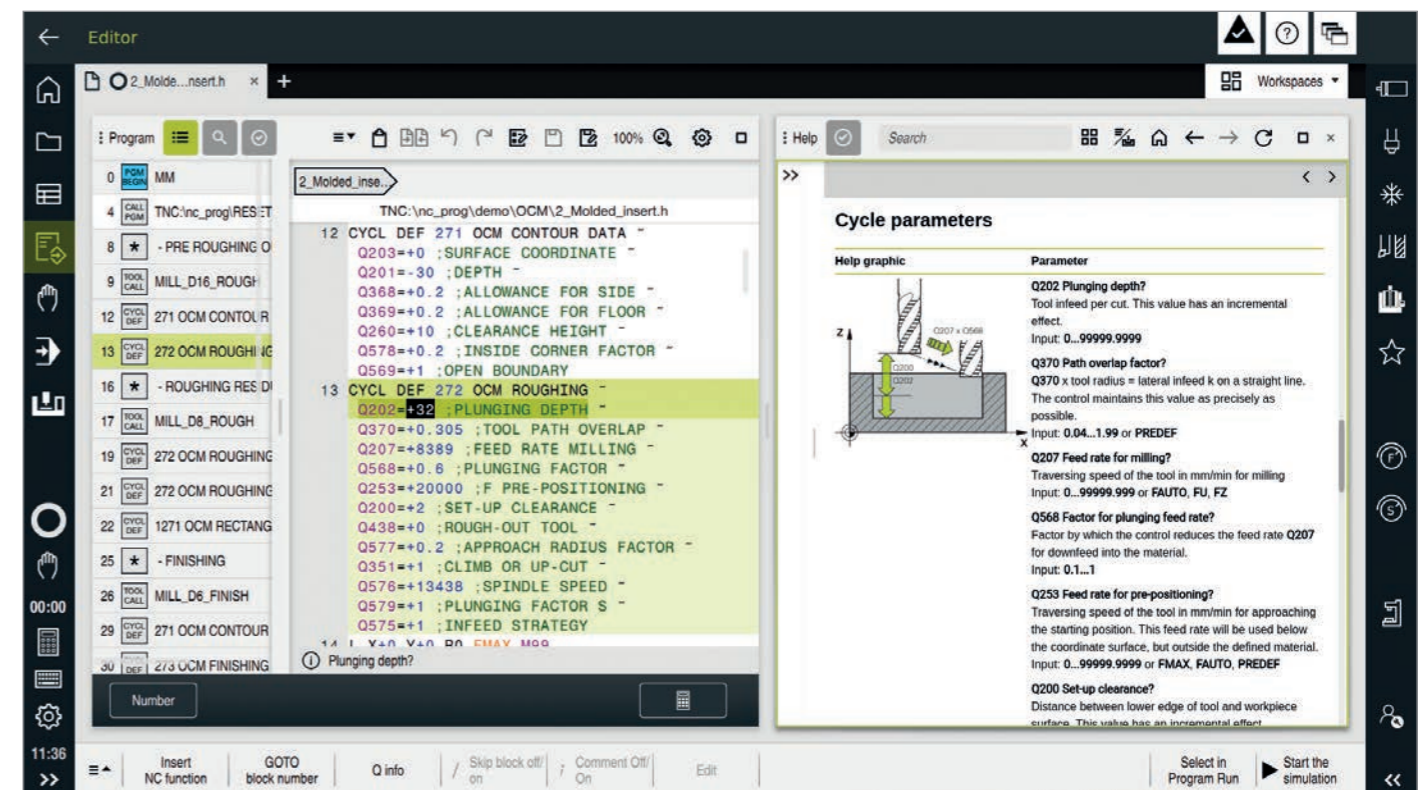
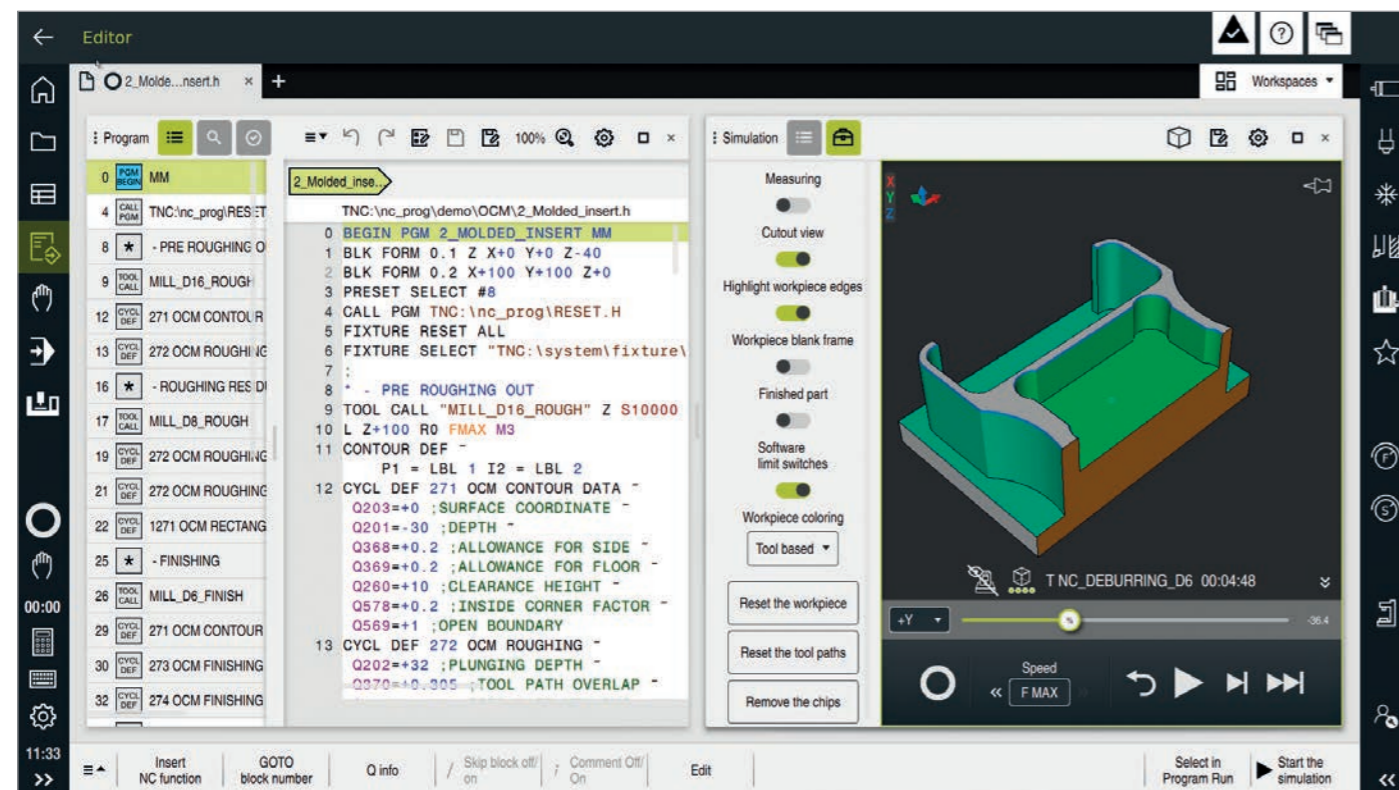

dynamic + efficiency

With the concept of Dynamic Efficiency, HEIDENHAIN offers innovative TNC functions that help the user to make heavy machining and roughing more efficient while also enhancing its process reliability. These software functions not only assist the user but also make the manufacturing process itself faster, more stable, and more predictable—in short, more efficient. Dynamic Efficiency permits higher removal rates and therefore increases productivity without making the user resort to special tools. At the same time, it prevents tool overloading and premature cutter wear. Dynamic Efficiency makes your manufacturing overall more economical while increasing process reliability.

Dynamic Efficiency encompasses four software functions:

- **Active Chatter Control (ACC)** reduces chatter tendencies and thus permits higher feed rates and greater infeeds.
- **Adaptive Feed Control (AFC)** controls the feed rate depending on the machining situation.
- **Trochoidal milling** is a function for tool- and machine-friendly roughing of slots and pockets.
- **Optimized Contour Milling (OCM)** allows pockets and islands of any shape to be machined with low tool wear using the highly efficient trochoidal milling method.

Individually, each of these solutions delivers key improvements to the machining process. But in combination, these TNC functions bring out the full potential of the machine and tool while reducing the mechanical load. They are also of great value under changing machining conditions, such as during interrupted cuts, various plunging processes, or simple roughing operations. In practice, the removal rate can be increased by 20 to 25 percent.



Roughing operations (power milling) give rise to strong milling forces. Depending on the rotational speed of the tool, the resonances in the machine tool, and the material removal rate during milling, the tool may begin to “chatter.” Chatter puts the machine under heavy strain and causes blemishes on the workpiece surface. Tool wear is also accelerated and less evenly distributed. In extreme cases, the tool may even break.

In order to reduce a machine’s susceptibility to chatter, HEIDENHAIN offers an effective regulating function known as Active Chatter Control (ACC). This option is particularly beneficial during heavy machining:

- Improved cutting performance
- Higher removal rates (up to 25% and more)
- Lower forces on the tool, with increased tool life
- Less strain on the machine

dynamic + efficiency



Heavy machining without ACC

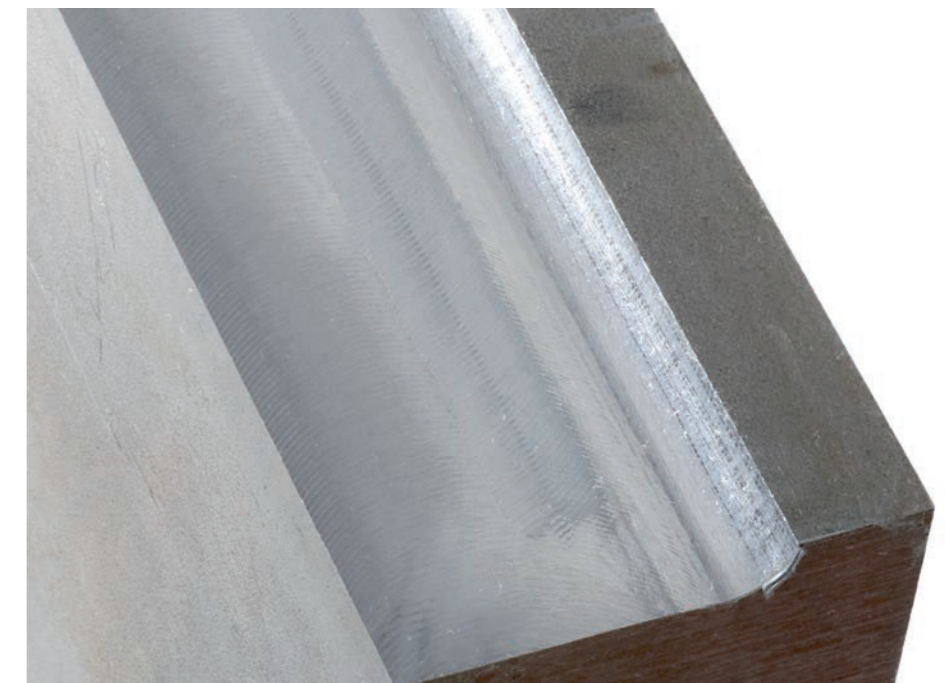

Heavy machining with ACC



HEIDENHAIN controls have always allowed the user to enter the feed rate for each block or cycle and also manually adjust the feed rate to the actual machining situation using an override potentiometer. But this approach relies on the experience of the user and requires him to be at the machine.

Adaptive Feed Control (AFC) automatically regulates the feed rate of the TNC, taking into consideration the given spindle power and other process data. The TNC first records the maximum spindle power during a teach-in cut. Prior to machining, you define the limits (in a table) within which the TNC is allowed to influence the feed rate in "control" mode. You can flexibly choose among various overload reactions that have been defined by the machine manufacturer.

Adaptive Feed Control offers a series of benefits:

Process reliability

Roughing at high material removal rates involves strong cutting forces, which in practice can cause tool defects. If the user is unable to react quickly, perhaps because he is responsible for multiple machines or because the shift is unattended, then significant secondary damage and cost may be incurred:

- Costly rework on the workpiece
- Irreparable workpiece damage
- Damage to the tool holder
- Machine downtime due to spindle damage

Continuous monitoring detects any increase in spindle power due to tool wear or defective inserts, and a replacement tool can be automatically inserted.* In this manner, AFC prevents potential secondary damage due to tool wear while increasing process reliability.

Reduced machining time

AFC regulates the feed rate of the TNC based on the given spindle power. In machining areas requiring less material removal, the feed rate is appropriately increased. This can significantly reduce the machining time.

Gentler on the machine

When the maximum teach-in power is exceeded, the feed rate is reduced down to the reference spindle power. As a result, the machine undergoes less strain, and the main spindle is protected from overloading.

* The control must be adapted for these functions by the machine manufacturer.

The ability to machine any slot at high efficiency from start to finish is the key benefit of trochoidal milling. In this cycle, roughing is performed with circular movements, onto which a forward linear movement is superimposed. This procedure is referred to as trochoidal milling. It is used particularly for milling high-strength or hardened materials, where the high loads placed on the tool and machine usually only permit small infeeds.

Thanks to the special cutting motion used in trochoidal milling, however, there are no added wear-inducing influences on the tool, and higher infeeds are possible. The entire length of the cutting edge of end mills can be used. You thereby attain a higher material removal rate per tooth. Circular-motion plunging into the material exerts less radial force on the tool. This reduces the mechanical load on the machine and prevents vibration.

The slot to be machined is described in a contour subprogram as a contour train. You define the dimensions of the slot and the cutting data in a separate cycle. Any residual material can then be easily removed with a subsequent finishing cut.

The main benefits are as follows:

- Contact over entire cutter length
- Higher removal rates
- Less strain on the machine
- Less vibration
- Integrated finishing of the side wall
- Superior chip removal

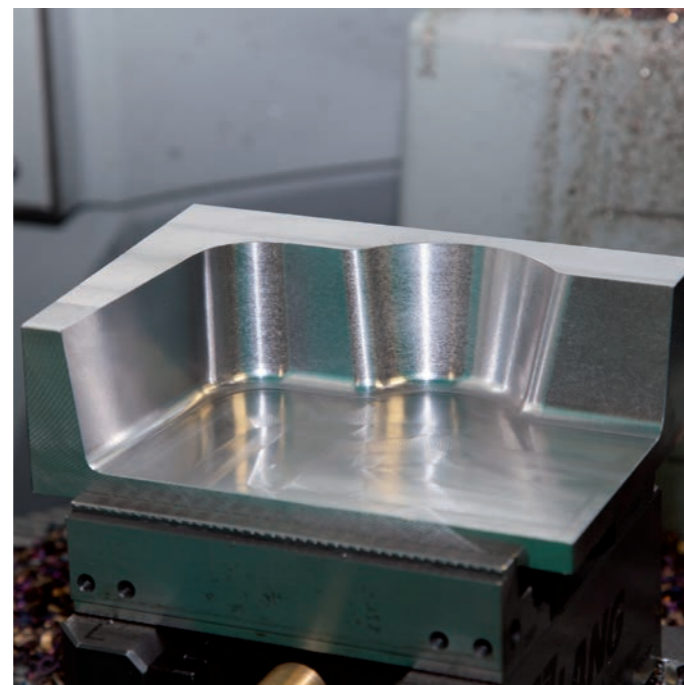
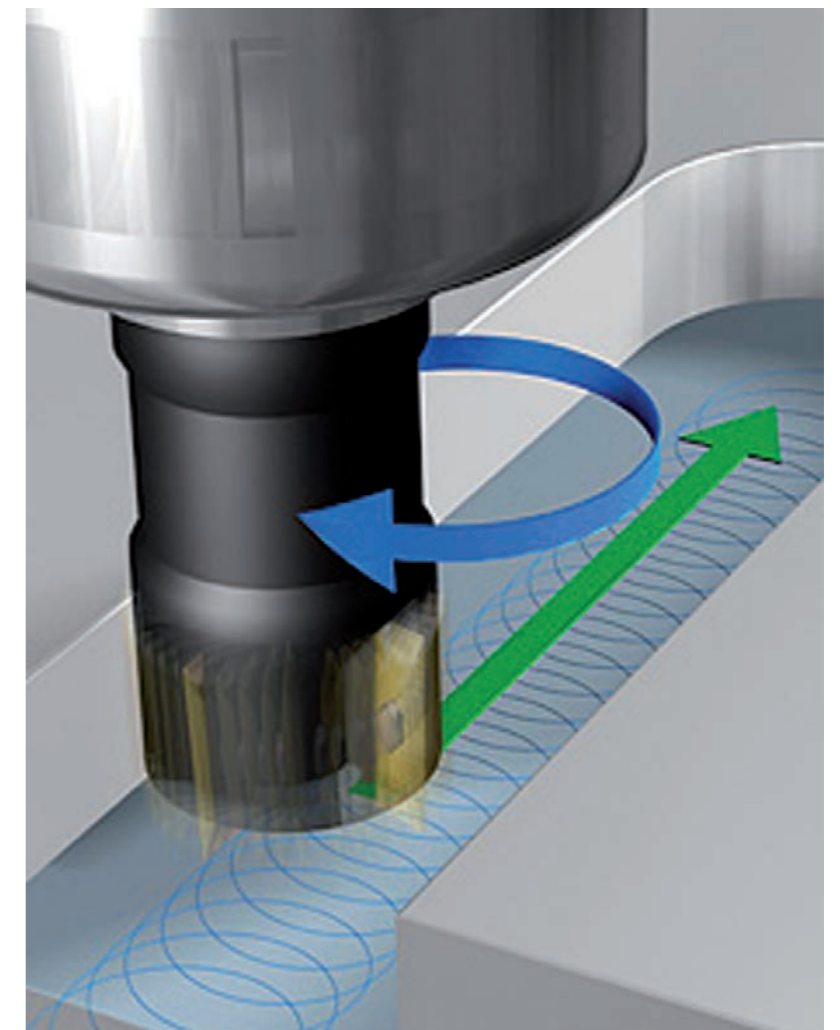

Workpiece with secondary damage resulting from a broken indexable insert

Fully machined workpiece protected by AFC

dynamic + efficiency

Efficient machining strategies are a key basis for economical NC manufacturing. Roughing processes, in particular, offer great potential for optimization because they usually make up a sizable portion of the total machining time.

Process reliability and maximum removal rates require optimal adaptation of the cutting data to the characteristics of the tool and workpiece material. Optimized Contour Milling (OCM) gives you a cutting data calculator that draws on a comprehensive integral materials database. You can adapt the automatically calculated cutting values with regard to the mechanical and thermal load on the tool. Tool service life can be managed with process reliability even at the highest possible removal rates.

With OCM, you can rough out any pocket and island with high process reliability and lower tool wear thanks to highly consistent process conditions. Simply program the contour as usual in Klartext, or leverage the convenient CAD Import function. The control then automatically calculates the complex movements required for maintaining consistent process conditions. OCM takes void areas into account, which significantly reduces machining times (with NC software version 16 or later).

Advantages of OCM over conventional machining:

- Reduced thermal load on the tool
- Superior chip removal
- Consistent tool contact conditions (higher cutting parameters and higher material removal rate)

OCM is an effective, reliable, and convenient way to improve your throughput

- Create programs on the shop floor for any pocket or island
- Significantly higher machining speed
- Considerable reduction in tool wear
- More chips in less time

The OCM software option provides practical cycles for roughing, side-wall finishing, and floor finishing.

OCM also permits chamfering and deburring of contours. With this capability, only those areas that can be machined without collisions due to the tool geometry are machined. In order to machine

standard shapes, OCM offers various figures that are then used as a pocket, island, or boundary for face milling in conjunction with other OCM cycles.

In the following machining example, both the machining time and the tool wear were reduced by a factor of three.

Conventional machining
<i>S5000, F1200, a_p: 5.5 mm</i>
<i>Overlap factor: 5 mm</i>
<i>Machining time: 21 min 35 s</i>

Tool: VHM end mill (Ø 10 mm)
Workpiece material: 1.4104

Machining with OCM
<i>S8000, F4800, a_p: 22 mm</i>
<i>Overlap factor: 1.4 mm</i>
<i>Machining time: 6 min 59 s</i>

Tool: VHM end mill (Ø 10 mm)
Workpiece material: 1.4104

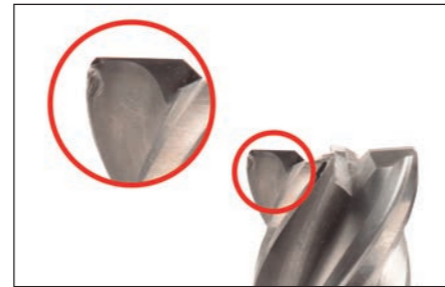

Machining without OCM: Tool after two parts

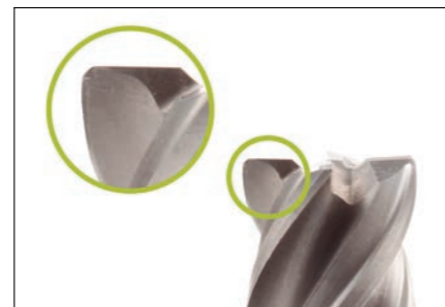

Machining with OCM: Tool after six parts

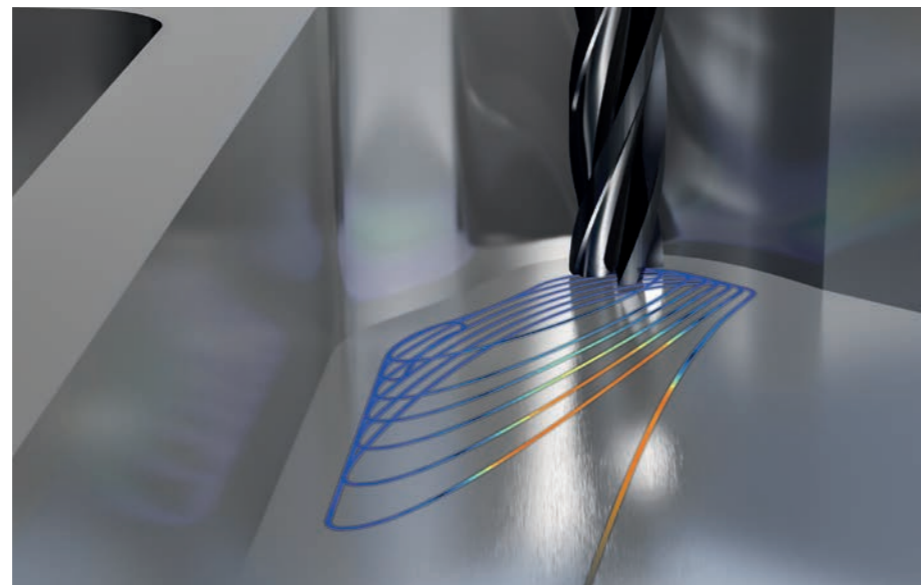

CAD Viewer

With the standardly available CAD Viewer software, you can open 3D CAD models and drawings directly on the TNC7 basic. Various view options as well as rotation and zoom capabilities allow for a detailed visual inspection and analysis of your CAD data. You can also use the viewer to ascertain position values from a 3D model. You simply select an arbitrary reference point in your drawing and select the desired contour elements. CAD Viewer then displays the coordinates of the elements in a window. CAD Viewer can depict the following file formats:

- STEP files (.STP and .STEP)
- IGES files (.IGS and .IGES)
- DXF files (.DXF)
- STL files (.STL)

CAD Import (option)

Why program complex contours if you already have the drawing as a DXF, STEP, STL or IGES file? After all, you have the ability to extract contours or machining positions from these types of CAD files. This not only saves time otherwise spent on programming and testing, but you can also be sure that the finished contour is exactly in accordance with the design engineer's specifications.

Extracting machining information directly from CAD data offers additional possibilities, particularly for the creation of NC programs with a tilted machining plane. You can also define the preset with a 3D basic rotation of the 3D model and set a datum with the appropriate 3D rotation in the desired working plane.

You can easily save the working plane to the clipboard and transfer it to the NC program with the appropriate transformation and the associated PLANE command. In the defined working plane, you can extract contours and machining positions, and apply them to the NC program.

Selecting contours is very convenient: Start by selecting any element. Once you select a second element, the TNC detects your desired machining direction and initiates automatic contour detection. In doing so, the TNC automatically selects all clearly identifiable contour elements until the contour closes or branches out. In this manner, you can define extensive contours with just a few steps. You can then easily copy the selected contour via the clipboard to an existing Klartext program.



You can also select machining positions and save them as point files, especially in order to apply hole positions or starting points for pocket machining. This can be done very easily by selecting the desired area. In a pop-up window with a filter function, the TNC displays all of the hole diameters within the area you have selected. To select the desired hole diameters and restrict the number of hole positions, simply select the corresponding filter symbol to change the filter limits. A zoom function and various setting possibilities complement the functionality of the CAD import.

It is also possible to define the contour program's resolution for using it in older TNC controls. You can also define a transition tolerance if the contour elements are not completely connected.

- The following positions can be defined as presets:
- The beginning, end, or mid-point of a line
 - The beginning, end, or center point of a circular arc
 - Quadrant transitions or center point of a circle
 - Intersection of two lines, including in their extension
 - Intersection of a line and a circular arc
 - Intersection of a line and a circle

If multiple intersections between two elements are possible (e.g., between a straight line and a circle), then you can select the correct intersection with a tap of your finger

Generating STL files (option)

The CAD Model Optimizer software option makes it possible to generate STL files from 3D models. The TNC basic covers the 3D model displayed in CAD Viewer with a mesh of triangles. This simplifies the original model and removes errors, such as small holes in a solid or self-intersections of a surface. The TNC7 basic then generates an STL file that you can use for various functions of the control. For example, you can easily repair faulty files of fixtures or tool holders.

Having a smooth exchange of knowledge is crucial for the success of a company. In order for knowledge to be transferred rapidly and without loss, e-mail communication capability is just as important as the continuous availability of electronic production documents or the transfer of data to ERP and production-activity control systems. Tool and raw material inventories, tool data, workholding drawings, CAD data, NC programs and inspection instructions must all be available to machine users during all shifts. Cost-effective manufacturing therefore requires an efficient process chain and a networked control.

With its Connected Machining package of functions, the TNC basic control integrates itself flexibly into your process chain and helps you optimize the transfer of knowledge within your company. So let your shop benefit from all of the information available in your company. Connected Machining makes fully digital job management possible in networked manufacturing. You thus benefit from the following:

- Ease of data usage
- Time-saving procedures
- Transparent processes

The networked TNC7 basic

Integrate the TNC7 basic with the functions of Connected Machining into your corporate network and, via the control, connect the shop floor to PCs, programming stations, and other data storage media in these areas of the company:

- Design
- Programming
- Simulation
- Production planning
- Production

Even the standard version of the TNC7 basic is equipped with two Gigabit Ethernet ports of the latest generation. The TNC7 basic uses the TCP/IP protocol to communicate with NFS servers and Windows networks without needing additional software. The fast data transfer of up to 1000 Mbit/s ensures very short transmission times. The TNC basic thus offers the optimal technological foundation for Connected Machining, the networking of the control in the shop with all production-related areas in your company.

Standard range of functions

For you to be able to use the data that you transfer to the TNC7 basic over a network, the TNC7 basic offers attractive applications, even as part of its standard range of functions. The PDF viewer or Mozilla Firefox web browser enable the simplest form of Connected Machining: access to production process data directly on the control. In this case, operating web-based documentation systems or ERP systems is just as feasible as accessing your e-mail inbox. For example, the following file formats can also be opened directly on the TNC7 basic:

- Text and PDF files
- Graphic files with the extensions .gif, .bmp, .jpg or .png
- Spreadsheet files with the extensions .xls, .xlsx, .odv or .csv
- html files: .htm, .html, .chm
- and several more

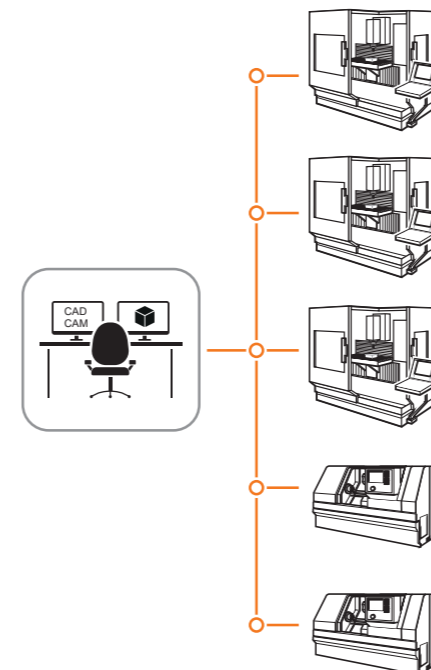
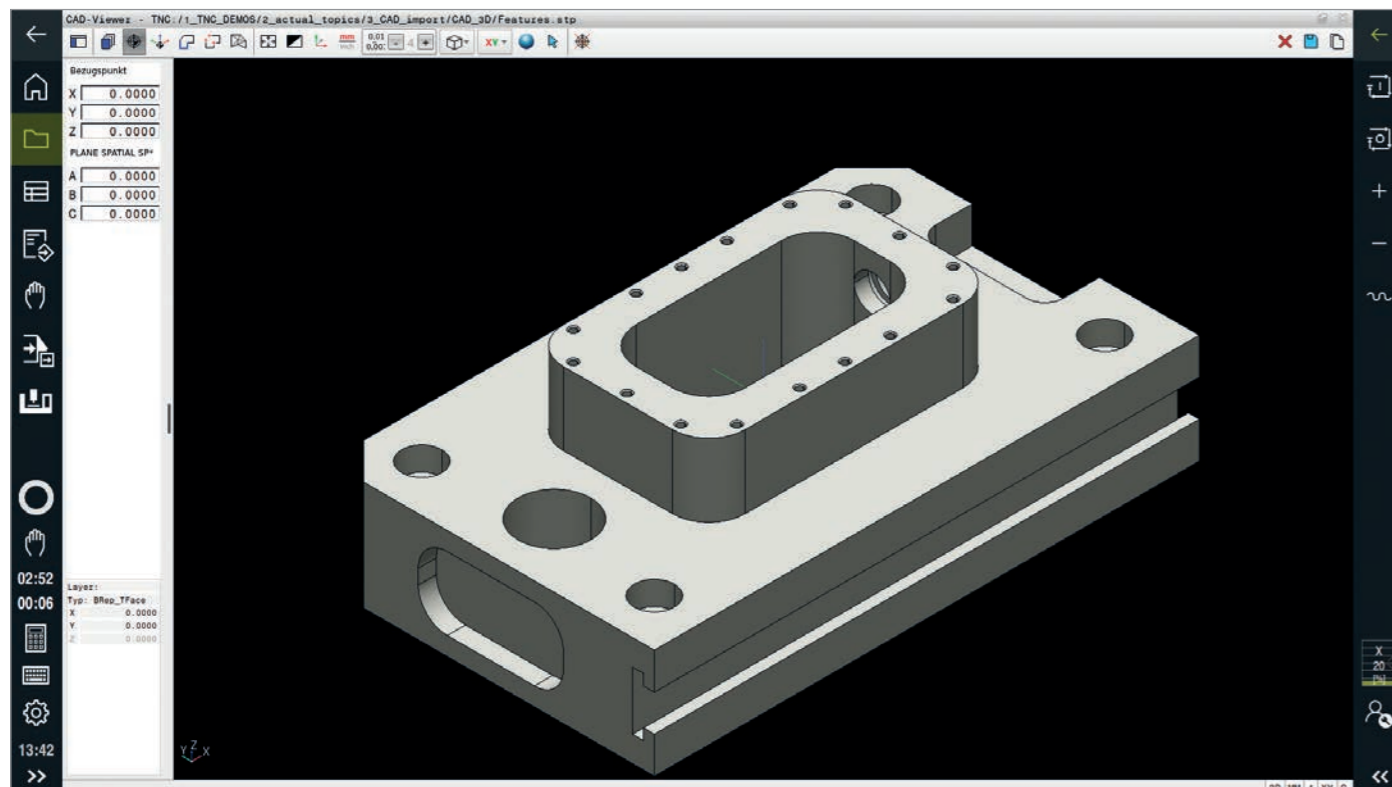

Programming station

Your workstation

connected + machining

Data transmission

Another solution for full digital job management with Connected Machining is the free-of-charge TNCremo PC software. With it, you can transfer remotely stored part programs and pallet tables in both directions over the Ethernet.

With the powerful TNCremoPlus PC software, you can also transfer the screen contents from the control to your PC using the live-screen function.

Job-related data (option)

With the Remote Desktop Manager software option, you can operate a Windows PC from the TNC basic. On the control, you gain direct access to IT systems within the process chain and make your machine setup processes significantly more efficient by reducing inconvenient legwork between the machine and the office. Technical drawings, CAD data, NC programs, tool data, work instructions, parts lists, and warehouse information are digitally available at the machine. E-mails can be sent and received with ease. With a simple keystroke on the machine operating panel, you can switch between the control screen and the screen of the Windows PC. This PC can be a computer in the local network or an industrial PC (IPC) in the machine's electrical cabinet.

Detailed data for the optimal organization of the production process

HEIDENHAIN DNC enables the connection of existing machine tools to Windows-based industrial applications, meaning that even older TNC controls, like the TNC 426/430 or the iTNC 530, can be connected to modern inventory management systems and production-activity control systems. Use RemoTools SDK to connect your applications to TNC controls, or purchase an application that is DNC-compatible.

Appropriate monitoring and controlling of applications

Efficient and secure digital communication in a machine-tool context requires standardized components, application-relevant information models and adherence to current IT security guidelines. OPC UA NC Server offers an interface based on OPC UA for HEIDENHAIN controls. This internationally standardized and widespread communication technology makes it fast and easy to connect machines to your production IT.

You also save time when integrating new functions because the application-oriented presentation of information reduces programming and configuration effort.

- *State-of-the-art IT security:* Authentication, authorization and cryptography
- *Uncomplicated:* Guided connection configuration
- *Application-oriented:* Tailored to the demands of modern industrial applications
- *Standardized:* OPC UA is the communication technology recommended for Industry 4.0
- *Freedom of choice:* Open selection of operating system and toolkit
- *Virtual testing environment:* Free HEIDENHAIN programming station
- *Expandable by the machine manufacturer:* The machine manufacturer can also enhance the OPC UA NC Server, giving you access to additional sensors, machine subsystems, or values from PLC programs.

What does the programming station look like?

The programming station is an application for PCs with Windows operating systems. The software offers you the same TNC user interface and graphic support as the control of your machine. Depending on the version of the programming station, there are several types of possibilities for using it.

Demo version of the programming station

A demo version of the programming station is available for testing (for free download from www.heidenhain.com). It contains all functions of the TNC, and permits short programs to be saved. The demo version is programmed with the virtual keyboard or PC keyboard. A PDF of the key assignment for the PC keyboard is included in the download.

Programming station with TNC operating panel

A separate TNC machine operating panel is connected to the PC via the USB port. You then create your programs as always, on the same keyboard as on the machine. The keyboard also includes the soft keys, which are otherwise integrated in the display unit. It has a PC keyboard for convenient and efficient entry of file names and comments. Overlays for better soft-key association and self-adhesive strain relief for the USB cable are included in delivery.

Programming station with virtual keyboard

You can also work without the TNC operating panel: this programming station is operated with a virtual keyboard instead. It is displayed together with the TNC control panel on the PC screen, and features the most important dialog initiation keys of the TNC. A hard-lock key (dongle) is included.

The programming station with virtual keyboard is available in the following versions:

- Single station license
- Network license for 1, 14 or 20 stations. The stations must be interconnected with each other, because the software dongle is connected to only one PC. The network license is therefore especially useful for training rooms.

Programming station keyboard for the TNC7 basic

The programming station keyboard is based on the TNC7 basic control panel and, owing to its compact design, is excellently suited for use at the office workstation or for training purposes. With the keyboard, you can operate the programming station very ergonomically and, thanks to the long-travel key mechanism, particularly comfortably.

The TNC7 basic programming station keyboard:

- Hardware in the modern TNC7 design
- Compact design for use at the office workstation
- Installation slot for USB dongle on the bottom
- Strain relief for USB cable integrated in the housing
- Newly designed keyboard with an improved feel
- Dirt-repelling, anodized surface of the keyboard

The TNC7 basic programming station keyboard can be combined as desired with the different programming station variants (dongle versions). Your USB dongle is safely protected in the installation slot in the bottom of the housing.

The operating design of the TNC7 basic is fully touch-optimized. Just like the TNC7 basic itself, the new programming station keyboard has no separate soft keys. You select the soft keys either with the mouse or directly by touching the screen.



Further information:

Comprehensive descriptions of the programming station and a free demo version are available on the Internet at www.heidenhain.com/programming-stations

Workpiece measurement

Setup, preset setting, and measuring with touch trigger probes

The workpiece touch probes* from HEIDENHAIN help reduce costs in the shop and for serial production. Setup, measurement, and control functions can be automatically executed in conjunction with the touch probe cycles of the TNC7 basic.

Upon contact with the workpiece surface, the stylus of a TS touch trigger probe is deflected. At that moment the TS generates a trigger signal that, depending on the model, is transmitted to the control either by cable or by radio or infrared transmission.

The touch probes are inserted directly into the machine tool spindle and can be equipped with various taper shanks depending on the machine. The ball tips, which are made of ruby, are available in different diameters with various stylus lengths.

* The control must be adapted for these functions by the machine manufacturer.



TS 460

Further information:

You can find detailed descriptions of workpiece touch probes on the Internet at www.heidenhain.com or in the *Touch Probes for Machine Tools* brochure.

Cable-bound touch probes

For machines requiring manual tool changes, as well as for grinding machines and lathes: *TS 260*

- Axial or radial cable connection
- High scanning accuracy

Wireless touch probes

For machines with an automatic tool changer:

TS 460

- Standard touch probe for radio and infrared transmission
- Compact dimensions
- Energy-saving mode
- Optional collision protection
- Thermal decoupling

TS 642

- Activation via switch in taper shank
- Infrared transmission

TS 760

- High scanning accuracy
- High reproducibility
- Low probing forces
- Radio and infrared transmission

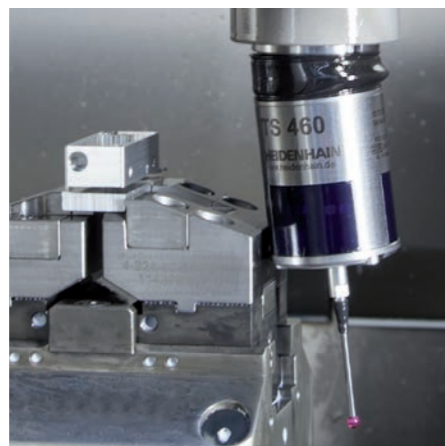

TS 460 with collision protection

Transceiver

Radio or infrared transmission is established between the TS or TT touch probe and the SE transceiver:

SE 660

- For radio or infrared transmission (hybrid technology)
- Same SE for TS 460 and TT 460

SE 661

- For radio or infrared transmission (hybrid technology)
- Same SE for TS 460 and TT 460
- EnDat functionality for transmission of the switching state, diagnostics, and additional information



SE 660

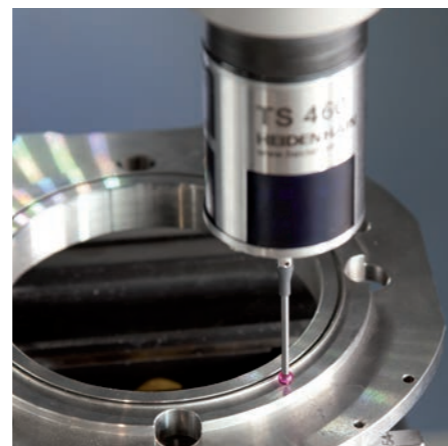

Tool measurement

Measuring length, radius, and wear inside the machine

A key factor in obtaining consistently high production quality is, of course, the tool. This requires exact measurement of the tool dimensions and periodic inspection of the tool for breakage, wear and tooth shape. For tool measurement, HEIDENHAIN offers the TT triggering tool touch probes.

These touch probes are installed directly within the machine's workspace, where they enable tool measurement either before machining or during interruptions.

The TT tool touch probes measure the tool length and radius. During probing of the rotating or stationary tool, such as for individual tooth measurement, the contact plate is deflected and a trigger signal is transmitted directly to the TNC7 basic.

The TT 160 uses cable-bound signal transmission, whereas the TT 460 sends its signals via radio or infrared transmission. It is thus particularly well suited for use on rotary/tilting tables.

To prevent limiting the machining space and to avoid collisions, the touch probe must occasionally be removed from the machine. The touch probe's new magnetic base features three contact points and a setting screw. As a result, the touch probe requires calibration only during initial installation and can then be re-installed and removed with a quick hand movement.

Here are the benefits in a nutshell:

- Fast re-installation without recalibration
- Low-profile base
- Same accuracy as permanent installation



TT 460

Further information:

You can find detailed descriptions of tool touch probes on the Internet at www.heidenhain.com or in the *Touch Probes for Machine Tools* brochure.



Efficient running-in of NC programs

OC 310 override controller

Running a new NC program for a workpiece requires much time and concentration. This procedure becomes much easier and more reliable with the following enhancements:

- Conditional stops using breakpoints
- OC 310 override controller



Conditional stops using breakpoints

When running-in a new program, it is critical that the machines stops at the right time. The TNC7 basic allows you to define events triggering a conditional stop. For example, the switching from machining feed rate to rapid traverse or the calling of a new tool can be an event for a conditional stop. On the control, you select the events that will trigger a program stop. In addition you can specify how to resume program run after the conditional stop, such as by pressing the OC 310 override controller or by turning it clockwise.

OC 310 override controller

The OC 310 is an innovative operating device. It replaces the feed-rate and rapid-traverse potentiometers on the TNC7 basic operating panel. The OC 310 is endlessly rotatable, and features a multicolor LED ring and an illuminated NC Start key. An integrated vibration motor gives haptic feedback to the user regarding specific events, such as when switching to the following:

- Minimum feed rate
- Maximum feed rate
- 100% feed rate

An integrated intelligent function detects a rapid turning down and automatically sets the feed-rate value to 0.

Positioning with an electronic handwheel

Fine motion control of axes

You can set up the workpiece by manually jogging the axes with the axis direction keys, but this task is easier and more finely controllable with the electronic handwheels from HEIDENHAIN.

In this method, the axis slides are moved by the feed motor in accordance with the handwheel's rotation. For particularly high sensitivity, you can incrementally set the amount of traversing distance for each handwheel rotation.

Panel-mounted handwheel

The HR 130 panel-mounted handwheel from HEIDENHAIN can be integrated into the machine operating panel or mounted to a different part of the machine.

Portable handwheels

The HR 510, HR 520, and HR 550 portable handwheels are particularly helpful when you work in close proximity to the machine's workspace. The axis keys and certain function keys are integrated into the housing. In this way, you can switch axes and set up the machine at any time—regardless of where you happen to be standing. As a wireless handwheel, the HR 550 is ideal for use on large machines. If you no longer need the handwheel, simply attach it to the machine using its built-in magnets.

Expanded range of functions of the HR 520 and HR 550

- Definable traversing distance per revolution
- Display for operating mode, actual position value, programmed feed rate, handwheel offset, spindle speed, and error messages
- Override potentiometers for feed rate, handwheel offset, and spindle speed
- Selection of axes by means of keys and soft keys
- Keys for continuous traverse of the axes
- Emergency stop button
- Actual position capture
- NC Start/Stop
- Spindle on/off
- Soft keys for machine functions defined by the machine manufacturer

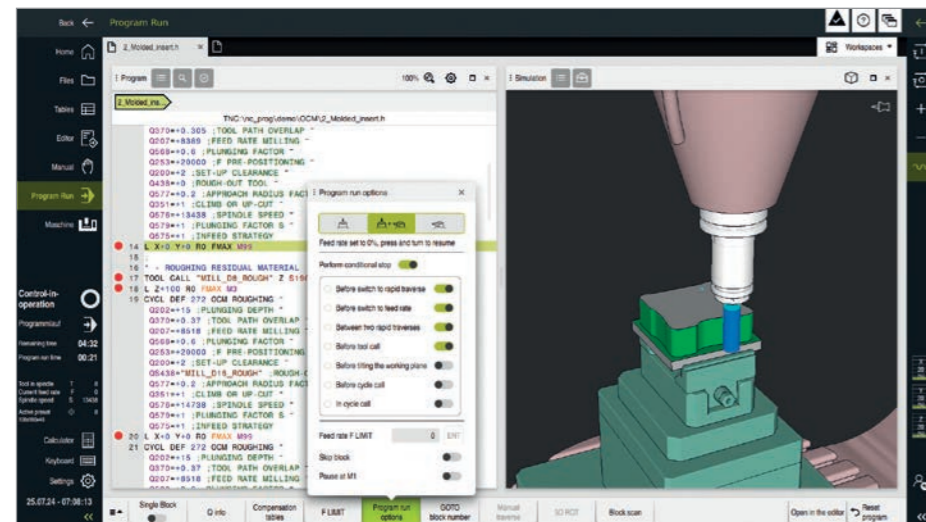

HR 550



Requirements	TNC7 basic	
NC software	NC SW 817621-18 and later	
Keyboard unit	TE 340 TE 340FS	ID 1320800-02 and higher ID 1352798-02 and higher
Machine operating panel	MB 340 MB 340FS	ID 1388531-xx ID 1388532-xx

Overview

User functions

User function	Standard	Options		
		SIK	SIK2	
Short description	✓	0-7 77 }	6-01-1	Basic version: 3 axes plus closed-loop spindle
	✓			A total of 4 additional NC axes or 3 additional NC axes plus second spindle Digital current and speed control
Program entry	✓ ✓	42	1-03-1	HEIDENHAIN Klartext Programming of contours graphically, and saving as Klartext program Importing of contours or machining positions from CAD files (STP, IGS, DXF) and saving them as a Klartext contour program or Klartext point table
Position feedback	✓ ✓ ✓			Nominal positions for lines and arcs in Cartesian coordinates or polar coordinates Incremental or absolute dimensions Display and entry in mm or inches
Tool compensation	✓ ✓	9	4-01-1	Tool radius in the working plane, and tool length Radius compensated contour look ahead for up to 99 blocks (M120) Three-dimensional tool-radius compensation for changing tool data without having to recalculate an existing program
Tool tables	✓			Multiple tool tables with any number of tools
Cutting data	✓	167	1-02-1	Automatic calculation of spindle speed, cutting speed, feed per tooth, and feed per revolution OCM: automatic calculation of overlap factor, milling feed rate, spindle speed, climb or up-cut milling, lateral infeed, cutting speed, material removal rate, recommended cooling
Constant contour speed	✓ ✓			With respect to the path of the tool center With respect to the cutting edge
Parallel operation	✓			Program creation with graphical support while another program is running
3D machining	✓	9	4-01-1	Motion control with highly smoothed jerk
		9		3D tool compensation via surface-normal vectors Changing the swivel-head angle with the electronic handwheel during program run without affecting the tool tip position (TCPM = Tool Center Point Management)
		9		Tool radius compensation perpendicular to the tool direction
		9		Manual traverse in the active tool-axis system
Rotary table machining	8 8		1-01-1	Programming of contours on an unrolled cylinder surface Feed rate in mm/min
Contour elements	✓ ✓ ✓ ✓ ✓ ✓ ✓			Straight line Chamfer Circular path Circle center Circle radius Tangentially connected arc Corner rounding
Contour approach and departure	✓ ✓			Approach and departure on a straight line: tangential or perpendicular Approach and departure on an arc
Adaptive feed control		45	2-31-1	AFC adapts the contouring feed rate to the current spindle power

User function	Standard	Options		
		SIK	SIK2	
Collision monitoring		40	5-03-1	Dynamic Collision Monitoring (DCM) • Graphic depiction of the active collision objects (high-resolution M3D format) • Tool carrier monitoring • Fixture monitoring
		140	5-03-2	Dynamic Collision Monitoring Version 2 (DCM v2), expansion of the functions of the Collision Monitoring software option with the following enhancements: • Graphically supported alignment of workholding equipment • Defining a reduced minimum distance between fixture and tool • 3D tool models (ToolShape)
Graphical programming	✓			Drawing function for easy graphical creation and editing of contours; conversion to HEIDENHAIN Klartext format with graphical support for workpiece drawings not dimensioned for NC
Program jumps	✓ ✓ ✓			Subprograms Program section repeat Any desired program as subprogram
Machining cycles	✓ ✓ ✓ ✓ ✓ ✓ ✓ ✓ ✓ ✓	167	1-02-1	Drilling, tapping (with or without floating tap holder), rectangular and circular pockets
				Peck drilling, reaming, boring, counterboring, centering
				Clearing level and oblique surfaces
				Complete machining of rectangular and circular pockets, rectangular and circular studs
				Multi-operation machining of straight and circular slots
				Circular and linear point patterns
				Point pattern: Data Matrix code
				Contour train, contour pocket
				Contour slot with trochoidal milling
				Engraving cycle: engrave text or numbers in a straight line or on an arc OEM cycles (special cycles developed by the machine manufacturer) can be integrated Optimized Contour Milling (OCM) cycles: optimization of roughing processes
Coordinate transformation	✓	8	1-01-1	Shifting, rotating, mirroring, scaling (axis-specific) Tilting the working plane, PLANE function
Q parameters Programming with variables	✓ ✓ ✓ ✓ ✓ ✓			Mathematical functions =, +, -, *, /, sin α, cos α, tan α, arc sin, arc cos, arc tan, a ⁿ , e ⁿ , ln, log, √a, √a ² + b ² Logical operations (=, ≠, <, >) Calculating with parentheses Absolute value of a number, constant π, negation, truncation of digits before or after the decimal point Functions for calculation of circles Functions for text processing
Programming aids	✓ ✓ ✓ ✓ ✓ ✓			Calculator Complete list of all current error messages Context-sensitive help function for error messages TNCguide: the integrated help system; user information available directly on the TNC basic Graphic support for the programming of cycles Comment and structure blocks in the NC program
CAD Model Optimizer		152	1-04-1	Optimize CAD models
Teach-in	✓			Application of actual positions directly in the NC program

Software options

User function	Standard	Options		
		SIK	SIK2	
Simulation Display modes	✓ ✓ ✓ ✓			Graphical simulation of the machining operation, even while another program is being executed Plan view / projection in six or more planes / 3D view, also in tilted working plane / 3D line graphics Detail enlargement Cutout view
Machining time	✓ ✓			Calculation of machining time in the Editor operating mode and in the Simulation workspace Display of the current machining time during program run
Returning to the contour	✓ ✓			Mid-program startup at any block in the program and movement to the calculated nominal position for continuation of the machining operation Program interruption, contour departure and return
Preset management	✓			One table for saving any reference points (presets)
Pallet tables	✓	154	2-05-1	Workpiece-oriented execution of pallet tables (with any number of entries for the selection of pallets, NC programs, and datums) Production process planning with Batch Process Manager
Touch probe cycles		17 17 17 48	2-01-1	Touch probe calibration Manual or automatic compensation of workpiece misalignment Manual or automatic preset setting Automatic tool and workpiece measurement KinematicsOpt: automatic measurement and optimization of the machine's kinematic model
Conversational languages	✓			English, German, Czech, French, Italian, Spanish, Portuguese, Swedish, Danish, Finnish, Dutch, Polish, Hungarian, Russian (Cyrillic), Chinese (traditional, simplified), Slovenian, Slovak, Norwegian, Korean, Turkish, Romanian
CAD Viewer	✓			Display of standardized CAD file formats on the TNC

Accessories

Accessories	
Electronic handwheels	<ul style="list-style-type: none"> • HR 510/HR 520 portable handwheels • HR 550 portable wireless handwheel • HR 130 panel-mounted handwheel
Workpiece measurement	<ul style="list-style-type: none"> • TS 260 workpiece touch probe with cable connection • TS 460/TS 760 workpiece touch probes with radio or infrared transmission • TS 642 workpiece touch probe with infrared transmission
Tool measurement	<ul style="list-style-type: none"> • TT 160 triggering tool touch probe • TT 460 triggering tool touch probe with radio or infrared transmission
Software for PCs	<ul style="list-style-type: none"> • RemoteAccess for remote diagnostics, monitoring, and operation • CycleDesign for creating your own cycle structure • TNCremo for data transfer—free of charge • TNCremoPlus for data transfer with live-screen function • StateMonitor for recording, evaluating, and visualizing machine data

Option number	Option	With NC software 81762x- and later		
			SIK	SIK2
0 to 3	6-01-1*	Control Loop Qty.	18	Additional control loop
8	1-01-1	Adv. Function Set 1	18	Rotary table machining <ul style="list-style-type: none"> • Programming of cylindrical contours as if in two axes • Feed rate in mm/min Interpolation: circular in three axes with tilted working plane Coordinate conversion: tilting the working plane, and the PLANE function
9	4-01-1	Adv. Function Set 2	18	Interpolation: straight line in more than four axes (export license required) 3D machining <ul style="list-style-type: none"> • 3D tool compensation via surface normal vectors • Alteration of the swivel head angle via the electronic handwheel during program run without changing the position of the tool center point (TCPM = Tool Center Point Management) • Keeping the tool perpendicular to the contour • Tool radius compensation perpendicular to the tool direction • Manual traverse in the active tool-axis system
17	1-05-1	Touch Probe Functions	18	Touch probe functions <ul style="list-style-type: none"> • Workpiece misalignment compensation, preset setting • Automatic tool and workpiece measurement • Touch probe input enabled for non-HEIDENHAIN touch probes
18	3-03-1	HEIDENHAIN DNC	18	Communication with external PC applications over COM component
21	4-02-1	Adv. Function Set 3	18	<ul style="list-style-type: none"> • Handwheel superimpositioning: superimpose handwheel positioning during program run • Tool compensation: radius-compensated contour precalculation (LOOK AHEAD)
24	6-03-1	Gantry Axes	18	Synchronized axes – gantry axes, tandem tables
40	5-03-1	Collision Monitoring	18	Dynamic Collision Monitoring (DCM) for defining machine components as collision objects. The TNC7 basic monitors the defined collision objects during all machine movements. <ul style="list-style-type: none"> • Graphic depiction of the active collision objects (high-resolution M3D format) • Tool carrier monitoring • Fixture monitoring
42	1-03-1	CAD Import	18	Import of contours from 2D and 3D models (e.g., STEP, IGES, DXF)
45	2-31-1	Adaptive Feed Contr.	18	Adaptive Feed Control (AFC)
46	7-01-1	Python OEM Process	18	Execution of Python applications
48	2-01-1	KinematicsOpt	18	Touch-probe cycles for the automatic measurement of rotary axes
49	6-02-1	Double Speed Axes	18	Short control-loop cycle times for a direct drive motor

* Can be ordered multiple times in the desired quantity. The control automatically takes all enablings into account.

Option number		Option	With NC software 81762x- and later	
SIK	SIK2			
56 to 61	3-02-1*	OPC UA NC Server	18	Reliable and stable interface for the connection of state-of-the-art industry applications; uncomplicated thanks to the use of standardized designs. Each of the six SIK options enables an incoming OPC UA connection via an application certificate.
77	6-01-1	4 Additional Axes	18	Four additional control loops
93	2-03-1	Ext. Tool Management	18	Extended tool management <ul style="list-style-type: none"> • Tooling list (list of all tools of the NC program) • T usage sequence (sequence of all tools inserted during the program)
133	3-01-1	Remote Desk. Manager	18	Display and remote operation of external computer units (e.g., a Windows PC)
140	5-03-1	Collision Monitoring v2	18	Dynamic Collision Monitoring Version 2 (DCM v2) with graphically supported alignment of workholding equipment (includes all functions of the Collision Monitoring software option)
141	2-20-1	Cross Talk Comp.	18	CTC: compensation of axis couplings
142	2-21-1	Position Adapt. Contr.	18	PAC: position-dependent adaptation of the control parameters
143	2-22-1	Load Adapt. Contr.	18	LAC: load-dependent adaptation of the control parameters
144	2-23-1	Motion Adapt. Contr.	18	MAC: motion-dependent adaptation of the control parameters
145	2-30-1	Active Chatter Contr.	18	ACC: active suppression of chatter during heavy machining
146	2-24-1	Machine Vibr. Contr.	18	Damping of machine oscillations to improve workpiece surfaces. The following functions are part of Machine Vibration Control (MVC): <ul style="list-style-type: none"> • Active Vibration Damping (AVD): active damping of vibrations in the control loop • Frequency Shaping Control (FSC): reduction of vibration inducement by means of frequency-based feedforward control
152	1-01-1	CAD Model Optimizer	18	Conversion and optimization of CAD models <ul style="list-style-type: none"> • Fixtures • Workpiece blank • Finished part
154	2-05-1	Batch Process Mngr.	18	Batch Process Manager for easy planning and execution of multiple production jobs
155	5-02-1	Component Monitoring	18	Monitoring for component overloading and wear
159	1-07-1	Model Aided Setup	18	Graphically supported alignment of workpieces: <ul style="list-style-type: none"> • Determining the position and misalignment of a workpiece with only one touch probe function • Probing of complex workpieces, such as with free-form surfaces or undercuts • Graphic support: The clamping situation and potential touch points are shown in the Simulation workspace using a 3D model

* Can be ordered multiple times in the desired quantity. The control automatically takes all enablings into account.

Option number		Option	With NC software 81762x- and later	
SIK	SIK2			
160	6-30-1	Integrated FS: Basic	18	Enabling of functional safety and four safe control loops
161	6-30-2	Integrated FS: Full	18	Enables functional safety and the maximum number of safe control loops
162 to 166	6-30-2*	FS Control Loop Qty.	18	Additional safe control loop 1 to 5
167	1-02-1	Opt. Contour Milling		OCM: optimize roughing processes and fully utilize milling tools with the integrated cutting data calculator
169	6-30-2	FS Control Loop Qty.	18	Enables all FS axis options or control loops. The software options Integrated FS: Basic as well as FS Control Loop Qty. (162 to 166) must already be set.

* Can be ordered multiple times in the desired quantity. The control automatically takes all enablings into account.

Specifications	Standard	Option	
Components	✓ ✓ ✓ ✓		MC main computer CC or UxC controller unit Multitouch operation TE operating panel (suitable for 16-inch screen)
Operating system	✓		HEROS 5 real-time operating system for machine control
Memory	✓		21.7 GB on CFR (total capacity: 60 GB) 7.7 GB on CFR (total capacity: 30 GB)
Input resolution and display step	✓ ✓		Linear axes: down to 0.01 µm Rotary axes: down to 0.00001°
Interpolation	✓ ✓ ✓	8	Linear in 4 axes Circular in 2 axes Circular in 3 axes with tilted working plane Helical: superimposition of circular and straight paths
Block processing time	✓		≤ 1.5 ms (3D straight line without radius compensation)
Axis feedback control	✓ ✓ ✓ ✓		Position-loop resolution: signal period of the position encoder/4096 Position controller cycle time: 200 µs (100 µs with the Double Speed Axes software option) Speed controller cycle time: 200 µs (100 µs with the Double Speed Axes software option) Current controller cycle time: minimum 100 µs (minimum 50 µs with the Double Speed Axes software option)
Error compensation	✓ ✓		Linear and nonlinear axis error, backlash, reversal peaks during circular movements, reversal error, thermal expansion Static friction, sliding friction
Data interfaces	✓ ✓ ✓	18 56-61	Network interface for remote operation of the TNC using the TNCremo or TNCremoPlus software from HEIDENHAIN 2 x Ethernet interface, 1 Gigabit USB 3.0 (and one USB 2.0 on the operating panel); the number of ports depends on the hardware used HEIDENHAIN DNC for communication between a Windows application and the TNC (DCOM interface) HEIDENHAIN OPC UA NC Server Reliable and stable interface for the connection of state-of-the-art industrial applications
Diagnostics	✓		Fast and simple troubleshooting through integrated diagnostic aids
Ambient temperature	✓ ✓		Operation: +5 °C to +40 °C Storage: -20 °C to +60 °C

Control	TNC7 NC software 34059x-18	TNC7 basic NC software 81760x-18
Area of application	High-end milling/turning/grinding	Standard milling
Simple machining centers (up to 8 control loops, max. 2 of which are spindles)	✓	✓
Machine tools / machining centers (up to 24 control loops, max. 4 of which are spindles)	✓	–
Milling/turning/grinding operations (up to 18 control loops + 2 spindles)	Option	–
Program entry		
HEIDENHAIN Klartext	✓	✓
ISO programming	✓	✓
Graphical programming	✓	✓
CAD Import	Option	Option
CAD Viewer	✓	✓
FK free contour programming	✓	Option
Extended milling and drilling cycles	✓	Option
OCM cycles	Option	Option
Turning cycles	Option	–
Functions for grinding	Option	–
Touch probe cycles	✓	Option
Setup		
Setting up the workpiece with graphic support	Option	Option
Calibrating fixtures with graphical support	Option	Option
Program execution		
5-axis simultaneous machining	Option	–
Monitoring functions		
Dynamic collision monitoring, version 2	Option	Option
Process monitoring	Option	–
Component monitoring	Option	Option
Adaptive Feed Control (AFC)	Option	Option
NC program memory	SSDR: 189 GB CFR: 21.7 GB	CFR: 21.7 GB CFR: 7.7 GB
Block processing time	< 0.5 ms	1.5 ms
Input resolution and display step (standard)	0.01 µm	0.01 µm
Screen and keyboard	19-inch / 24-inch touchscreen	16-inch touchscreen
Touchscreen	✓	✓

HEIDENHAIN

Mastering nanometer accuracy



HEIDENHAIN

DR. JOHANNES HEIDENHAIN GmbH
Dr.-Johannes-Heidenhain-Straße 5
83301 Traunreut, Germany

☎ +49 8669 31-0
☎ +49 8669 32-5061
✉ info@heidenhain.de

www.heidenhain.com



HEIDENHAIN
worldwide