



## TNC 128

The Compact Straight-Cut Control for Milling, Drilling, and Boring Machines

**Information for the  
Machine Tool Builder**

# TNC straight-cut control from HEIDENHAIN

## General information

<b>TNC 128</b>	<ul style="list-style-type: none"><li>• Straight cut control for <b>milling, drilling, and boring machines</b></li><li>• Axes: 6 control loops, of which up to 2 are configurable as spindles</li><li>• Analog nominal-value interface to the drives (<math>\pm 10</math> V)</li><li>• Compact design: Screen, keyboard, and main computer all in one unit</li><li>• Dimensions: 400 mm x 450 mm x 91 mm</li><li>• Integrated 12.1-inch TFT color flat-panel display</li><li>• Storage medium for NC programs: CompactFlash memory card</li><li>• Programming in HEIDENHAIN Klartext format</li><li>• Standard milling, drilling, and boring cycles</li><li>• Touch probe cycles</li><li>• Short block processing time</li></ul>
<b>System test</b>	Controls, motors, and encoders from HEIDENHAIN are in most cases integrated as components in larger systems. In these cases, comprehensive tests of the complete system are required, irrespective of the specifications of the individual devices.
<b>Parts subject to wear</b>	Controls from HEIDENHAIN include parts subject to wear, particularly the backup battery and fans.
<b>Standards</b>	Standards (ISO, EN, etc.) apply only where explicitly stated in the brochure.
<b>Note</b>	Microsoft, Windows 7, 8, 10 and Internet Explorer are registered trademarks of Microsoft Corporation. Intel, Intel Core, and Celeron are registered trademarks of Intel Corporation.
<b>Validity</b>	<p>The features and specifications described here apply to the following control and NC software versions:</p> <p><b>TNC 128 with NC software version</b> 771841-07 (no export license required)</p> <p>This brochure supersedes all previous editions, which thereby become invalid. <b>Subject to change without notice.</b></p>
<b>Requirements</b>	Some of these specifications require particular machine configurations. Please also note that, for some functions, a special PLC program must be created by the manufacturer.

# Contents

<b>TNC straight-cut control from HEIDENHAIN</b>	<b>2</b>
<b>Overview tables</b>	<b>4</b>
<b>Control components</b>	<b>12</b>
<b>Accessories</b>	<b>16</b>
<b>Cable overview</b>	<b>24</b>
<b>Technical description</b>	<b>26</b>
<b>Data transfer and communication</b>	<b>41</b>
<b>Mounting information</b>	<b>44</b>
<b>Overall dimensions</b>	<b>46</b>
<b>General information</b>	<b>57</b>
<b>Subject index</b>	<b>59</b>

Please refer to the **page references** in the **tables** with the specifications.

# Overview tables

## Overview of TNC 128 components

<b>Control system</b>	<b>TNC 128</b>	<b>Page</b>
<b>Main computer</b>	<b>MC 128</b>	12
Memory medium	<b>CFR</b> CompactFlash memory card	12
NC software license	On <b>SIK component</b>	12
<b>Screen</b>	12.1-inch color flat-panel display (integrated)	
<b>Operating panel</b>	Integrated	
<b>Machine operating panel</b>	Integrated	14
<b>Encoder input board</b>	Necessary starting with 4 axes and closed-loop spindle	13
<b>Connecting cables</b>	✓	24

# Accessories

Accessory	TNC 128	Page
<b>Electronic handwheels</b>	<ul style="list-style-type: none"> <li>• <b>HR 510 FS</b> portable handwheel, or</li> <li>• <b>HR 520 FS</b> portable handwheel with display, or</li> <li>• <b>HR 550 FS</b> portable wireless handwheel with display, or</li> <li>• <b>HR 130</b> panel-mounted handwheel, or</li> <li>• Up to three <b>HR 150</b> panel-mounted handwheels via HRA 110 handwheel adapter</li> </ul>	17
<b>Workpiece touch probes</b>	<ul style="list-style-type: none"> <li>• <b>TS 260</b> touch trigger probe with cable connection, or</li> <li>• <b>KT 130</b> edge finder with cable connection</li> </ul>	16
<b>Tool touch probes</b>	<ul style="list-style-type: none"> <li>• <b>TT 160</b> touch trigger probe</li> </ul>	16
<b>PLC input/output system</b>	For additional internal PLC inputs and outputs <b>PL 510</b> consisting of PLB 51x basic module and I/O modules	15
<b>USB hub</b>	✓	42
<b>Snap-on keys</b>	For controls and handwheels	20
Accessories / Software	TNC 128	Page
<b>PLCdesign<sup>1)</sup></b>	PLC development software	37
<b>KinematicsDesign<sup>1)</sup></b>	Software for creation of kinematic models	31
<b>TNCremo<sup>2)</sup>, TNCremoPlus<sup>2)</sup></b>	Data transfer software (TNCremoPlus with "live" screen)	42
<b>ConfigDesign<sup>1)</sup></b>	Software for configuring the machine parameters	33
<b>CycleDesign<sup>1)</sup></b>	Software for creating cycle structures	40
<b>TNCkeygen<sup>1)</sup></b>	Software for enabling SIK options for a limited time, and for single-day access to the OEM area	12
<b>TNCscope<sup>1)</sup></b>	Software for data recording	34
<b>TeleService<sup>1)3)</sup></b>	Software for remote diagnostics, monitoring, and operation	34
<b>RemoTools SDK<sup>1)</sup></b>	Function library for developing customized applications for communication with HEIDENHAIN controls	43
<b>TNCtest<sup>1)</sup></b>	Software for creation and execution of an acceptance test	35
<b>TNCanalyzer<sup>1)</sup></b>	Software for the analysis and evaluation of service files	35

<sup>1)</sup> Available to registered customers for downloading from the Internet

<sup>2)</sup> Available to all customers (without registration) for downloading from the Internet

<sup>3)</sup> Software release module required

# Specifications

Specifications	TNC 128	Page
<b>Axes</b>	6 control loops, of which up to 2 are configurable as spindles	27
PLC axes	✓	27
Central drive	✓	27
Open-loop axes	✓	27
<b>Main spindles</b>	<i>Milling</i> : max. 2; second spindle can be controlled by PLC alternately with the first	
Analog nominal speed value	Up to 100 000 rpm	28
Digital control over PLC outputs	✓	
Position-controlled spindle	✓	28
Oriented spindle stop	✓	28
Gear shifting	✓	28
<b>NC program memory</b>	1.8 GB	
<b>Input resolution and display step</b>		
Linear axes	0.1 µm	27
Rotary axes	0.0001°	27
<b>Axis feedback control</b>	Analog speed command interface ± 10 V (X8)	30
With following error	✓	
With feedforward	✓	
<b>Cycle times</b>		
Block processing	6 ms	
Path interpolation	3 ms	
<b>Permissible temperature range</b>	Operation: In electrical cabinet: 5 °C to 40 °C In operating panel: 0 °C to 50 °C Storage: -20 °C to 60 °C	

# Interfacing to the machine

Interfacing to the machine	TNC 128	Page
<b>Error compensation</b>	✓	32
Linear axis error	✓	32
Nonlinear axis error	✓	32
Backlash	✓	32
Hysteresis	✓	32
Thermal expansion	✓	32
Static friction	✓	32
Sliding friction	✓	32
<b>Integrated PLC</b>	✓	36
Program format	Statement list	36
Program input at the control	By external USB keyboard	36
Program input via PC	✓	36
Symbolic PLC-NC interface	✓	36
PLC memory	350 MB	36
PLC cycle time	9 ms to 30 ms (adjustable)	36
PLC inputs, DC 24 V <sup>1)</sup>	31 (expandable via PL)	15
PLC outputs, DC 24 V <sup>1)</sup>	31 (expandable by PL)	15
Inputs for PT 100 thermistors	Via PL	15
<b>PLC functions</b>	✓	36
Small PLC window	✓	36
PLC soft keys	✓	36
PLC positioning	✓	37
PLC basic program	✓	39
<b>Integration of applications</b>		38
High-level language programming	Python programming language used in combination with the PLC (option 46)	38
User interfaces can be custom-designed	Create specific user interfaces of the machine tool builder with the programming language Python. The standard version provides 10 MB of memory for programs. Additional memory can be enabled via option 46.	38

<sup>1)</sup> Further PLC inputs/outputs over PL 510 for connection to MC

<b>Interfacing to the machine</b>	<b>TNC 128</b>	<b>Page</b>
<b>Commissioning and diagnostic aids</b>		33
ConfigDesign	Software for creating the machine configuration	33
Integrated oscilloscope	✓	33
Trace function	✓	34
API DATA function	✓	34
Table function	✓	34
OLM (online monitor)	✓	34
Log	✓	34
Commissioning wizard	For analog axes	33
<b>Data interfaces</b>	✓	
Ethernet	1000BASE-T	41
USB	Rear: 2 x USB 3.0 Front: USB 2.0	41
V.24/RS-232-C	✓	41
<b>Protocols</b>		41
Standard data transmission	✓	41
Blockwise data transfer	✓	41
LSV2	✓	41
<b>Encoder inputs</b>		29
Position	4 (optional: 5)	29
Incremental	1 V <sub>PP</sub>	29
Absolute	EnDat 2.1	29

1) Further PLC inputs/outputs over PL 510 for connection to MC



# User functions

User function			TNC 128
	Standard	Option	
<b>Short description</b>	✓	0 1	Basic version: 3 axes plus closed-loop spindle 1st additional axis for 4 axes plus closed-loop or open-loop spindle 2nd additional axis for 5 axes plus open-loop spindle
<b>Program entry</b>	✓		HEIDENHAIN Klartext
<b>Position values</b>	✓ ✓ ✓		Nominal positions for straight lines in Cartesian coordinates Incremental or absolute dimensions Display and entry in mm or inches
<b>Tool tables</b>	✓		Multiple tool tables with any number of tools
<b>Cutting data</b>	✓		Automatic calculation of spindle speed, cutting speed, feed per tooth, and feed per revolution
<b>Fixed cycles</b>	✓ ✓ ✓ ✓ ✓ ✓ ✓		Drilling, conventional and rigid tapping Rectangular pockets Face milling Peck drilling, reaming, boring, counterboring, centering Multi-operation machining of rectangular pockets Cartesian and polar point patterns OEM cycles (special cycles developed by the machine tool builder) can be integrated
<b>Program jumps</b>	✓ ✓ ✓		Subprograms Program-section repeats Calling any program as a subprogram
<b>Coordinate transformation</b>	✓		Shifting, mirroring, scaling (axis-specific)
<b>Q parameters Programming with variables</b>	✓ ✓ ✓ ✓ ✓		Mathematical functions =, +, -, *, /, sin $\alpha$ , cos $\alpha$ , tan $\alpha$ , arc sin, arc cos, arc tan, $a^n$ , $e^n$ , ln, log, angle $\alpha$ from sin $\alpha$ and cos $\alpha$ , square root of a, square root of ( $a^2 + b^2$ ) Logical operations (=, = /, <, >) Calculating with parentheses Absolute value of a number, constant $\pi$ , negation, truncation of digits before or after the decimal point Functions for calculation of circles
<b>Programming aids</b>	✓ ✓ ✓ ✓ ✓ ✓		Calculator Complete list of all current error messages Context-sensitive help function for error messages TNCguide: the integrated help system. User information available directly on the TNC Graphical support for programming cycles Comment and structure blocks in the NC program
<b>CAD viewer</b>	✓		Display of standardized CAD file formats on the TNC
<b>Teach-In</b>	✓		Actual positions can be transferred directly into the NC program
<b>Test graphics Depictions</b>	✓ ✓ ✓		Graphical simulation before a program run, even while another program is running Plan view / projection in 3 planes / 3-D view, also in tilted working plane / 3-D line graphics Detail zoom
<b>Programming graphics</b>	✓		In Programming and Editing mode, the contours of entered NC blocks are rendered (2-D pencil-trace graphics), even while another program is running
<b>Program-run graphics Display modes</b>	✓ ✓		Graphical simulation during real-time machining Plan view / projection in 3 planes / 3-D view

User function	Standard	Option	TNC 128
<b>Machining time</b>	✓ ✓		Calculation of machining time in the Test Run operating mode Display of the current machining time in the Program Run operating modes
<b>Returning to the contour</b>	✓ ✓		Mid-program startup in any block in the program, returning the tool to the calculated nominal position to continue machining Program interruption, contour departure and return
<b>Preset management</b>	✓		For saving any reference points
<b>Datum tables</b>	✓		Multiple datum tables for storing workpiece-specific datums
<b>Touch probe cycles</b>	✓ ✓		Calibrating the touch probe Reference-point setting
<b>Conversational languages</b>	✓		English, German, Czech, French, Italian, Spanish, Portuguese, Dutch, Swedish, Danish, Finnish, Norwegian, Slovenian, Slovak, Polish, Hungarian, Russian (Cyrillic), Romanian, Turkish, Chinese (traditional and simplified), Korean

# Options

Option number	Option	As of NC software 771841-	ID	Comment	Page
<b>0</b>	Additional Axis 1	01	354540-01	Additional control loop 1	13
<b>1</b>	Additional Axis 2	01	353904-01	Additional control loop 2	13
<b>17</b>	Touch probe functions	01	634063-01	<b>Touch probe cycles</b> <ul style="list-style-type: none"> <li>• Setting of presets</li> <li>• Tool and workpiece measurement</li> <li>• Touch probe input enabled for non-HEIDENHAIN systems</li> </ul>	40
<b>18</b>	HEIDENHAIN DNC	01	526451-01	Communication with external PC applications over COM component	43
<b>46</b>	Python OEM process	01	579650-01	Execute Python applications	38
<b>137</b>	State Reporting	07	1232242-01	State Reporting Interface (SRI): provision of operating statuses	

# Control components

## Main computer

### TNC 128

The standard version of the TNC 128 features four inputs for position encoders. It can be enhanced with options.

The TNC 128 includes the MC 128 main computer with:

- Intel Celeron 1047 processor (1.4 GHz, dual-core)
- 2 GB SDRAM main memory
- 12.1-inch TFT color flat-panel display; resolution 1024 x 768 pixels
- TNC keyboard
- Machine operating panel
- PLC
- Interface to handwheel and touch probes
- Further interfaces (PLC expansion, Ethernet, USB 2.0 on front, two USB 3.0 on rear, RS-232-C/V.24)

To be ordered separately, and installed in the main computer by the OEM:

- **CFR** CompactFlash memory card with the NC software
- The **System Identification Key component (SIK)** for enabling control loops and options

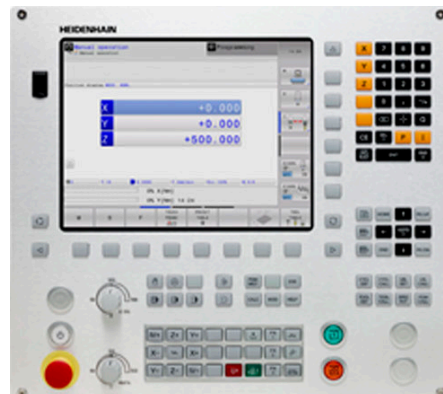

### MC 128

Position inputs	4 x 1 V <sub>PP</sub> or EnDat (optional 5 x 1 V <sub>PP</sub> or EnDat)
Mass	8 kg ID 803344-xx

### Power supply

Supply voltage <sup>1)</sup>	24 V DC
Power consumption	60 W

<sup>1)</sup> PELV according to EN 61800-5-1 for low voltage electrical separation

### Memory medium

The storage medium is a CFR (= CompactFlash Removable) compact flash memory card. It contains the NC software and is used to store NC and PLC programs. The storage medium is removable and must be ordered separately from the main computer.

This CFR uses the fast SATA protocol (CFast).

#### CFR CompactFlash 8 GB

Free capacity for NC programs	1.8 GB
Free capacity for PLC programs	350 MB
No export license required	ID 1038498-57



CFR CompactFlash

### SIK component

The SIK component contains the **NC software license** for enabling control loops and software options. It provides the main computer with an unambiguous ID code—the SIK number. The SIK component is ordered and shipped separately. It must be inserted into a special slot in the MC main computer.

The SIK component with the NC software license is available in various versions, depending on the enabled control loops and options. Additional control loops can be enabled later by entering a keyword. HEIDENHAIN provides the keyword, which is based on the SIK number.

When ordering, please provide the SIK number of your control. When the keywords are entered in the control, they are saved in the SIK component. This enables and activates the options. Should servicing become necessary, the SIK component must be inserted into the replacement control in order to enable all of the required options.



SIK component

**Master keyword (general key)**

For the commissioning of the TNC 128, there is a master keyword (general key) that enables all options for a single 90-day period. After this period, only those options with the correct keywords will be active. The general key is activated via a soft key.

**TNCkeygen (accessory)**

TNCkeygen is a collection of PC software tools for generating enabling keys for HEIDENHAIN controls for a limited period of time.

With **OEM Key Generator**, you can generate enabling keys for software options by entering the SIK number, the option to be enabled, the duration, and a manufacturer-specific password. The enabling period is limited to 10 to 90 days. Each option can be enabled only once. This option enabling is independent of the general key.

The **OEM daily key generator** generates an enabling key for the protected OEM area. The operator is thereby given access to the area on the day the key was generated.

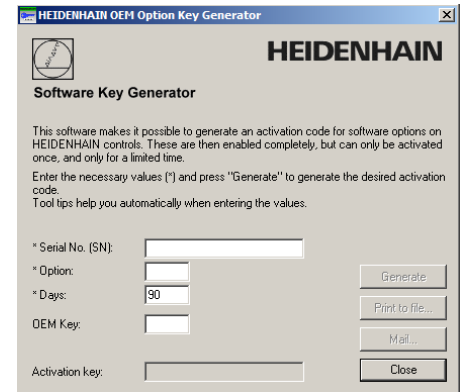

**NC software license**

SIK with software license and enabling for

- 4 control loops** (3 axes plus closed-loop spindle) ID 822102-51
- 4 control loops and option 17** (touch probe) ID 822102-55
- 5 control loops** (4 axes plus closed-loop spindle) ID 822102-52
- 6 control loops** (5 axes plus open-loop spindle) ID 822102-53

**Axis options**

With the NC software license for three axes, two additional control loops can be enabled later:

- 1st additional axis** ID 354540-01
- 2nd additional axis** ID 353904-01

**Encoder input board**

An additional encoder input board is required for axis configurations with four or more axes plus closed-loop spindle.

- Encoder input board** ID 554296-xx

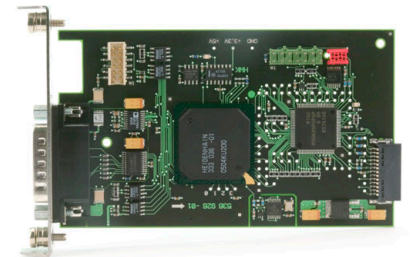

**Possible configurations**

Closed-loop axes	Spindle <sup>1)</sup>	NC software license for	Necessary options
3	Closed loop	4 control loops	–
4	Open loop	4 control loops	1st additional axis
		5 control loops	–
4	Closed loop	4 control loops	1st additional axis Encoder input board
		5 control loops	Encoder input board
5	Open loop	4 control loops	1st additional axis 2nd additional axis Encoder input board
		5 control loops	2nd additional axis Encoder input board

<sup>1)</sup> For the *open-loop spindle*, the TNC specifies the spindle speed as an analog nominal speed value. For the *closed-loop spindle*, position feedback is provided, for example, for oriented spindle stop.

<b>Options</b>	The capabilities of the TNC 128 can also be adapted at a later time with options to meet new requirements. These options are described on page 11. They are enabled by entering keywords based on the SIK number and are saved in the SIK component. Please provide your SIK number when ordering new options.
<b>TNC keyboard</b>	The keys for the Z axis, axis IV, and axis V are designed as snap-on keys and can be replaced by keys with other symbols (see <i>Snap-on keys</i> ).
<b>Export license</b>	An <b>export license</b> is generally <b>not</b> required for the TNC 128.
<b>Machine operating panel</b>	<p>The TNC 128 features an integrated machine operating panel.</p> <ul style="list-style-type: none"> <li>• 24 snap-on keys, which can be addressed directly via the PLC; 3 snap-on keys can be wired as desired</li> <li>• Operating elements (pre-assigned as per PLC basic program): control voltage on<sup>1)</sup>; emergency stop, NC start<sup>1)</sup>; NC stop<sup>1)</sup>; 4 axis keys; rapid traverse; unlock door; spindle start; spindle stop; coolant; rinse-water jet; chip removal (for other key symbols, see <i>Snap-on keys</i>)</li> <li>• Additional connections: Terminals for 8 PLC inputs and 8 PLC outputs (pre-assigned by default)</li> </ul> <p><sup>1)</sup> Keys illuminated, addressable via PLC</p>

# PL 510 PLC input/output system

## PL 510

If the PLC inputs/outputs of the control do not suffice, you can connect additional PL 51x PLC input/output systems. These external modular I/O systems consist of a PLB 51x basic module and one or more PLD 16-8 and PLA 4-4 input/output modules.



PL 510

## Basic modules

Basic modules feature slots for 4, 6 or 8 I/O modules. Mounted on standard NS 35 rails (DIN 46 227 or EN 50 022).

Supply voltage	DC 24 V
Power consumption	≈ 20 W
Mass	0.36 kg (bare)

Basic modules with HEIDENHAIN PLC interface

<b>PLB 510</b>	Slots for 4 I/O modules	ID 358849-01
<b>PLB 511</b>	Slots for 6 I/O modules	ID 556941-01
<b>PLB 512</b>	Slots for 8 I/O modules	ID 557125-01

Up to four PLB 510 modules and up to two PLB 511 or PLB 512 modules can be connected to the control. The maximum cable length to the last PLB 51x is 30 m.

## I/O modules

The I/O modules consist of one module with digital inputs/outputs and one analog module. For partially occupied basic modules, the unused slots must be occupied by an empty housing.

**PLD 16-8** ID 360916-11

I/O module for PL 5x0 with 16 digital inputs and 8 digital outputs.

The maximum power output per module is 200 W. A load of up to 2 A can be placed on each output. No more than four outputs may be loaded with 2 A at any given time.

Mass	0.2 kg
------	--------

**PLA 4-4** ID 366423-01

Analog module for PL 5x0 with 4 analog inputs for PT 100 thermistors  
4 analog inputs for ±10 V

Mass	0.2 kg
------	--------

## Empty housing

For unused slots of the system PL ID 383022-xx

# Accessories

## Touch probes

### Overview

The standard TNC 128 is equipped for the connection of touch probes for tool and workpiece measurement. These touch probes generate a trigger signal that saves the current position value to the NC. The EnDat interface makes touch probes intelligent and allows for greater convenience when connecting them to HEIDENHAIN controls. For more information on touch probes, please refer to the *Touch Probes for Machine Tools* brochure (ID 1113984).

### Workpiece measurement

The TS touch trigger probes and the KT edge finders feature a stylus for probing workpieces. HEIDENHAIN controls feature standard routines for aligning and measuring workpieces, and for setting presets. The touch probes are available with various clamping shanks. Assorted styli are available as accessories.

Touch probes with **cable connection for signal transmission** for machines with manual tool change:

KT 130 Edge finder for manual and controlled machines



KT 130

TS 260 TS 260: new generation touch probe for NC machines  
TS 268: like the TS 260, but with reduced deflection forces



TS 260

### Tool measurement

The touch probes for tool measurement from HEIDENHAIN are suited for probing stationary or rotating tools directly on the machine. The TNC 128 features standard cycles for the measurement of tool length and diameter, as well as of individual teeth. The TNC 128 automatically saves the measured tool dimensions in a tool table. It is also possible to measure tool wear between two machining steps.

With the **TT touch trigger probes**, the disk-shaped probe contact is deflected from its resting position by contact with the stationary or rotating tool, and a trigger signal is transmitted to the TNC 128.

TT 160 New generation touch probe; signal transmission to the control over connecting cable



TT 160



# Electronic handwheels

## Overview

Support for electronic handwheels is standard on the TNC 128:

- One **HR 550 FS** wireless handwheel, or
- One **HR 510** or **HR 520** portable handwheel, or
- One **HR 130** panel-mounted handwheel, or
- Up to three **HR 150** panel-mounted handwheels via **HRA 110**

## HR 510

Portable electronic handwheel with:

- Keys for actual-position capture and the selection of five axes
- Keys for traverse direction and three preset feed rates
- Three keys for machine functions (see below)
- Emergency stop button and two permissive buttons (24 V)
- Magnetic holding pads

All keys are designed as snap-on keys and can be replaced by keys with other symbols (see overview for HR 510 in *Snap-on keys for handwheels*).

	Keys	Without detent	With detent
<b>HR 510</b>	NC start/stop, spindle start (for basic PLC program)	ID 1119971-xx	ID 1120313-xx
	FCT A, FCT B, FCT C	ID 1099897-xx	–
	Spindle right/left/stop	ID 1184691-xx	–
<b>HR 510 FS</b>	NC start/stop, spindle start (for basic PLC program)	ID 1120311-xx	ID 1161281-xx
	FCT A, FCT B, FCT C	–	ID 1120314-xx
	Spindle start, FCT B, NC start	–	ID 1119974-xx

Mass ≈ 0.6 kg

## HR 520

Portable electronic handwheel with:

- Display for operating mode, actual position value, programmed feed rate and spindle speed, error messages
- Override potentiometers for feed rate and spindle speed
- Selection of axes via keys or soft keys
- Actual position capture
- NC start/stop
- Spindle on/off
- Keys for continuous traverse of the axes
- Soft keys for machine functions of the machine manufacturer
- Emergency stop button

	Without detent	With detent
<b>HR 520</b>	ID 670302-xx	ID 670303-xx
<b>HR 520 FS</b>	ID 670304-xx	ID 670305-xx

Mass ≈ 1 kg



HR 510



HR 520

Holder for HR 520

For attaching to a machine

ID 591065-xx

## HR 550 FS

Electronic handwheel with wireless transmission. Display, operating elements, and functions are like those of the HR 520

In addition:

- Functional safety (FS)
- Radio transmission range of up to 20 m (depending on environment)

**HR 550 FS** Without detent ID 1200495-xx  
With detent ID 1183021-xx

**Replacement battery** For HR 550 FS ID 623166-xx



HR 550 FS with HRA 551 FS

## HRA 551 FS

Handwheel holder for HR 550 FS

- For docking the HR 550 FS onto the machine
- Integrated battery charger for HR 550 FS
- Connections to the control and the machine
- Integrated transceiver
- HR 550 FS magnetically held to front of HRA 551 FS

**HRA 551 FS** ID 1119052-xx  
Mass ≈ 1.0 kg

For more information, see the *HR 550 FS* Product Information sheet.

## Connecting cables

	HR 510	HR 510 FS	HR 520	HR 520 FS	HR 550 FS with HRA 551 FS	
Connecting cable (spiral cable) to HR (3 m)	–	–	✓	✓	–	ID 312879-01
	✓	✓	–	–	–	ID1117852-03
Connecting cable with metal armor	–	–	✓	✓	–	ID 296687-xx
	✓	✓	–	–	–	ID 1117855-xx
Connecting cable without metal armor	–	–	✓	✓	✓ (max. 2 m)	ID 296467-xx
	✓	✓	–	–	–	ID 1117853-xx
Adapter cable for HR/HRA to MC, straight connector	✓	✓	✓	✓	✓ <sup>1)</sup>	ID 1161072-xx
Adapter cable for HR/HRA to MC, angled connector (1 m)	✓	✓	✓	✓	✓ <sup>1)</sup>	ID 1218563-01
Extension cable to adapter cable	✓	✓	✓	✓	✓ <sup>1)</sup>	ID 281429-xx

<sup>1)</sup> For maximum cable lengths up to 20 m between the MB and HRA 551 FS

<sup>2)</sup> For maximum cable lengths up to 50 m between the MB and HRA 551 FS

	HR 510	HR 510 FS	HR 520	HR 520 FS	HR 550 FS with HRA 551 FS	
Adapter cable for HRA to MC	–	–	–	–	✓ <sup>2)</sup>	ID 749368-xx
Extension cable to adapter cable	–	–	–	–	✓ <sup>2)</sup>	ID 749369-xx
Adapter connector for handwheels without functional safety	✓	–	✓	–	–	ID 271958-03
Adapter connector for handwheels with functional safety	–	✓	–	✓	✓	ID 271958-05

1) For maximum cable lengths up to 20 m between the MB and HRA 551 FS

2) For maximum cable lengths up to 50 m between the MB and HRA 551 FS

See also *Cable overview* on Page 24.

### HR 130

Panel-mounted handwheel with ergonomic control knob. It is attached to the MB 7x0 or the TE 7x5 either directly or via an extension cable.

<b>HR 130</b>	Without detent	ID 540940-03
	With detent	ID 540940-01
Mass	≈ 0.7 kg	



HR 130

### HR 150

Panel-mounted handwheel with ergonomic control knob for connection to the **HRA 110** handwheel adapter.

<b>HR 150</b>	Without detent	ID 540940-07
	With detent	ID 540940-06
Mass	≈ 0.7 kg	



HR 150

### HRA 110

Handwheel adapter for connection of up to three **HR 150** panel-mounted handwheels and two step switches for axis selection and configuration of the subdivision factor. The first and second handwheels are assigned to axes 1 and 2. The third handwheel is assigned to the axes via a step switch or via machine parameters. The position of the second step switch is evaluated over the PLC (e.g., to select the subdivision factor).

<b>HRA 110</b>		ID 261097-xx
Mass	≈ 1.5 kg	



HRA 110











# Snap-on keys for handwheels

## Snap-on keys





































The snap-on keys make it easy to replace the key symbols. In this way, the HR handwheel can be adapted to different requirements. The snap-on keys are available in packs of five keys.

### Overview for HR 520, HR 520 FS, and HR 550 FS





























#### Axis keys Orange

	ID 330816-42		ID 330816-24		ID 330816-43		ID 330816-37
	ID 330816-26		ID 330816-36		ID 330816-38		
	ID 330816-23		ID 330816-25		ID 330816-45		

#### Gray

	ID 330816-95		ID 330816-69		ID 330816-0W		ID 330816-0R
	ID 330816-96		ID 330816-0G		ID 330816-0V		ID 330816-0D
	ID 330816-97		ID 330816-0H		ID 330816-0N		ID 330816-0E
	ID 330816-98		ID 330816-71		ID 330816-0M		ID 330816-65
	ID 330816-99		ID 330816-72		ID 330816-67		ID 330816-66
	ID 330816-0A		ID 330816-63		ID 330816-68		ID 330816-19
	ID 330816-0B		ID 330816-64		ID 330816-21		ID 330816-16
	ID 330816-0C		ID 330816-18		ID 330816-20		ID 330816-0L
	ID 330816-70		ID 330816-17		ID 330816-0P		ID 330816-0K





















#### Machine functions

	ID 330816-0X		ID 330816-75		ID 330816-0T		ID 330816-86
	Black ID 330816-1Y		ID 330816-76		ID 330816-81		ID 330816-87
	Black ID 330816-30		ID 330816-77		ID 330816-82		ID 330816-88
	Black ID 330816-31		ID 330816-78		ID 330816-83		ID 330816-94
	Black ID 330816-32		ID 330816-79		ID 330816-84		ID 330816-0U
	ID 330816-73		ID 330816-80		ID 330816-89		ID 330816-91
	ID 330816-74		ID 330816-0S		ID 330816-85		ID 330816-3L

#### Spindle functions











	Red ID 330816-08		ID 330816-40		Red ID 330816-47		ID 330816-48
	Green ID 330816-09		ID 330816-41		Green ID 330816-46		ID 385530-5X

#### Other keys











	Black ID 330816-01		Red ID 330816-50		ID 330816-90		ID 330816-93
	Gray ID 330816-61		ID 330816-33		Black ID 330816-27		ID 330816-0Y
	Green ID 330816-11		ID 330816-34		Black ID 330816-28		Black ID 330816-4M
	Red ID 330816-12		ID 330816-13		Black ID 330816-29		ID 330816-3M
	Green ID 330816-49		Green ID 330816-22		ID 330816-92		ID 330816-3N

## Overview for HR 510 and HR 510 FS







Axis keys  
Orange

	ID 1092562-02		ID 1092562-05		ID 1092562-36		ID 1092562-08
	ID 1092562-03		ID 1092562-06		ID 1092562-09		
	ID 1092562-04		ID 1092562-07		ID 1092562-37		







Gray

	ID 1092562-28		ID 1092562-31		ID 1092562-24		ID 1092562-27
	ID 1092562-29		ID 1092562-32		ID 1092562-25		
	ID 1092562-30		ID 1092562-33		ID 1092562-26		













Machine functions

	Black ID 1092562-14		Black ID 1092562-15		Black ID 1092562-16		ID 1092562-42
	ID 1092562-43		ID 1092562-44				

Spindle functions

	ID 1092562-18		ID 1092562-19		Green ID 1092562-22		Red ID 1092562-17
	Red ID 1092562-38		ID 1092562-41				

Other keys

	Black ID 1092562-01		Green ID 1092562-23		ID 1092562-13		ID 1092562-35
	Green ID 1092562-20		ID 1092562-11		Black ID 1092562-10		Gray ID 1092562-39
	Red ID 1092562-21		ID 1092562-12		ID 1092562-34		Orange ID 1092562-40











# Snap-on keys for controls

## Snap-on keys







































The snap-on keys make it easy to replace the key symbols. In this way, the keyboard can be adapted to different requirements. The snap-on keys are available in packs of five keys.

### Overview of control keys



































#### Keys Orange

	ID 679843-31		ID 679843-54		ID 679843-C8		ID 679843-D4
	ID 679843-32		ID 679843-55		ID 679843-C9		
	ID 679843-53		ID 679843-88		ID 679843-D3		



















#### Gray

	ID 679843-03		ID 679843-13		ID 679843-93		ID 679843-B9
	ID 679843-04		ID 679843-14		ID 679843-94		ID 679843-C1
	ID 679843-05		ID 679843-43		ID 679843-B1		ID 679843-C2
	ID 679843-06		ID 679843-44		ID 679843-B2		ID 679843-C3
	ID 679843-07		ID 679843-67		ID 679843-B3		ID 679843-C4
	ID 679843-08		ID 679843-68		ID 679843-B4		ID 679843-C5
	ID 679843-09		ID 679843-69		ID 679843-B5		ID 679843-D9
	ID 679843-10		ID 679843-70		ID 679843-B6		ID 679843-E1
	ID 679843-11		ID 679843-91		ID 679843-B7		
	ID 679843-12		ID 679843-92		ID 679843-B8		































#### Machine functions

	ID 679843-01		ID 679843-30		ID 679843-74		ID 679843-C6
	ID 679843-02		ID 679843-40		ID 679843-76	<b>FCT C</b>	Black ID 679843-C7
	ID 679843-16		Green ID 679843-56	<b>FCT A</b>	Black ID 679843-95	<b>SPEC FCT</b>	ID 679843-D6
	ID 679843-22		Red ID 679843-57	<b>FCT B</b>	Black ID 679843-96		ID 679843-E3
	ID 679843-23		+		Black ID 679843-A1	<b>FCT RC</b>	ID 679843-E4
	ID 679843-24		-		ID 679843-A2		ID 679843-E6
	ID 679843-25		ID 679843-61		ID 679843-A3		ID 679843-E7
	ID 679843-26		ID 679843-62		ID 679843-A4		ID 679843-E8
	ID 679843-27	<b>FCT</b>	ID 679843-63		ID 679843-A5		
	ID 679843-28		ID 679843-64		ID 679843-A6		
	ID 679843-29		ID 679843-73		ID 679843-A9		

Spindle functions

	ID 679843-18		ID 679843-47		Red ID 679843-52		ID 679843-99
	ID 679843-19		ID 679843-48		ID 679843-65		Green ID 679843-D8
	ID 679843-20		ID 679843-49		Green ID 679843-71		ID 679843-F3
	ID 679843-21		ID 679843-50		ID 679843-72		
	ID 679843-46		ID 679843-51		Red ID 679843-89		

Other keys

	ID 679843-15		ID 679843-39		ID 679843-97		Black ID 679843-E2
	ID 679843-17		ID 679843-41		ID 679843-98		ID 679843-E5
	Gray ID 679843-33		ID 679843-42		ID 679843-A7		ID 679843-F2
	Black ID 679843-34		Red ID 679843-45		ID 679843-A8		ID 679843-F4
	Orange ID 679843-35		ID 679843-58		Black ID 679843-D1		ID 679843-F5
	ID 679843-36		ID 679843-66		Black ID 679843-D2		ID 679843-F6
	ID 679843-37		ID 679843-75		ID 679843-D5		
	ID 679843-38		Green ID 679843-90		Red ID 679843-D7		

Special keys

Snap-on keys can also be made with special key symbols for special applications. The laser labeling differs in appearance from the labeling of the standard keys. If you need keys for special applications, please consult your contact person at HEIDENHAIN.

# Cable overview

## TNC 128

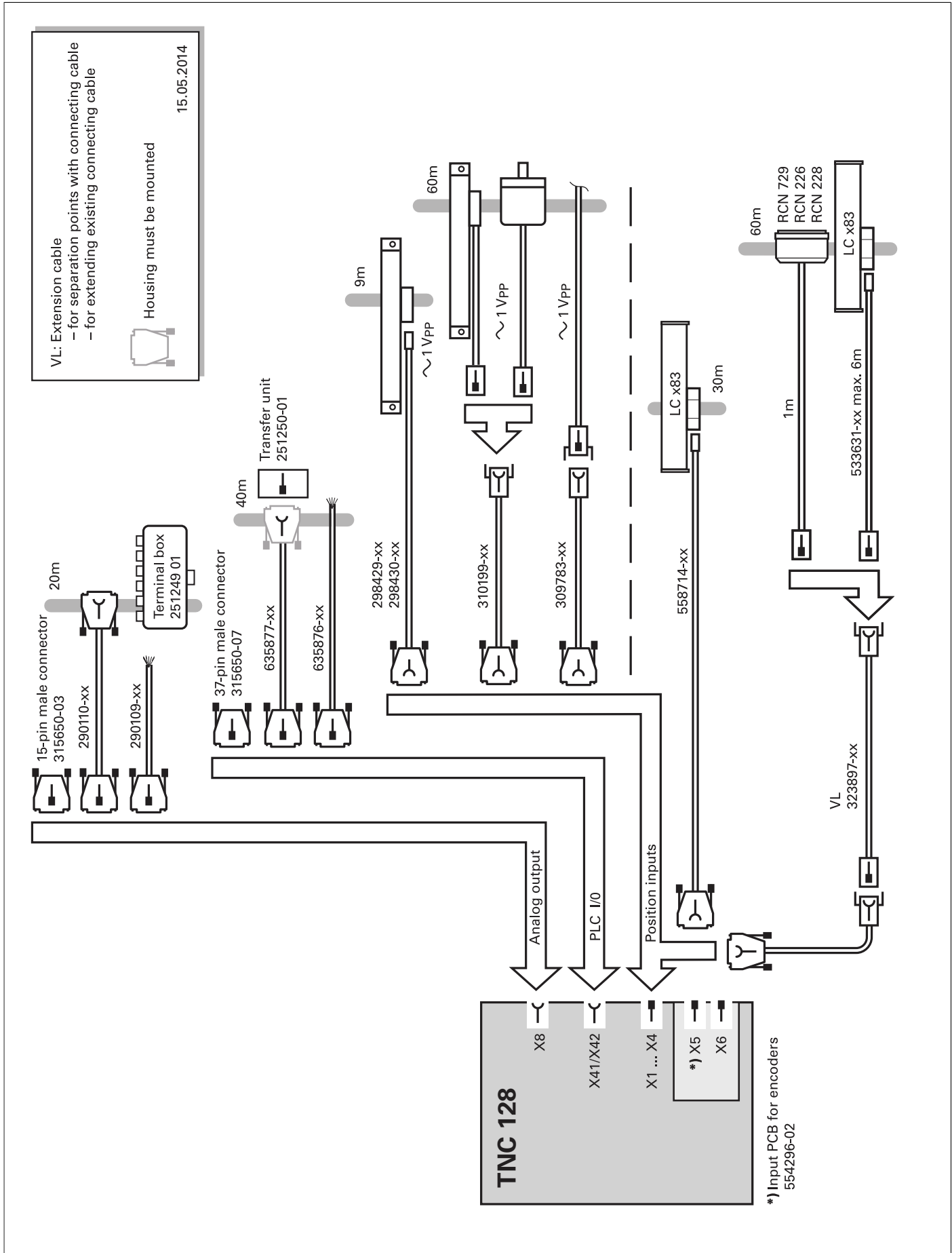



# Accessories

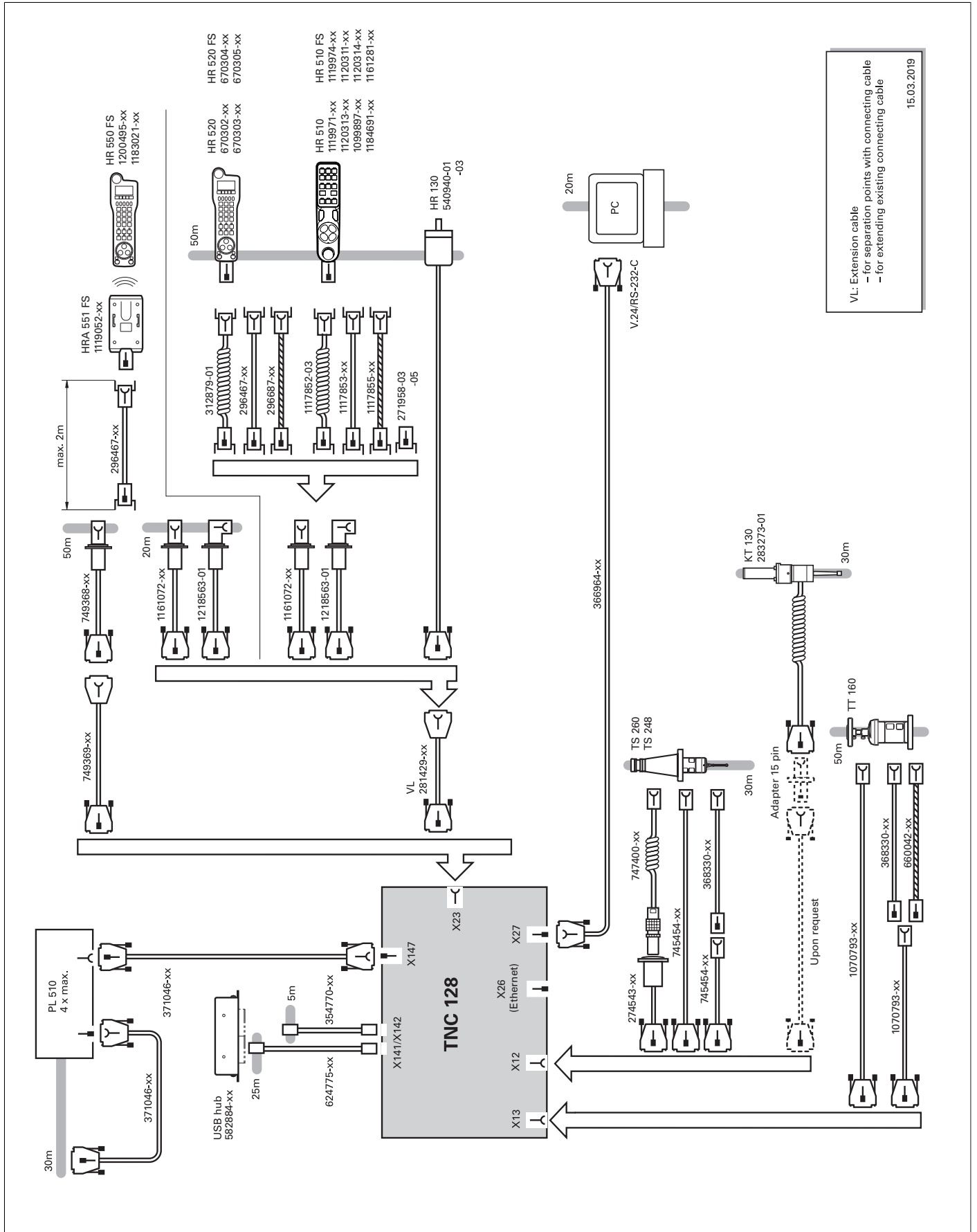

# Technical description

## Operating system

### HEROS 5

The TNC 128 works with the real-time capable HEROS 5 operating system (HEIDENHAIN Realtime Operating System). This future-oriented operating system contains the following powerful functions as part of its standard repertoire:

#### Network

- Network: management of network settings
- Printer: management of printers
- Shares: management of network shares
- VNC: virtual network computing server

#### Safety

- Portscan (OEM): port scanner
- Firewall: protection against undesired network access
- SELinux: protection against unauthorized changes to system files
- Sandbox: running applications in separated environments

#### System

- Backup/Restore: function for backing-up and restoring the control
- HELogging: evaluation and creation of log files
- Perf2: system monitor
- User administration: define users with different roles and access permissions

#### Tools

- Web browser: Firefox®\*
- Document Viewer: display PDF, TXT, XLS, and JPEG files
- File Manager: file explorer for managing files and memory media
- Gnumeric: spreadsheet calculations
- Leafpad: text editor for creating notes
- Ristretto: display of image files
- Orage Calendar: simple calendar function
- Screenshot: creation of screendumps
- Totem: media player for playing audio and video files

### User administration

The improper operation of a control often leads to unplanned machine downtime and costly scrap. The user administration feature can significantly improve process reliability through the systematic avoidance of improper operation. Through the configurable tying of permissions to user roles, access rights can be tailored to the given responsibilities of each operator.

- Logging on to the control with a user account
- User-specific HOME folder for simplified data management
- Role-based access to the control and network data

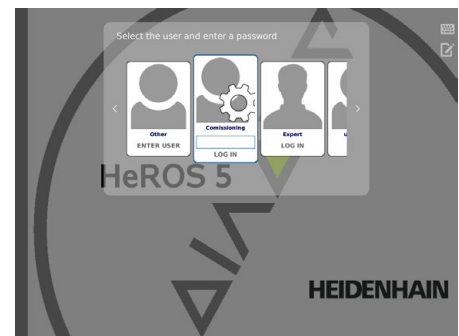

\* Firefox is a registered trademark of the Mozilla Foundation

# Axes

## Linear axes

The TNC 128 can control linear axes with any axis designation (X, Y, Z, U, V, W, ...).

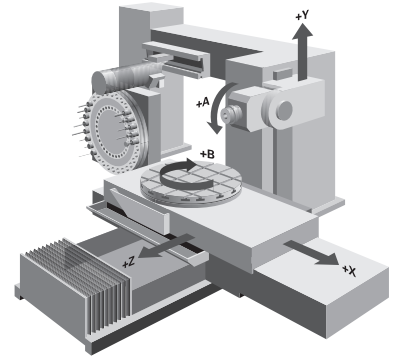

Display and programming

–99 999.999 to +99 999.999 [mm]

Feed rate in mm/min relative to the workpiece contour, or mm per spindle revolution

Feed rate override: 0 % to 150 %

Traverse range

–99 999.999 to +99 999.999 [mm]

The machine tool builder defines the traverse range. The user can set additional limits to the traverse range if he wishes to reduce the working space. Three different traverse ranges can be defined (selection via PLC).

## Rotary axes

The TNC 128 can control rotary axes with any axis designation (A, B, C, U, ...). Special parameters and PLC functions are available for rotary axes with Hirth coupling.

Display and programming

0° to 360° or  
–99 999.999 to +99 999.999 [°]

Feed rate in degrees per minute [°/min]

Traverse range

–99 999.999 to +99 999.999 [°]

The machine tool builder defines the traverse range. The user can set additional limits to the traverse range if he wishes to reduce the working space. Various traverse ranges can be defined per axis using parameter sets (selection by PLC).

## PLC axes

Axes can be defined as PLC axes. Programming is performed through M functions or OEM cycles. The PLC axes are positioned independently of the NC axes and are therefore designated as asynchronous axes.

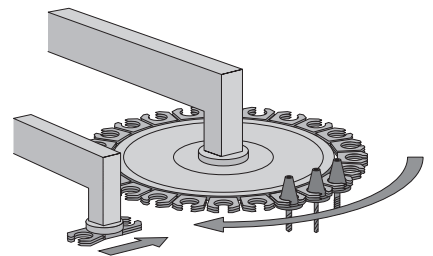

# Spindle

<b>Analog nominal speed value</b>	Up to 100 000 rpm
<b>Position-controlled spindle</b>	The position of the spindle is monitored by the control.
<b>Encoder</b>	HEIDENHAIN rotary encoder with sinusoidal voltage signals (1 V <sub>pp</sub> ) or EnDat interface.
<b>Tapping</b>	There are special cycles for tapping with or without floating tap holder. For tapping without floating tap holder, the spindle must be operated under position control.
<b>Spindle orientation</b>	With a position-controlled spindle, the spindle can be positioned exactly to 0.1°.
<b>Spindle override</b>	0 % to 150 %
<b>Gear ranges</b>	A separate nominal speed is defined for each gear range. The gear stages are controlled by the PLC.
<b>Multiple main spindles</b>	Up to two spindles can be controlled alternately. The spindles are switched by the PLC. One control loop is required for each active spindle.

# Encoders

## Overview

For speed and position control of the axes and spindle, HEIDENHAIN offers both incremental and absolute encoders.

## Incremental encoders

Incremental encoders have as their measuring standard a grating consisting of alternating lines and spaces. Relative movement between the scanning head and the scale causes the output of sinusoidal scanning signals. The measured value is calculated by counting the signals.

## Reference mark

When the machine is switched on, the machine axes need to traverse a reference mark for an accurate reference to be established between the measured value and the machine position. For encoders with distance-coded reference marks, the maximum travel until automatic reference mark evaluation for linear encoders is only 20 mm or 80 mm, depending on the model, or 10° or 20° for angle encoders.

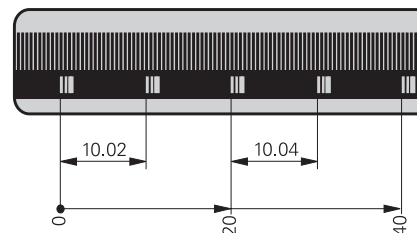

## Evaluation of reference marks

The routine for traversing the reference marks can also be started for specific axes via the PLC during operation (reactivation of parked axes).

## Output signals

Incremental encoders with sinusoidal output signals with  $\sim 1 V_{PP}$  levels are suitable for connection to HEIDENHAIN numerical controls.

## Absolute encoders

With absolute encoders, the position information is contained in several coded tracks. Thus, an absolute reference is available immediately after switch-on. A reference-mark traverse is not necessary. Additional incremental signals are output for highly dynamic control loops.

## EnDat interface

The TNC 128 features the serial EnDat 2.1 interface for the connection of absolute encoders.

**Note:** The EnDat interface on HEIDENHAIN encoders differs in its pin assignment from the interface on Siemens motors with integrated absolute ECN/EQN rotary encoders. Special adapter cables are available.

## Encoder inputs for position control

Incremental and absolute linear, angle, or rotary encoders from HEIDENHAIN can be connected to encoder inputs of the TNC 128.

Channel inputs	Signal level/Interface <sup>1)</sup>	Input frequency <sup>1)</sup>
Incremental	$\sim 1 V_{PP}$	33 kHz/350 kHz
Absolute	EnDat 2.1 $\sim 1 V_{PP}$	– 33 kHz/350 kHz

<sup>1)</sup> Switchable

# Servo control

## Analog speed command interface

The position controller is integrated in the TNC 128. The motor speed controller and the current controller are located in the servo amplifier. The nominal speed command signal (= velocity) is sent by the TNC 128 to the servo amplifier through an analog  $\pm 10$  V interface (connection X8).

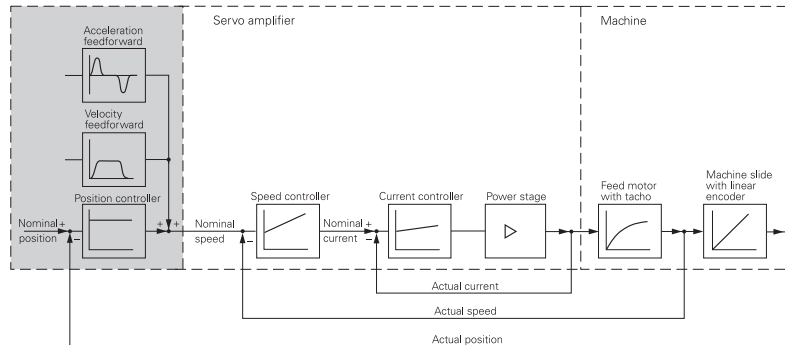

## Axis feedback control

The TNC 128 can be operated with following error or feedforward control.

## Operation with following error

The term "following error" denotes the distance between the momentary nominal position and the actual position of the axis. The velocity is calculated as follows:

$$v = k_v \cdot s_a$$

$v$  = Velocity  
 $k_v$  = Position loop gain  
 $s_a$  = Following error

## Operation with feedforward control

Feedforward means that a given velocity and acceleration are adapted to the machine. Together with the values calculated from the following error, this given velocity and acceleration becomes the nominal value. A much lower following error thereby manifests itself (in the range of only a few microns). Feedforward is adjustable from 0 % to 100 % by means of a machine parameter.

## Central drive

It is possible to use one common drive for several or all machine axes. The NC software allows the user to use the same nominal position value output for more than one axis.

The most important basic requirements for realizing a machine with central drive:

- Common drive package with an analog nominal position value input for all axes
- The PLC must treat the machine axes as clamping axes
- The PLC monitors the drive regarding movement in multiple axes and outputs an error message if necessary

## Axis clamping

The control loop can be opened through the PLC in order to clamp specific axes.

## Open-loop axes

One or more axes can be defined as open-loop axes (manual axes, counter axes). They have position encoders for determining and displaying the current position value, but no nominal-value outputs. The target position is reached manually (e.g., through mechanical handwheels). If an NC block with the open-loop axis is reached, a dialog window prompts the machine operator to move the axis to the nominal coordinates.

# Monitoring functions

## Description

During operation the control monitors the following details\*:

- Amplitude of the encoder signals
- Edge separation of the encoder signals
- Absolute position from encoders with distance-coded reference marks
- Current position (following error monitoring)
- Actual distance traversed (movement monitoring)
- Position deviation at standstill
- Checksum of safety-related functions
- Supply voltage
- Voltage of the backup battery
- Operating temperature of the MC and CPU
- Run time of the PLC program

In the event of hazardous errors, an emergency stop message is sent to the external electronics via the control-is-ready output, and the axes are brought to a stop. The correct connection of the TNC 128 in the machine's emergency stop loop is checked when the control system is switched on. In the event of an error, the control displays a message in plain language.

## Context-sensitive help

The HELP and ERR keys provide the user with context-sensitive help. This means that in the event of an error message, the control displays information on the cause of the error and proposes solutions. The machine tool builder can also use this function for PLC error messages.

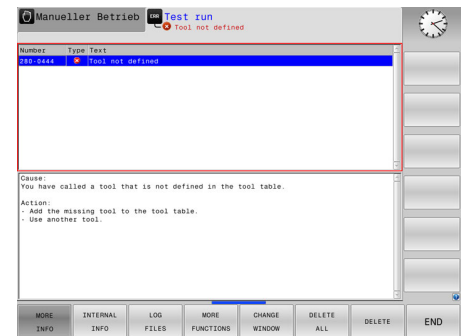

## KinematicsDesign (accessory)

KinematicsDesign is a PC program for creating adaptable kinematic configurations. It supports the following:

- Complete kinematic configurations
- Transfer of configuration files between control and PC
- Description of tool-carrier kinematics

Kinematic descriptions created for the iTNC 530 can also be transferred into kinematic descriptions for the TNC 640/620/320/128.

If KinematicsDesign is connected to a control online (operation is also possible with the programming station software), then machine movements can be simulated, and the axes are moved.

The visualization possibilities range from the pure depiction of the transformation chain and a wire model to a depiction of the entire working space.

\* No safety functions

# Error compensation

**Overview** The TNC 128 automatically compensates mechanical errors of the machine.

**Linear error** Linear error can be compensated over the entire travel range for each axis.

**Nonlinear error** The TNC 128 can compensate for ball-screw pitch errors and sag errors simultaneously. The compensation values are stored in a table. Nonlinear axis-error compensation also makes it possible to compensate for position-dependent backlash.

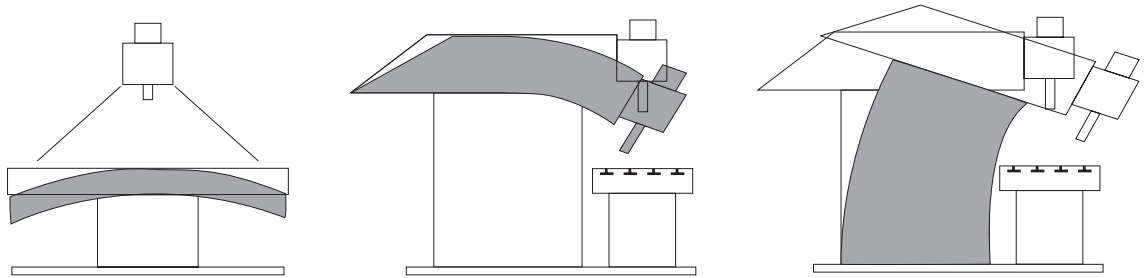

**Backlash** The play between table movement and rotary encoder movement during direction changes can be compensated in length measurements by spindle and rotary encoder. This backlash is outside the controlled system.

**Hysteresis** The hysteresis between table movement and motor movement is also compensated in direct length measurements. In this case, the hysteresis is within the controlled system.

**Static friction** At very low feed rates, high static friction can cause the slide to stop and start repeatedly for short periods. This is commonly known as stick-slip. The TNC 128 can compensate for this problematic behavior.

**Sliding friction** Sliding friction is compensated for by the speed controller of the TNC 128.

**Thermal expansion** To compensate for thermal expansion, the machine's expansion behavior must be known.

The temperature is ascertained by thermistors connected to the analog inputs of the TNC 128. The PLC evaluates the temperature information and passes the compensation value to the NC.



# Commissioning and diagnostic aids

## Overview

The TNC 128 provides comprehensive internal commissioning and diagnostic aids. It also includes highly effective PC software for diagnostics, optimization, and remote control.

## ConfigDesign (accessory)

PC software for configuring the machine parameters

- Stand-alone machine-parameter editor for the control; all support information, additional data, and input limits are shown for the parameters
- Configuration of machine parameters
- Comparison of parameters from different controls
- Importing of service files: easy testing of machine parameters in the field
- Rule-based creation and management of machine configurations for multiple controls (together with PLCdesign)

## Oscilloscope

The TNC 128 features an integrated oscilloscope. Both X/t and X/Y graphs are possible. The following characteristic curves can be recorded and stored in six channels:

- Actual value and nominal value of the axis feed rate
- Contouring feed rate
- Nominal and actual position
- Following error of the position controller
- Nominal values for speed, acceleration, and jerk
- Actual values for acceleration and jerk
- Nominal value of analog output
- Content of PLC operands
- Encoder signal (0°–A) and (90°–B)
- Nominal velocity value

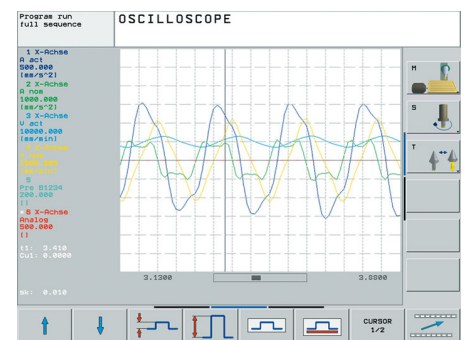

## Logic signals

Simultaneous graphic representation of the logic states of up to 16 operands (markers, words, inputs, outputs, counters, timers)

- Marker (M)
- Input (I)
- Output (O)
- Timer (T)
- Counter (C)
- IpoLogic (X)

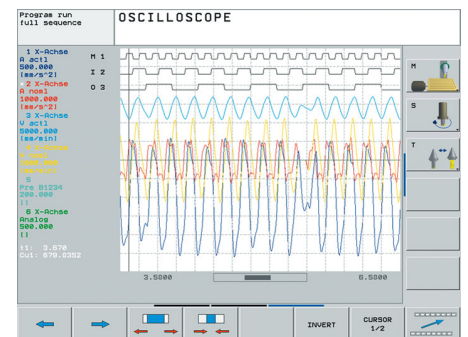

## Commissioning wizard

In order to simplify the adaptation of the axes and spindle, the commissioning wizard for analog axes guides you step-by-step through the commissioning of any axis parameter set. You can define the following machine parameters with the aid of the commissioning wizard:

- Ascertain the algebraic sign of the axis
- Ascertain the axis traverse direction
- Ascertain the velocity with 9 V analog voltage
- Ascertain the maximum acceleration of the axis
- Ascertain the  $k_v$  factor of the axis
- Ascertain acceleration feedforward control for the axis

<b>Online Monitor (OLM)</b>	<p>The online monitor is a component of the TNC 128 and is called over a code number. It supports commissioning and diagnosis of control components through the following:</p> <ul style="list-style-type: none"> <li>• Display of control-internal variables for axes and channels</li> <li>• Display of controller-internal variables (if a CC is present)</li> <li>• Display of hardware signal states</li> <li>• Various trace functions</li> <li>• Activation of spindle commands</li> <li>• Enabling of control-internal debug outputs</li> </ul>									
<b>TNCscope (accessory)</b>	<p>PC software for transferring the oscilloscope files to a PC. With TNCscope you can record and save up to 16 channels simultaneously.</p> <p><b>Note:</b> The trace files are saved in the TNCscope data format.</p>									
<b>API DATA</b>	<p>The API DATA function enables the control to display the states or contents of the symbolic API markers and API double words. This function requires that your PLC program use the symbolic memory interface.</p> <p><b>Note:</b> The API DATA function does not provide usable display values with the iTNC 530-compatible memory interface (API 1.0)</p>									
<b>Table function</b>	<p>The current conditions of the markers, words, inputs, outputs, counters, and timers are displayed in tables. The conditions can be changed through the keyboard.</p>									
<b>Trace function</b>	<p>The current content of the operands and the accumulators is shown in the statement list in each line in hexadecimal or decimal code. The active lines of the statement list are marked.</p>									
<b>Log</b>	<p>For the purpose of error diagnostics, all error messages and keystrokes are recorded in a log. The entries can be read using the <b>PLCdesign</b> or <b>TNCremo</b> software for PCs.</p>									
<b>TeleService (accessory)</b>	<p>PC software for remote diagnostics, remote monitoring, and remote operation of the control. For more information, please ask for the <i>Remote Diagnosis with TeleService</i> Technical Information sheet.</p>									
	<table border="0"> <tr> <td><b>Single station license</b></td> <td></td> <td>ID 340449-xx</td> </tr> <tr> <td><b>Network license</b></td> <td>For 14 workstations</td> <td>ID 340454-xx</td> </tr> <tr> <td></td> <td>For 20 workstations</td> <td>ID 340455-xx</td> </tr> </table>	<b>Single station license</b>		ID 340449-xx	<b>Network license</b>	For 14 workstations	ID 340454-xx		For 20 workstations	ID 340455-xx
<b>Single station license</b>		ID 340449-xx								
<b>Network license</b>	For 14 workstations	ID 340454-xx								
	For 20 workstations	ID 340455-xx								

**TNCtest**

Acceptance tests on machine tools with external or integrated functional safety (FS) must be conducted reproducibly and verifiably.

The TNCtest and TestDesign program packages can be used to plan and perform acceptance tests for machine tools with HEIDENHAIN controls. The acceptance tests are planned with TestDesign and run with TNCtest.

The TNCtest programs are designed to provide support during acceptance testing, provide required information, and perform automatic configurations, as well as record data and evaluate the data semiautomatically. A tester must evaluate manually whether a test case passed or failed.

**TNCanalyzer**

The TNCanalyzer application from HEIDENHAIN provides for simple and intuitive evaluation of service files and log files.

Function:

- Loading of service and log files
- Analysis of temporal sequences and static states
- Filters and search functions
- Data export (HELogger, CSV and JSON formats)
- Definition of application-specific analysis profiles
- Preconfigured analysis profiles
- Graphic display of signals via TNCscope
- Interaction with other tools that are intended for the display of special sections of the service file

# Integrated PLC

## Overview

The PLC program is created by the machine manufacturer either at the control or with the PLC development software **PLCdesign** (accessory). Machine-specific functions are activated and monitored via the PLC inputs/outputs. The number of PLC inputs/outputs required depends on the complexity of the machine.

## PLC expansion

If the PLC inputs/outputs of the TNC 128 do not suffice, you can connect the external PLC input/output system PL 510.

## Rated operating current

MC main computer: 0.15 A per output  
 PL 510: see *PL 510 PLC input/output systems*

## PLC programming

Format	Statement list
Memory	350 MB
Cycle time	9 ms to 30 ms (adjustable)
Command set	<ul style="list-style-type: none"> <li>• Bit, byte, and word commands</li> <li>• Logical operations</li> <li>• Arithmetic commands</li> <li>• Comparisons</li> <li>• Bracketed terms</li> <li>• Jump commands</li> <li>• Subprograms</li> <li>• Stack operations</li> <li>• Submit programs</li> <li>• Timers</li> <li>• Counters</li> <li>• Comments</li> <li>• PLC modules</li> <li>• Strings</li> </ul>

## PLC window

The TNC 128 can display PLC error messages in the dialog line during operation.

## Small PLC window

The TNC 128 can show additional PLC messages and bar diagrams in the small PLC window.

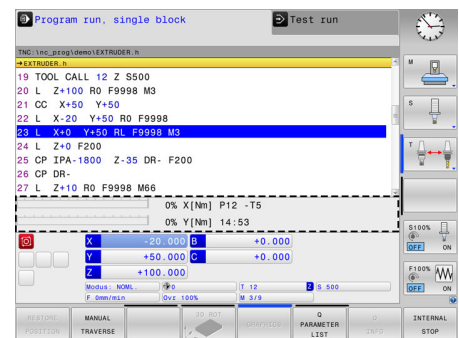

Small PLC window

## PLC soft keys

The machine manufacturer can display his own PLC soft keys in the vertical soft-key row on the screen.

**PLC positioning**

All closed-loop axes can also be positioned via the PLC. PLC positioning of the NC axes cannot be superimposed on NC positioning.

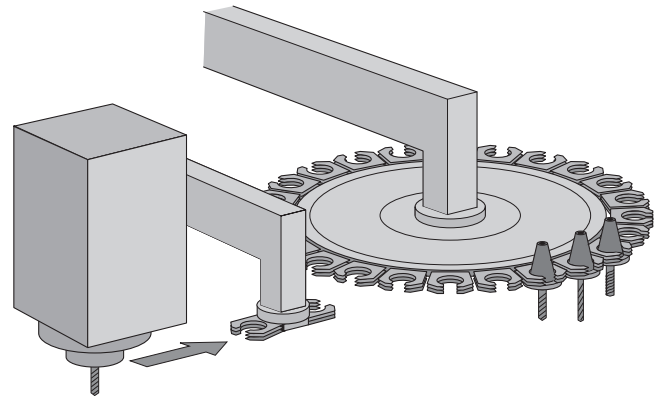
**PLC axes**

Axes can be defined as PLC axes. They are programmed by means of M functions or OEM cycles. The PLC axes are positioned independently of the NC axes.

**PLCdesign  
(accessory)**

PC software for PLC program development. The PC program **PLCdesign** can be used for easy creation of PLC programs. Extensive examples of PLC programs are included with the product.

Functions:

- Easy-to-use text editor
- Menu-guided operation
- Programming of symbolic operands
- Modular programming techniques
- "Compiling" and "linking" of PLC source files
- Operand commenting, creation of the documentation file
- Comprehensive help system
- Data transfer between the PC and control
- Creation of PLC soft keys

## Python OEM Process (option 46)

The Python OEM Process option is an effective tool for the machine tool builder to use an object-oriented high-level programming language in the control (PLC). Python is an easy-to-learn script language that supports the use of all necessary high-level language elements.

Python OEM Process can be used universally for machine functions and complex calculations, as well as to display special user interfaces. User-specific or machine-specific solutions can be efficiently implemented. Numerous libraries on the basis of Python and GTK are available, regardless of whether you want to create special algorithms for special functions, or separate solutions such as an interface for machine maintenance software.

The applications you create can be included via the PLC in the familiar PLC windows, or they can be displayed in separate free windows that can be expanded to the control's full screen size.

Simple Python scripts (e.g., for display masks) can also be executed without enabling Python OEM Process (software option 46). For this function, 10 MB of dedicated memory is reserved. For more information, refer to the *Python in HEIDENHAIN Controls* Technical Manual.

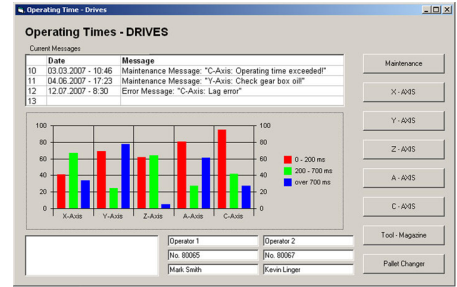

## **PLC basic program**

The PLC basic program serves as a basis for adapting the control to the requirements of the respective machine. It can be downloaded from the Internet.

These essential functions are covered by the PLC basic program:

### **Axes**

- Control of analog
- Axes with clamping mode
- Axes with central drive
- Axes with Hirth grid
- Synchronized axes
- Reference run, reference end position
- Axis lubrication

### **Spindles**

- Control and orientation of the spindles
- Spindle clamping
- Alternative double-spindle operation
- Parallel spindle operation
- Conventional 2-stage gear system
- Wye/delta connection switchover (static, dynamic)

### **Tool changers**

- Manual tool changer
- Tool changer with pick-up system
- Tool changer with dual gripper
- Tool changer with positively driven gripper
- Rotating tool magazine with closed-loop axis
- Rotating tool magazine with controlled axis
- Servicing functions for the tool changer
- Python tool management

### **Safety functions**

- Emergency stop test (EN 13849-1)
- Brake test (EN 13849-1)
- Repeated switch-on test for new generation of handwheel

### **General functions**

- Feed rate control
- Control of the coolant system (internal, external, air)
- Temperature compensation
- Activation of tool-specific torque monitoring
- Hydraulic control
- Chip conveyor
- Indexing fixture
- Touch probes
- PLC support for handwheels
- Control of doors
- Handling of M functions
- PLC log
- Display and management of PLC error messages
- Diagnostics screen (Python)
- Python example applications
- Status display in the small PLC window

# Interfacing to the machine

## OEM cycles

The machine tool builder can create and store his own cycles for recurring machining tasks. These OEM cycles are used in the same way as standard HEIDENHAIN cycles.

## CycleDesign (accessory)

The soft-key structure for the cycles is managed using the **CycleDesign** PC program. In addition, CycleDesign can be used to store help graphics and soft keys in BMP format in the TNC. Graphic files can be compressed to ZIP format to reduce the amount of memory used.

## Tool management

With integral PLC, the tool changer is moved either via proximity switch or as a controlled axis. Tool management including tool life monitoring and replacement tool monitoring is carried out by the TNC 128.

## Tool calibration

Tool touch probes can be measured and checked with the **TT** tool touch probe system (accessory). Standard cycles for automatic tool measurement are available in the control. The control calculates the probing feed rate and the optimal spindle speed. The measured data are stored in a tool table.



## Touch-probe configuration

All touch-probe data can be configured conveniently through a table. All HEIDENHAIN touch probe systems are preconfigured and can be selected through a drop-down menu.

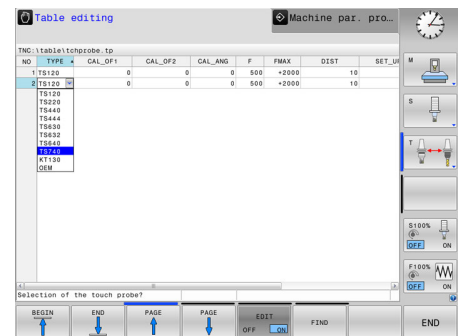



# Data transfer and communication

## Data interfaces

<b>Overview</b>	The TNC 128 is connected to PCs, networks, and other data storage devices via data interfaces.	
<b>Ethernet</b>	The TNC 128 can be interconnected via the Ethernet interface. For connection to the data network, the control features a 1000BASE-T (twisted pair Ethernet) connection.  Maximum transmission distance: Unshielded: 100 m Shielded: 400 m	
Protocol	The TNC 128 communicates using the TCP/IP protocol.	
Network connection	<ul style="list-style-type: none"><li>• NFS file server</li><li>• Windows networks (SMB)</li></ul>	
Data transmission speed	Approx. 400 to 800 Mbps (depending on file type and network utilization)	
<b>RS-232-C/V.24</b>	Data interface according to DIN 66 020 or EIA standard RS-232-C. Maximum transmission distance: 20 m	
Data transmission speed	115 200; 57 600; 38 400; 19 200; 9600; 4800; 2400; 1200; 600; 300; 150; 110 bps	
Protocols	The TNC 128 can transfer data using various protocols.	
Standard data transmission	The data is transferred character by character. The number of data bits, stop bits, the handshake, and character parity must be set by the user.	
Blockwise data transfer	The data is transferred blockwise. A block check character (BCC) is used for data backup. This method improves data security.	
LSV2	Bidirectional transfer of commands and data as per DIN 66 019. The data is divided into telegrams (blocks) and transmitted.	
<b>USB</b>	The TNC 128 features USB ports for the connection of standard USB devices, such as a mouse, drives, etc. On the back panel of the MC 128 there are two USB 3.0 ports. The USB ports are rated for a maximum of 0.5 A.	
<b>USB cables</b>	Cable length of up 5 m	ID 354770-xx
	Cable length of 6 m to 30 m with integrated amplifier; limited to USB 1.1.	ID 624775-xx

## USB hub

If you need further USB ports or if the supply current is not sufficient, a USB hub is required. The USB hub from HEIDENHAIN offers four free USB 2.0 ports.

### USB hub

ID 582884-xx

Power supply: DC 24 V/max. 300 mA



## Cover

The USB hub can be installed in the operating panel in such a way that two USB ports can be accessed from the outside. An optionally available cover cap can be used to protect the ports from contamination.

### Cover

ID 508921-xx

## Software for data transfer

We recommend using HEIDENHAIN software to transfer files between the TNC 128 and a PC.

### TNCremo (accessory)

This PC software package helps the user to transfer data from the PC to the control. The software transfers data blockwise with block check characters (BCC).

Functions:

- Data transfer (also blockwise)
- Remote control (only serial)
- File management and data backup of the control
- Reading out the log
- Print-out of screen contents
- Text editor
- Managing more than one machine

### TNCremoPlus (accessory)

In addition to the features already familiar from TNCremo, TNCremoPlus can also transfer the current content of the control's screen to the PC (live screen). This makes it very simple to monitor the machine.

Additional functions:

- Interrogation of DNC data (NC uptime, machine uptime, machine running time, spindle running time, pending errors, data from the data servers—e.g., symbolic PLC operands)
- Targeted overwriting of tool data using the values of a tool presetter

### TNCremoPlus

ID 340447-xx

# DNC applications

## Overview

The development environments on Windows operating systems are particularly well suited as flexible platforms for application development in order to come to terms with the increasingly complex requirements of the machine's environment. The flexibility of the PC software and the large selection of ready-to-use software components and standard tools in the development environment enable you to develop PC applications of great use to your customers in a very short time, for example:

- Error reporting systems that, for example, send the customer a text message to his cell phone reporting problems on the currently running machining process
- Standard or customer-specific PC software that decidedly increases process reliability and equipment availability
- Software solutions controlling the processes of manufacturing systems
- Information exchange with job management software

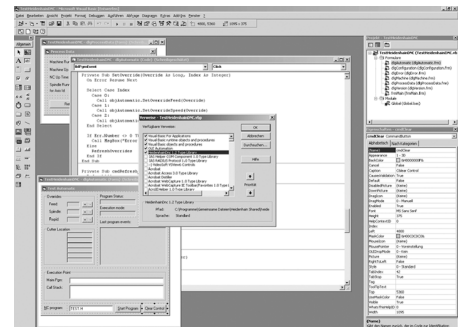
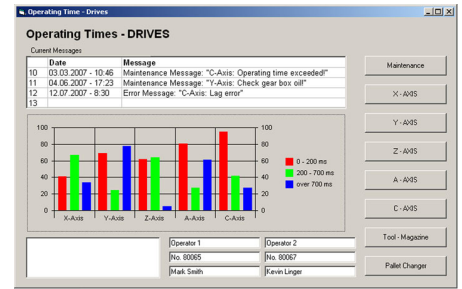

## HEIDENHAIN DNC (option 18)

The HEIDENHAIN DNC software interface is an attractive communication platform for this purpose. It provides all the data and configuration capabilities needed for these processes so that an external PC application can evaluate data from the control and, if required, influence the manufacturing process.

## RemoTools SDK (accessory)

To enable you to use HEIDENHAIN DNC effectively, HEIDENHAIN offers the RemoTools SDK development package. It contains the COM component and the ActiveX control for integration of the DNC functions in development environments.

### RemoTools SDK

ID 340442-xx

For more information, refer to the *HEIDENHAIN DNC* brochure.

# Mounting information

## Clearances and mounting

### Proper minimum clearance

When mounting the control components, please observe proper minimum clearances and space requirements, as well as length and position of the connecting cables.

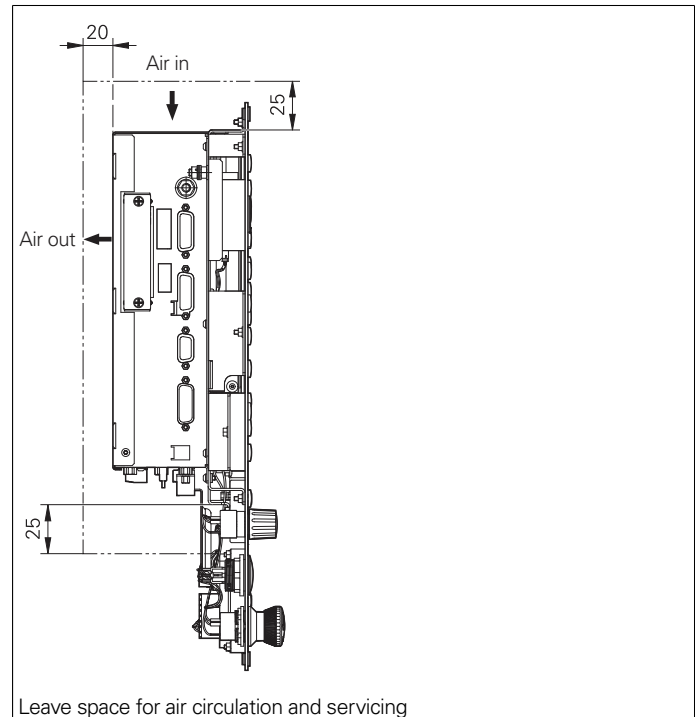

### Mounting and electrical installation

Observe the following points during mounting and electrical connection:

- National regulations for low-voltage installations at the operating site of the machine or components
- National regulations regarding interference and noise immunity at the operating site of the machine or components
- National regulations regarding electrical safety and operating conditions at the operating site of the machine or components
- Specifications for the installation position
- Specifications of the Technical Manual

### Degrees of protection

The following components fulfill the requirements for IP54 (dust protection and splash-proof protection):

- TNC 128 (when properly installed)
- Machine operating panel (when properly installed)
- Handwheel

### Electromagnetic compatibility

Protect your equipment from interference by observing the rules and recommendations specified in the Technical Manual.

Intended place of operation

This unit fulfills the requirements for EN 50370-1 and is intended for operation in industrially zoned areas.

Likely sources of interference

Interference is produced by capacitive and inductive coupling into electrical conductors or into device connections, caused by, e.g.:

- Strong magnetic fields from transformers or electric motors
- Relays, contactors, and solenoid valves
- High-frequency equipment, pulse equipment, and stray magnetic fields from switch-mode power supplies
- Power lines and leads to the above equipment

Protective  
measures

- Ensure that the MC, CC, and signal lines are at least 20 cm away from interfering devices
- Ensure that the MC, CC, and signal lines are at least 10 cm away from cables carrying interfering signals
- Shielding according to EN 50178
- Use equipotential bonding lines according to the grounding plan. Please refer to the Technical Manual of your control
- Use only genuine HEIDENHAIN cables and connecting elements

**Installation  
elevation**

The maximum altitude for installation of HEIDENHAIN control components (MC, CC, PLB, MB, TE, BF, IPC, etc.) is 3000 m above sea level.

# Overall dimensions

## Main computer

MC 128

mm  
  
 Tolerancing ISO 8015  
 ISO 2768 - m H  
 < 6 mm: ±0.2 mm

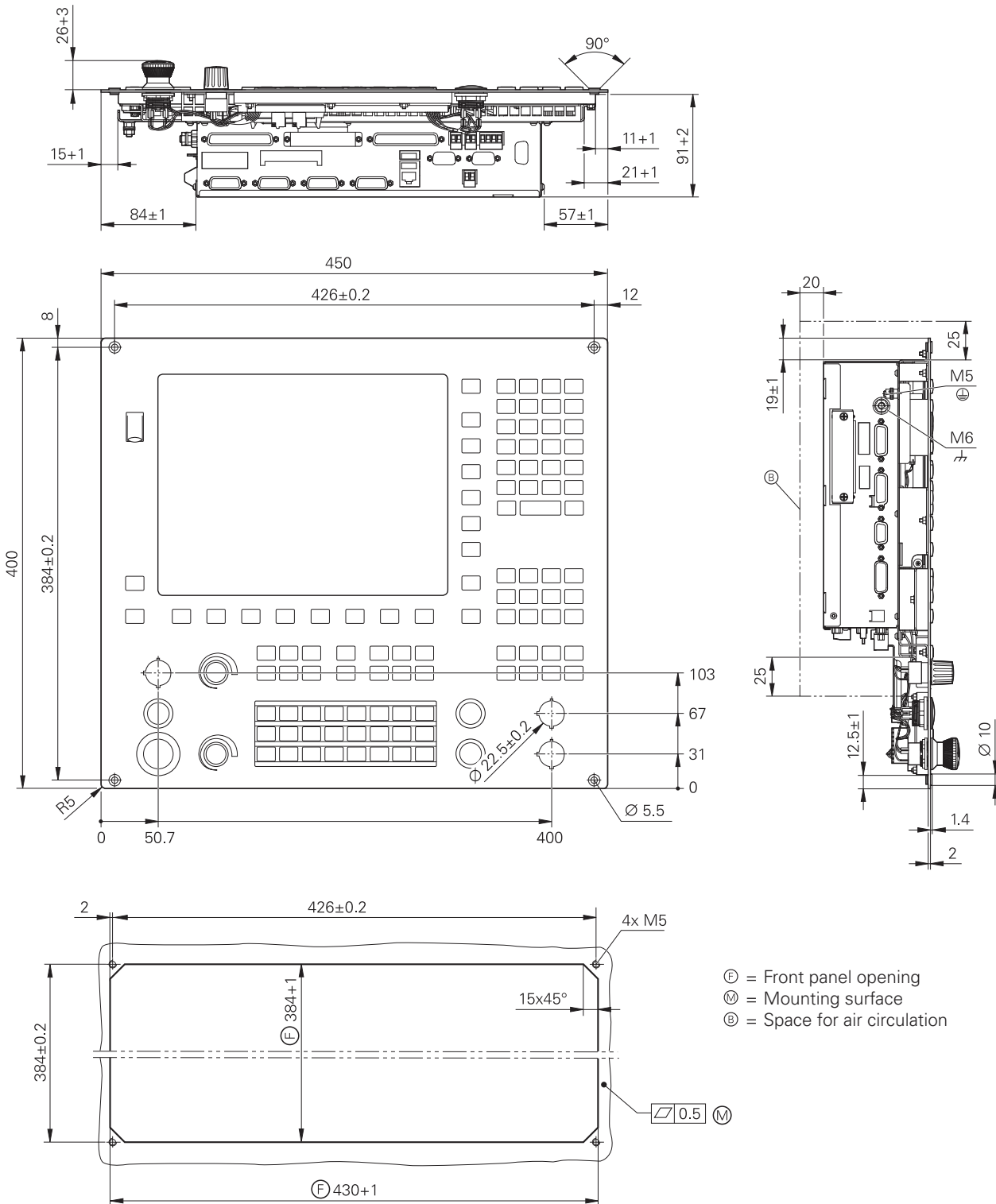

# PLC inputs and outputs

## PL 510

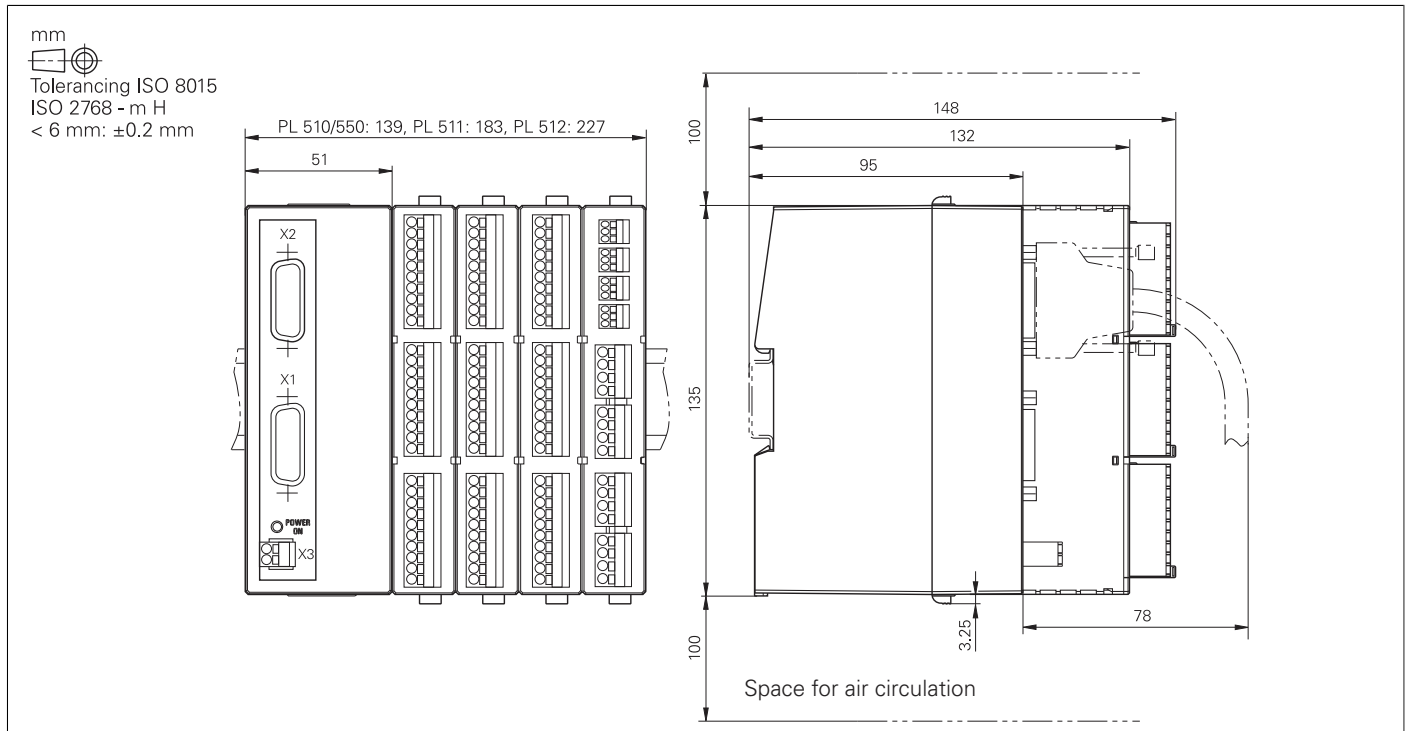

# Electronic handwheels

## HR 510

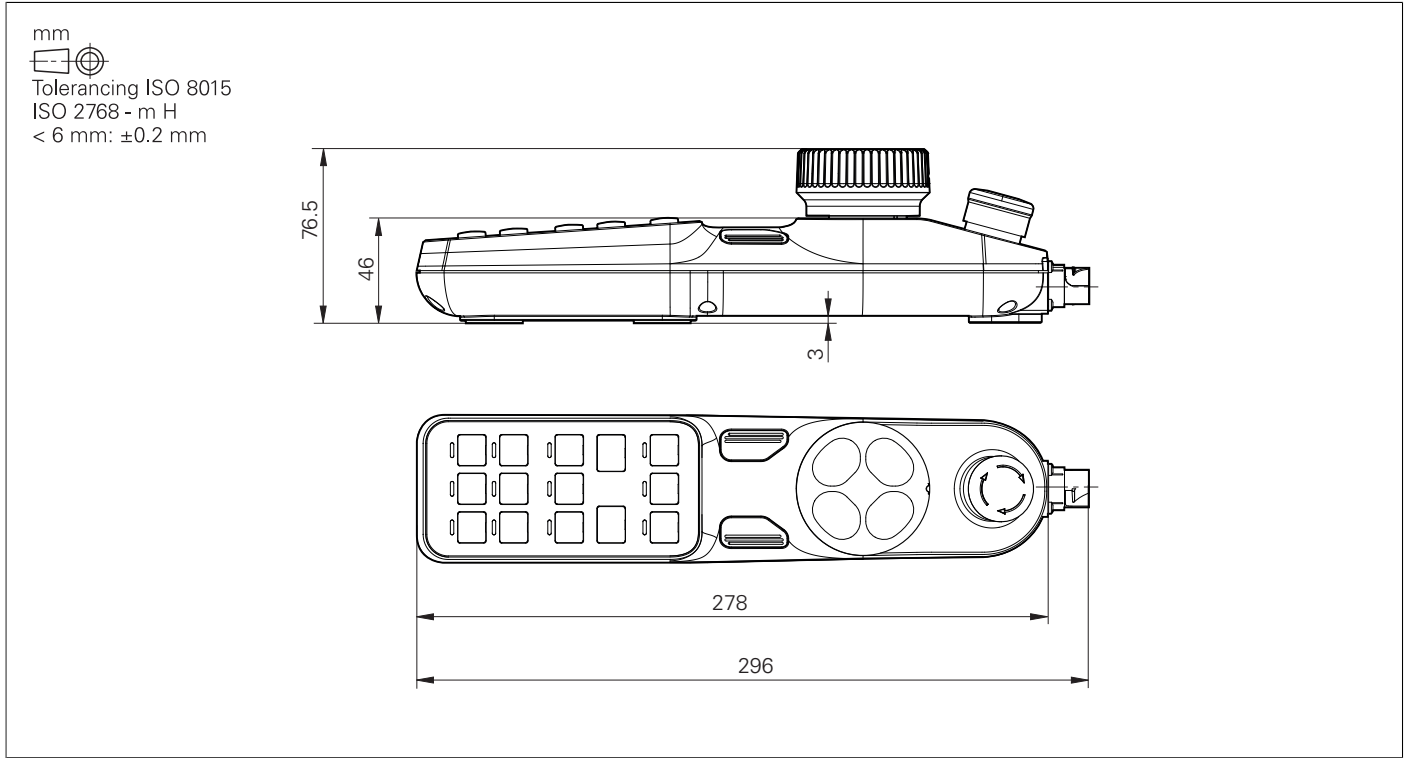

## HR 520, HR 520 FS

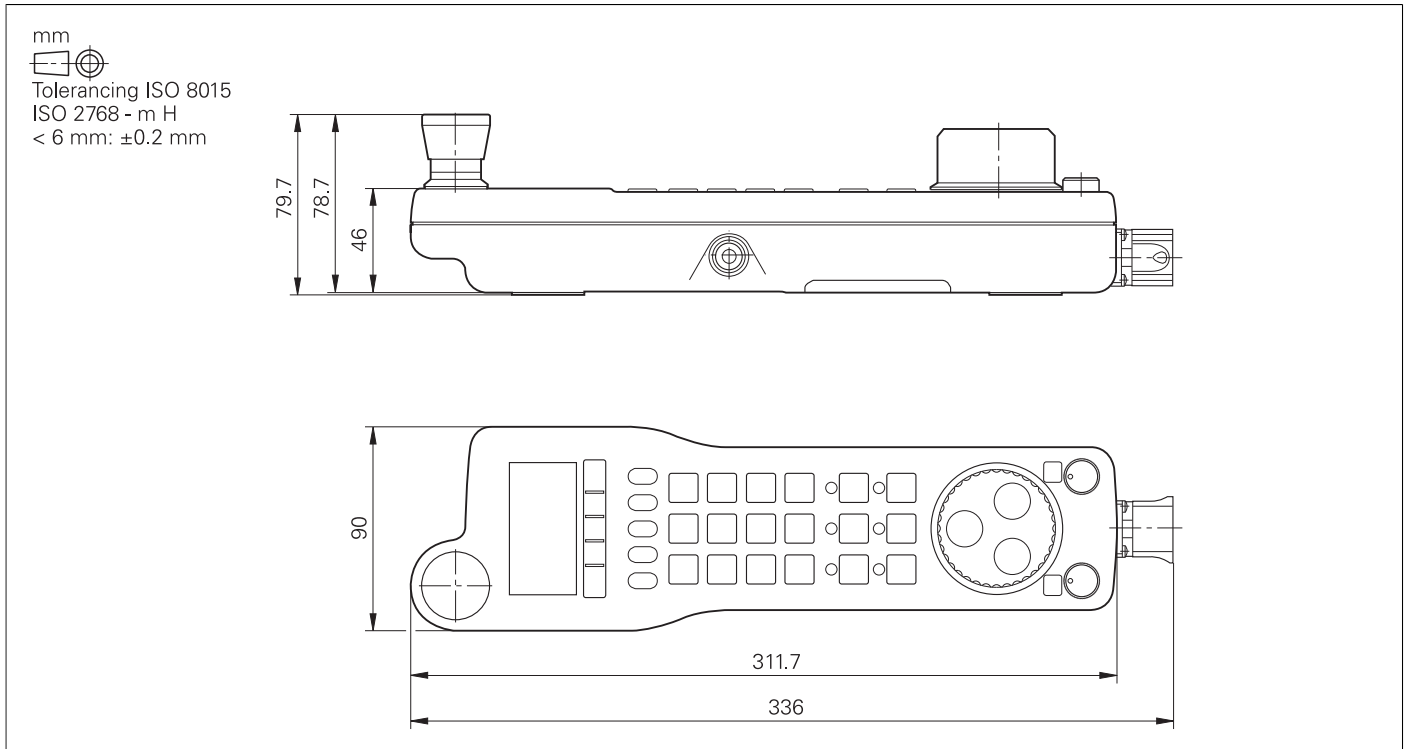



**Holder for HR 520, HR 520 FS**

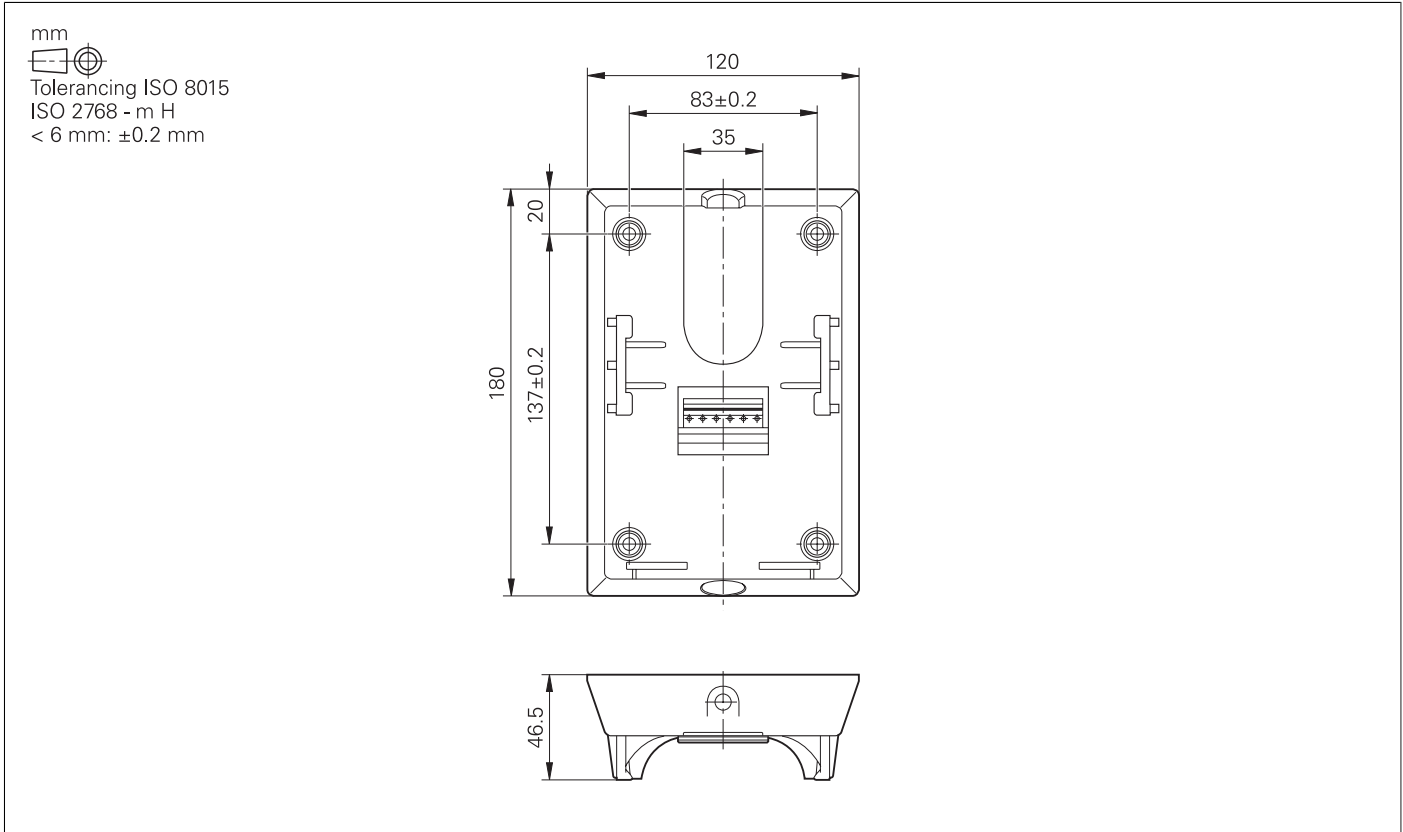

**HR 550 FS**

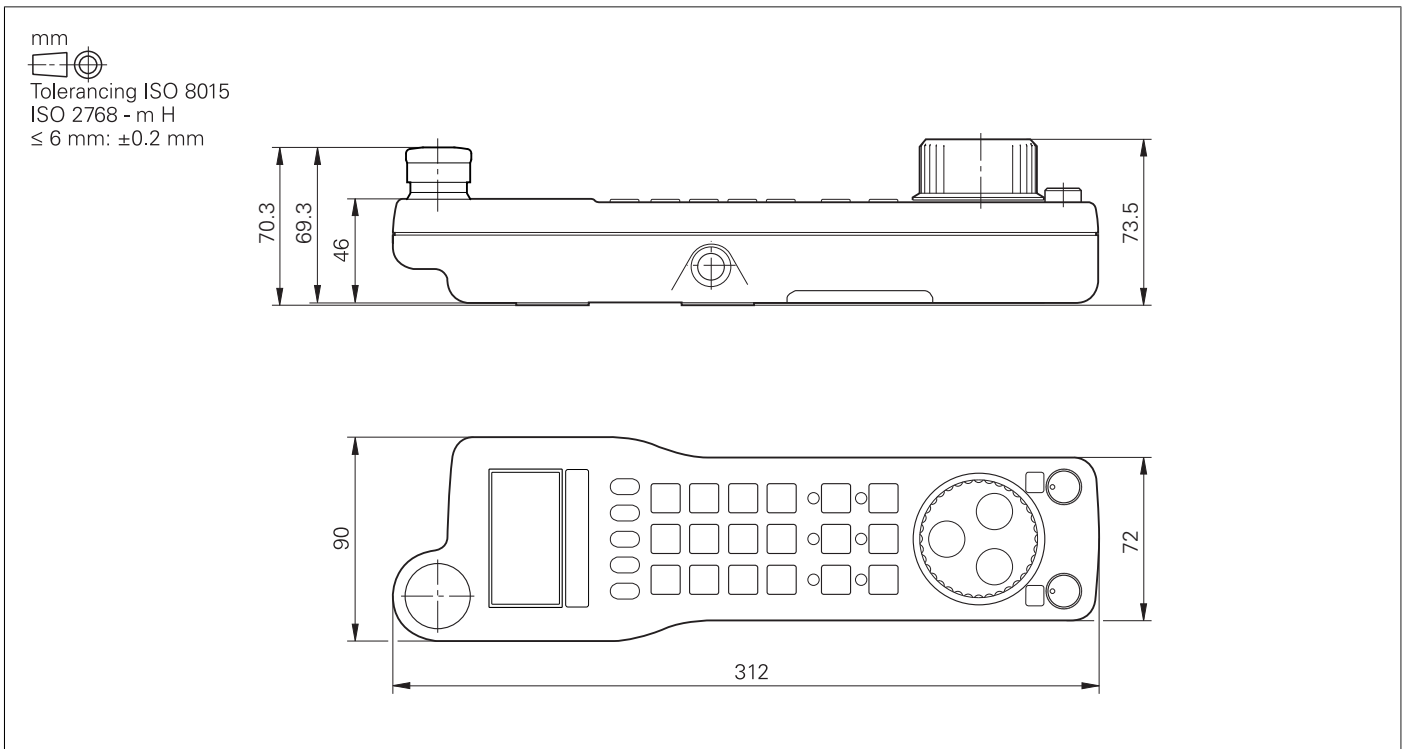

# HRA 551 FS

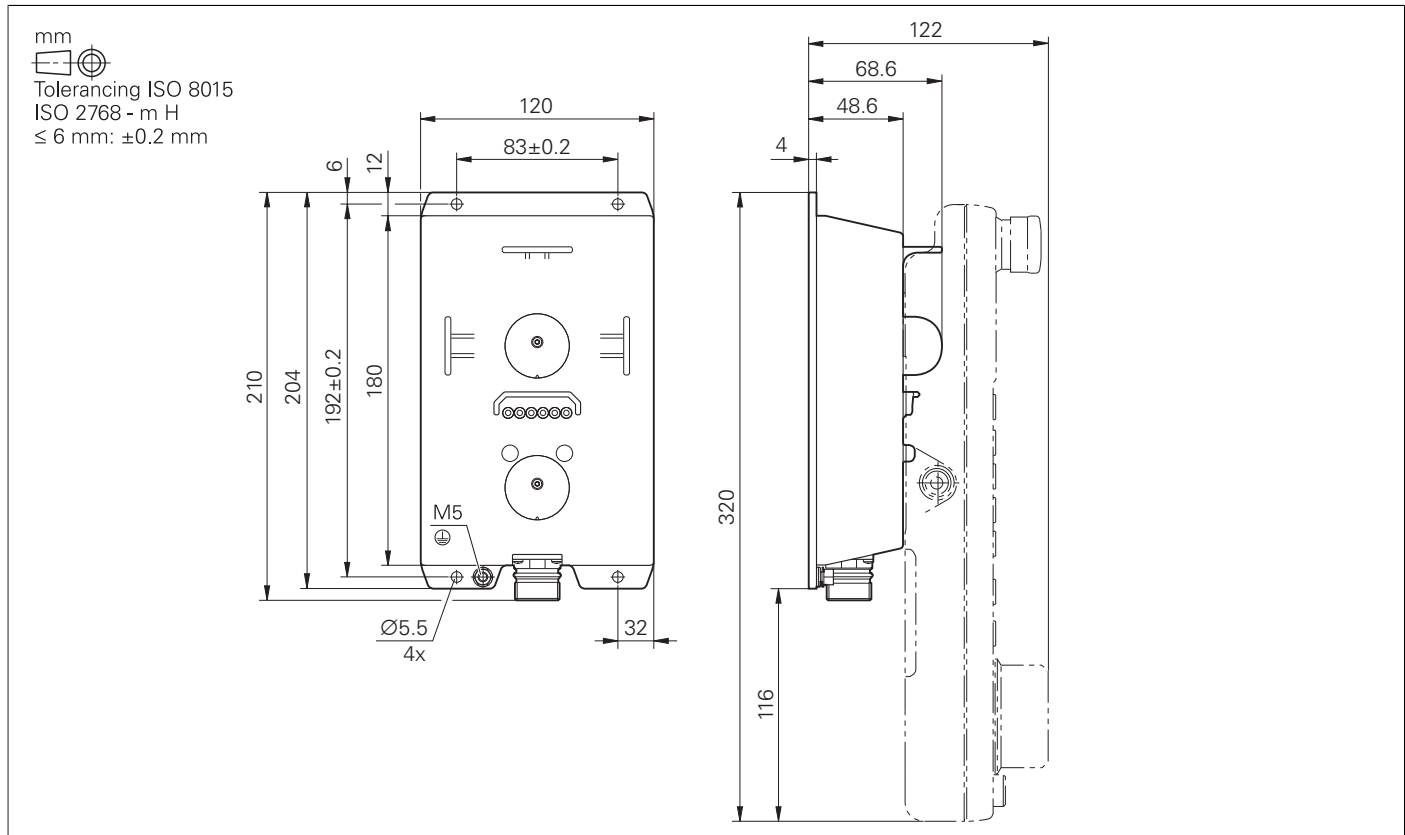

**HR 130, HR 150 with control knob**

mm



Tolerancing ISO 8015  
 ISO 2768 - m H  
 < 6 mm: ±0.2 mm

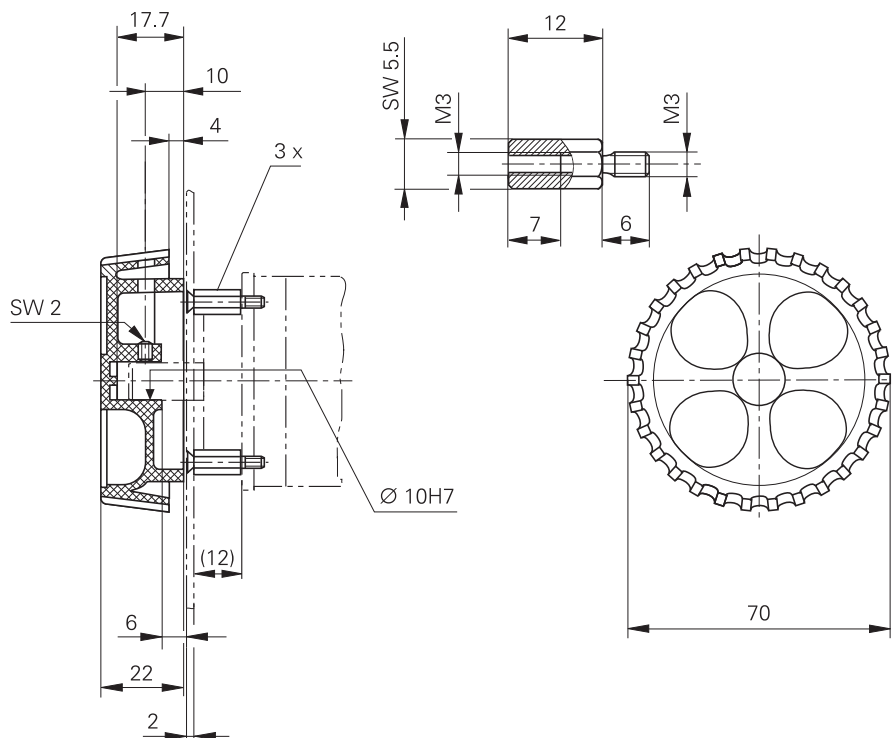
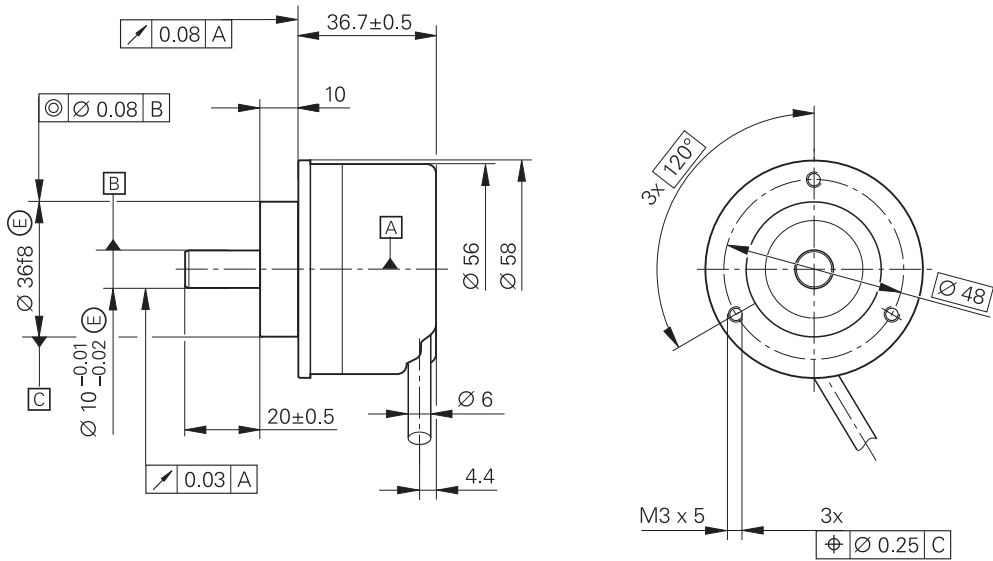

# HRA 110

mm  
Tolerancing ISO 8015  
ISO 2768 - m H  
< 6 mm: ±0.2 mm

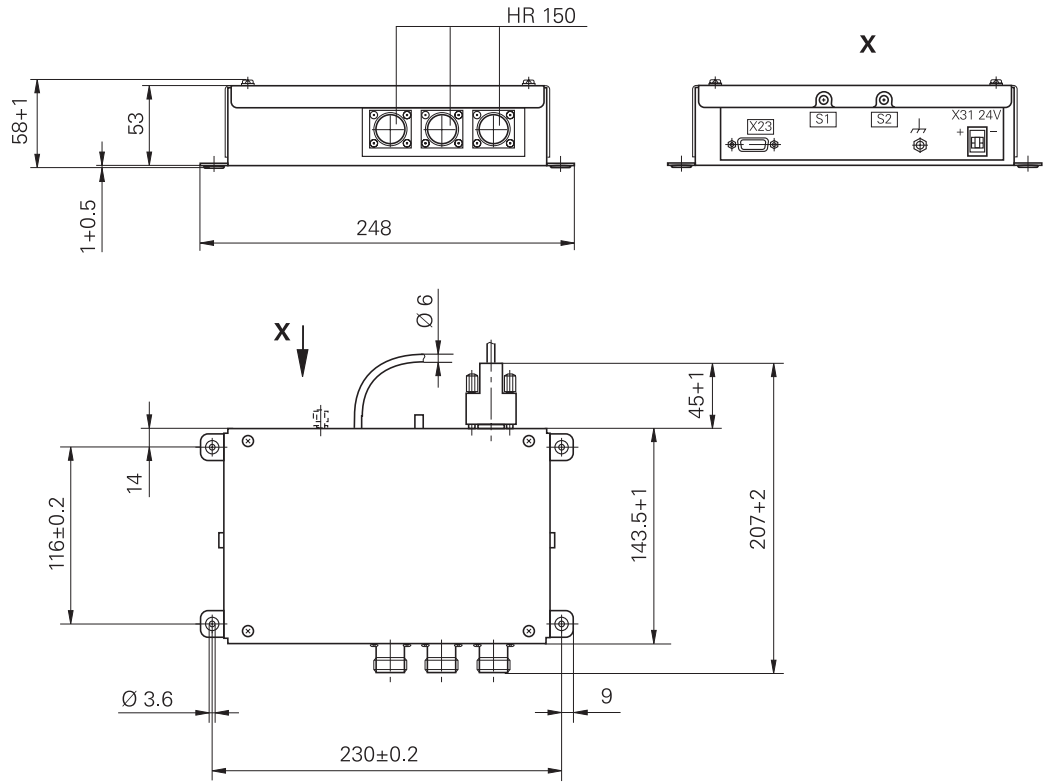

**Adapter cable for handwheels (straight)**

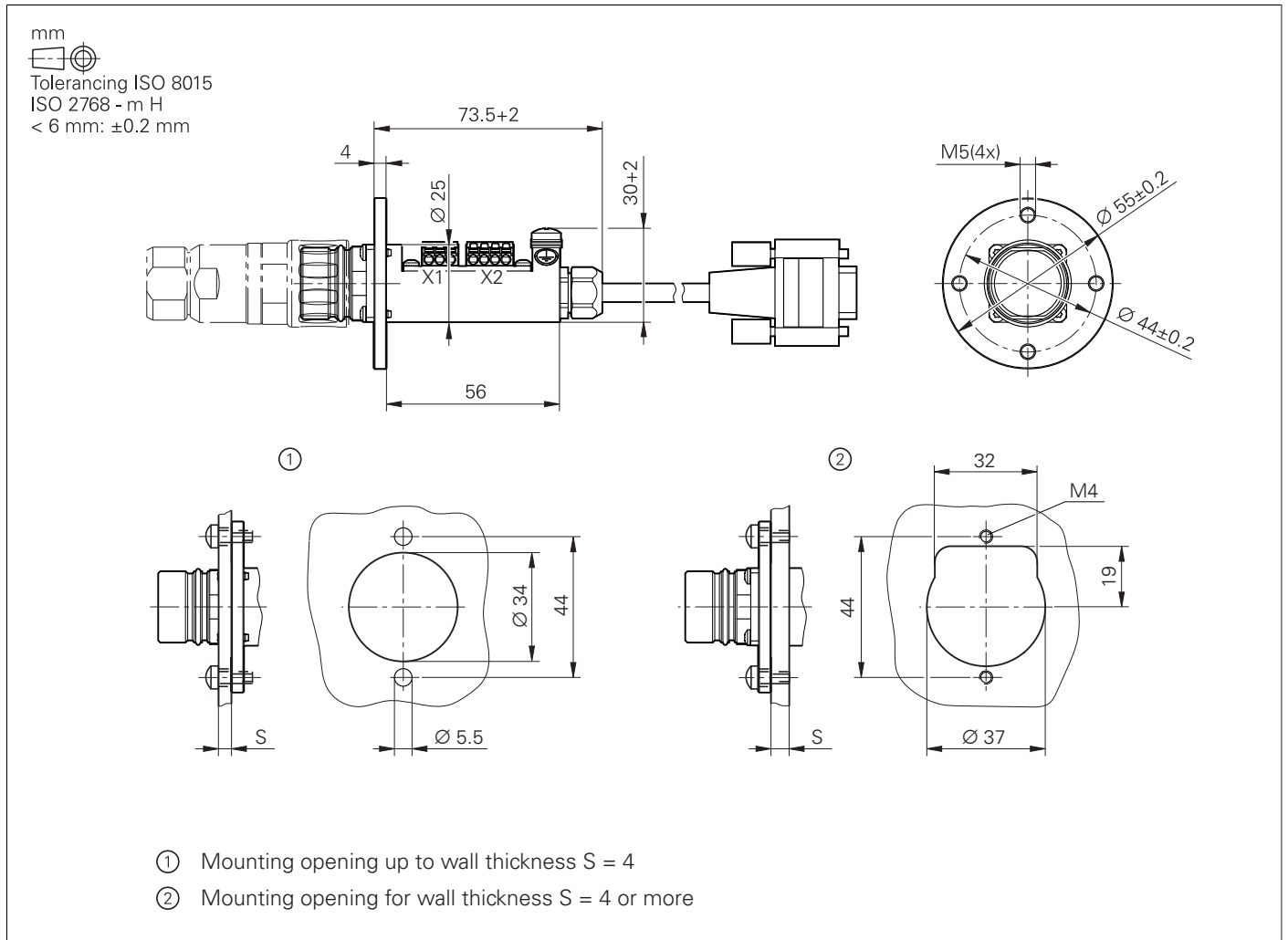

HR/HRA adapter cable to MC (straight connector)

**Adapter cable for handwheels (angled)**

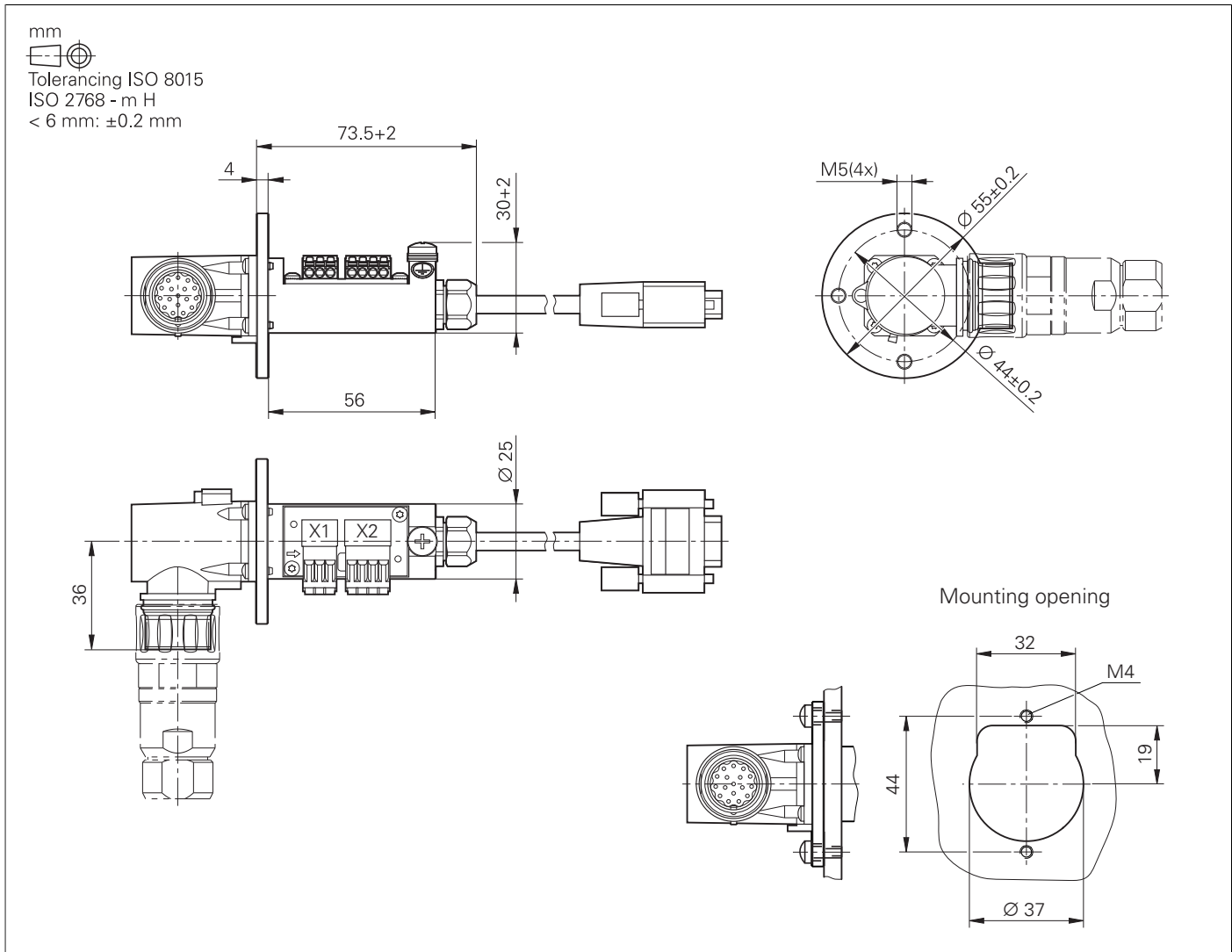

**Adapter cable for HR/HRA to MC (angled connector)**

# Interface accessories

## Line-drop compensator for encoders with EnDat interface

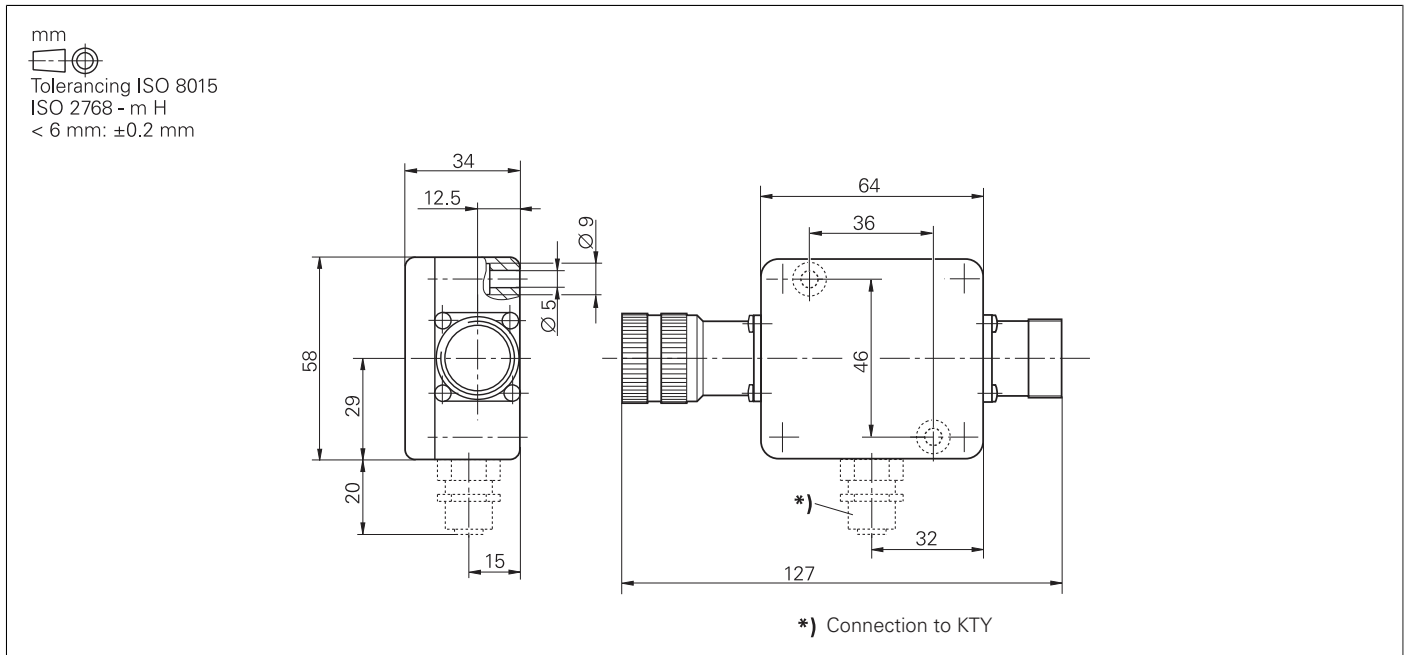

## USB hub

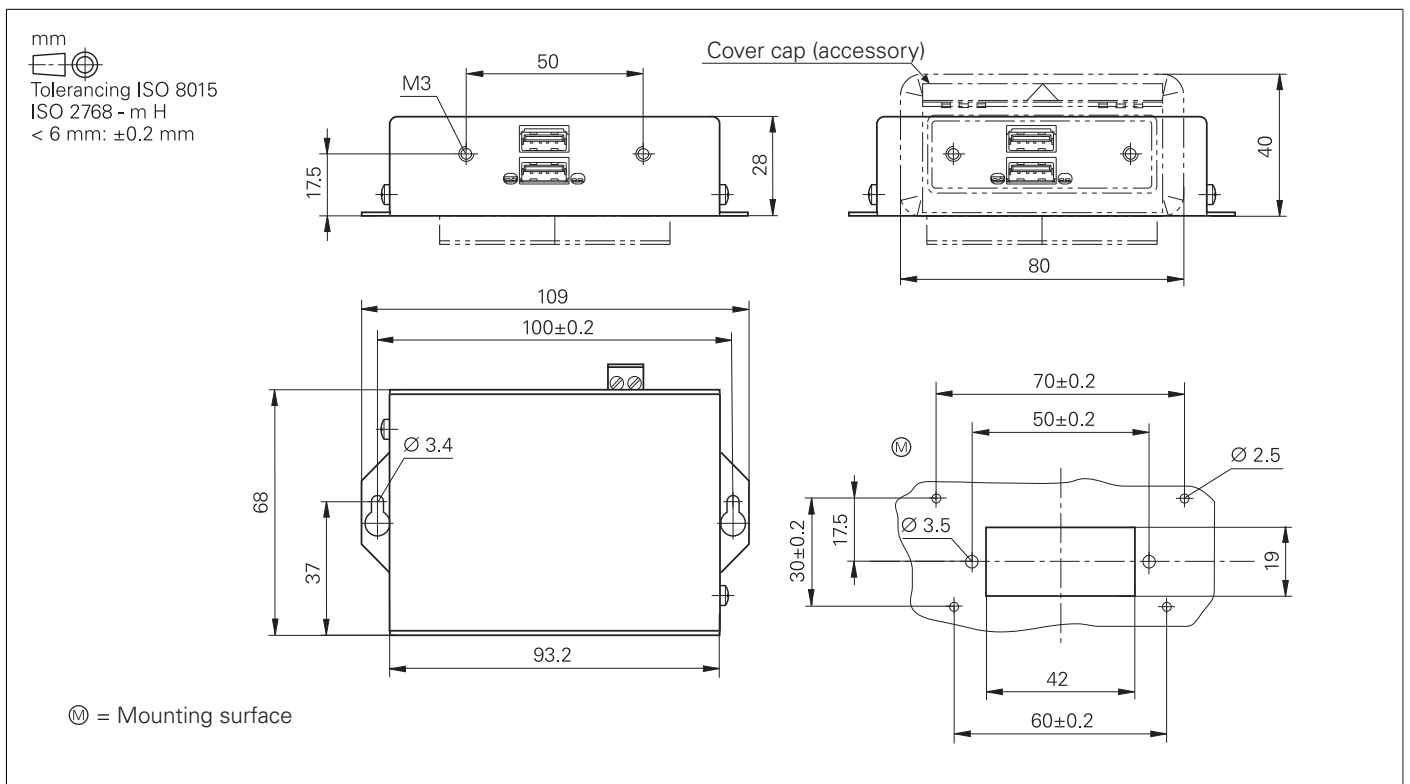

## USB extension cable with hubs

mm  
Tolerancing ISO 8015  
ISO 2768 - m H  
< 6 mm:  $\pm 0.2$  mm

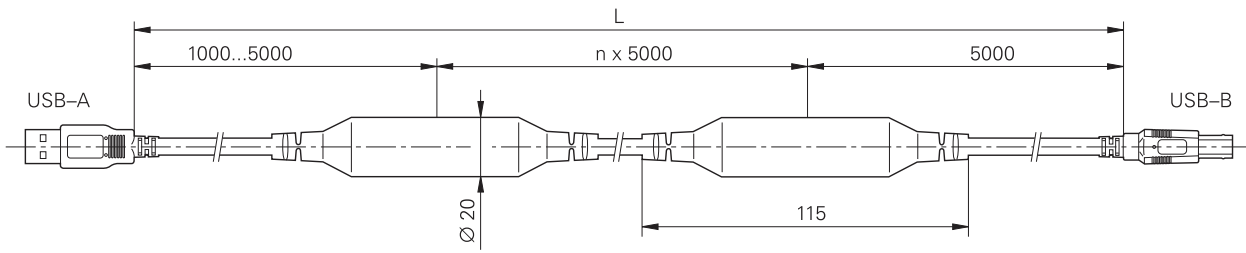

n = 0 ... 4  
L = Ordering length



# General information

## Documentation

<b>Technical documentation</b>	<ul style="list-style-type: none"><li>• <b>TNC 128</b> Technical Manual</li><li>• <b>TS 260</b> Mounting Instructions</li><li>• <b>TT 160</b> Mounting Instructions</li></ul>	ID 1109223-xx; in PDF format on HESIS-Web including FilebaseID ID 808652-9x ID 808654-xx
<b>User documentation</b>	<b>TNC 128</b> <ul style="list-style-type: none"><li>• <b>HEIDENHAIN Klartext Programming</b> User's Manual</li></ul> <b>Miscellaneous</b> <ul style="list-style-type: none"><li>• <b>TNCremo</b> User's Manual</li><li>• <b>TNCremoPlus</b> User's Manual</li><li>• <b>PLCdesign</b> User's Manual</li><li>• <b>CycleDesign</b> User's Manual</li><li>• <b>KinematicsDesign</b> User's Manual</li></ul>	ID 819494-xx  As integrated help As integrated help As integrated help As integrated help As integrated help
<b>Other documentation</b>	<ul style="list-style-type: none"><li>• <b>TNC 128</b> brochure</li><li>• <b>Touch Probes</b> brochure</li><li>• <b>RemoTools SDK virtualTNC</b> brochure</li><li>• <b>Remote Diagnosis with TeleService</b> Product Overview</li><li>• <b>Touch Probes</b> DVD</li><li>• <b>HR 550FS</b> Product Information document</li></ul>	ID 827137-xx ID 1113984-xx ID 628968-xx ID 348236-xx ID 344353-xx PDF
<b>Safety parameters</b>	For HEIDENHAIN products (such as control components, encoders, or motors), the safety characteristics (such as failure rates or statements on fault exclusion) are available on product-specific request from your HEIDENHAIN contact person.	
<b>Basic circuit diagram</b>	More information on basic circuit diagrams can be requested from your HEIDENHAIN contact person.	

# Service and training

**Technical support** HEIDENHAIN offers the machine manufacturer technical support to optimize the adaptation of the control to the machine, including on-site support.

**Exchange control** In the event of a malfunction, HEIDENHAIN guarantees the timely shipment of an exchange control (usually within 24 hours in Europe).

**Helpline** Our service engineers are available by phone if you have any questions regarding adaptation or malfunctions:

- NC support** +49 8669 31-3101  
E-mail: [service.nc-support@heidenhain.de](mailto:service.nc-support@heidenhain.de)
- PLC programming** +49 8669 31-3102  
E-mail: [service.plc@heidenhain.de](mailto:service.plc@heidenhain.de)
- NC programming** +49 8669 31-3103  
E-mail: [service.nc-pgm@heidenhain.de](mailto:service.nc-pgm@heidenhain.de)
- Encoders / machine calibration** +49 8669 31-3104  
E-mail: [service.ms-support@heidenhain.de](mailto:service.ms-support@heidenhain.de)
- APP programming** +49 8669 31-3106  
E-mail: [service.app@heidenhain.de](mailto:service.app@heidenhain.de)

If you have questions about repairs, spare parts, or exchange units, please contact our Service department:

- Customer service, Germany** +49 8669 31-3121  
E-mail: [service.order@heidenhain.de](mailto:service.order@heidenhain.de)
- Customer service, international** +49 8669 31-3123  
E-mail: [service.order@heidenhain.de](mailto:service.order@heidenhain.de)

**Machine calibration** On request, HEIDENHAIN engineers will calibrate your machine's geometry (e.g., with a KGM grid encoder).

**Technical courses** HEIDENHAIN provides technical customer training in the following subjects:

- NC programming
- PLC programming
- TNC optimization
- TNC servicing
- Encoder servicing
- Special training for specific customers

**For more information on dates or registration:**

Technical training courses in Germany	+49 8669 31-3049
	E-Mail: <a href="mailto:mtt@heidenhain.de">mtt@heidenhain.de</a>
Technical training courses outside of Germany	<a href="http://www.heidenhain.de">www.heidenhain.de</a> EN ► Company ► Contact ► HEIDENHAIN worldwide

# Subject index

## A

Absolute encoders.....	29
Accessories.....	5
Analog nominal speed value.....	28
Analog speed command interface.....	30
API DATA.....	34
Axes.....	27
Axis clamping.....	30
Axis feedback control.....	30

## B

Backlash.....	32
Basic modules.....	15

## C

Cable overview.....	24
Commissioning and diagnostic aids.....	33
Commissioning wizard.....	33
ConfigDesign.....	33
Connecting cables.....	18
Context-sensitive help.....	31
Control components.....	12

## D

Data interfaces.....	41
Degrees of protection.....	44
DNC applications.....	43

## E

Electromagnetic compatibility.....	44
Electronic handwheels.....	17
Empty housing.....	15
Encoder inputs.....	29
Error compensation.....	32
Ethernet.....	41

## F

Feedforward control.....	30
Following error.....	30

## G

Gear ranges.....	28
------------------	----

## H

HEROS 5.....	26
HR 130.....	19, 51
HR 150.....	19, 51
HR 510.....	17, 48
HR 510 FS.....	17
HR 520.....	17, 48
HR 520 FS.....	17
HR 550 FS.....	18, 49
HRA 110.....	19, 52
HRA 551 FS.....	18, 50

Hysteresis.....	32
-----------------	----

## I

I/O modules.....	15
Incremental encoders.....	29
Installation elevation.....	45
Integrated PLC.....	36
Interfacing to the machine.....	7

## K

KinematicsDesign.....	31
-----------------------	----

## L

Linear axes.....	27
Linear error.....	32
Log.....	34

## M

Master keyword.....	13
MC 128.....	12, 46
Memory medium.....	12
Monitoring functions.....	31
Mounting and electrical installation.....	44
Multiple main spindles.....	28

## N

Nonlinear error.....	32
----------------------	----

## O

Online Monitor.....	34
Operating system.....	26
Options.....	11
Oscilloscope.....	33

## P

PL 510.....	15
PLA 4-4.....	15
PLC axes.....	27, 37
PLC basic program.....	39
PLCdesign.....	37
PLC expansion.....	36

PLC positioning.....	37
PLC programming.....	36
PLC soft keys.....	36
PLC window.....	36
PLD 16-8.....	15
Position-controlled spindle.....	28
Proper minimum clearance.....	44
Python OEM Process.....	38

## R

Rated operating current.....	36
------------------------------	----

RemoTools SDK.....	43
Rotary axes.....	27
RS-232-C/V.24.....	41

## S

Servo control.....	30
SIK component.....	12
Sliding friction.....	32
Snap-on keys.....	20, 22
Software.....	5
Specifications.....	6
Spindle.....	28
Spindle orientation.....	28
Spindle override.....	28
Static friction.....	32

## T

Table function.....	34
Tapping.....	28
TeleService.....	34
Thermal expansion.....	32
TNCalyzer.....	35
TNCkeygen.....	13
TNCremo.....	42
TNCremoPlus.....	42
TNCscope.....	34
TNCtest.....	35
Tool measurement.....	16
Touch probes.....	16
Trace function.....	34

## U

USB.....	41
USB hub.....	42, 55
User administration.....	26

## W

Workpiece measurement.....	16
----------------------------	----

# HEIDENHAIN

## DR. JOHANNES HEIDENHAIN GmbH

Dr.-Johannes-Heidenhain-Straße 5

83301 Traunreut, Germany

☎ +49 8669 31-0

FAX +49 8669 32-5061

E-mail: info@heidenhain.de

www.heidenhain.de

Vollständige und weitere Adressen siehe [www.heidenhain.de](http://www.heidenhain.de)  
For complete and further addresses see [www.heidenhain.de](http://www.heidenhain.de)

<b>DE</b>	<b>HEIDENHAIN Vertrieb Deutschland</b> 83301 Traunreut, Deutschland ☎ 08669 31-3132 FAX 08669 32-3132 E-Mail: hd@heidenhain.de	<b>ES</b>	<b>FARRESA ELECTRONICA S.A.</b> 08028 Barcelona, Spain www.farresa.es	<b>PH</b>	<b>MACHINEBANKS' CORPORATION</b> Quezon City, Philippines 1113 E-mail: info@machinebanks.com
	<b>HEIDENHAIN Technisches Büro Nord</b> 12681 Berlin, Deutschland ☎ 030 54705-240	<b>FI</b>	<b>HEIDENHAIN Scandinavia AB</b> 01740 Vantaa, Finland www.heidenhain.fi	<b>PL</b>	<b>APS</b> 02-384 Warszawa, Poland www.heidenhain.pl
	<b>HEIDENHAIN Technisches Büro Mitte</b> 07751 Jena, Deutschland ☎ 03641 4728-250	<b>FR</b>	<b>HEIDENHAIN FRANCE sarl</b> 92310 Sèvres, France www.heidenhain.fr	<b>PT</b>	<b>FARRESA ELECTRÓNICA, LDA.</b> 4470 - 177 Maia, Portugal www.farresa.pt
	<b>HEIDENHAIN Technisches Büro West</b> 44379 Dortmund, Deutschland ☎ 0231 618083-0	<b>GB</b>	<b>HEIDENHAIN (G.B.) Limited</b> Burgess Hill RH15 9RD, United Kingdom www.heidenhain.co.uk	<b>RO</b>	<b>HEIDENHAIN Reprezentantă Romania</b> Braşov, 500407, Romania www.heidenhain.ro
	<b>HEIDENHAIN Technisches Büro Südwest</b> 70771 Leinfelden-Echterdingen, Deutschland ☎ 0711 993395-0	<b>GR</b>	<b>MB Milionis Vassilis</b> 17341 Athens, Greece www.heidenhain.gr	<b>RS</b>	Serbia → <b>BG</b>
	<b>HEIDENHAIN Technisches Büro Südost</b> 83301 Traunreut, Deutschland ☎ 08669 31-1337	<b>HK</b>	<b>HEIDENHAIN LTD</b> Kowloon, Hong Kong E-mail: sales@heidenhain.com.hk	<b>RU</b>	<b>OOO HEIDENHAIN</b> 115172 Moscow, Russia www.heidenhain.ru
		<b>HR</b>	Croatia → <b>SL</b>	<b>SE</b>	<b>HEIDENHAIN Scandinavia AB</b> 12739 Skärholmen, Sweden www.heidenhain.se
<b>AR</b>	<b>NAKASE SRL.</b> B1653AOX Villa Ballester, Argentina www.heidenhain.com.ar	<b>HU</b>	<b>HEIDENHAIN Kereskedelmi Képviselet</b> 1239 Budapest, Hungary www.heidenhain.hu	<b>SG</b>	<b>HEIDENHAIN PACIFIC PTE LTD</b> Singapore 408593 www.heidenhain.com.sg
<b>AT</b>	<b>HEIDENHAIN Techn. Büro Österreich</b> 83301 Traunreut, Germany www.heidenhain.de	<b>ID</b>	<b>PT Servitama Era Toolsindo</b> Jakarta 13930, Indonesia E-mail: ptset@group.gts.co.id	<b>SK</b>	<b>KOPRETINA TN s.r.o.</b> 91101 Trenčín, Slovakia www.kopretina.sk
<b>AU</b>	<b>FCR MOTION TECHNOLOGY PTY LTD</b> Laverton North Victoria 3026, Australia E-mail: sales@fcrmotion.com	<b>IL</b>	<b>NEUMO VARGUS MARKETING LTD.</b> Holon, 58859, Israel E-mail: neumo@neumo-vargus.co.il	<b>SL</b>	<b>NAVO d.o.o.</b> 2000 Maribor, Slovenia www.heidenhain.si
<b>BE</b>	<b>HEIDENHAIN N.V.</b> 1760 Roosdaal, Belgium www.heidenhain.be	<b>IN</b>	<b>HEIDENHAIN Optics &amp; Electronics India Private Limited</b> Chetpet, Chennai 600 031, India www.heidenhain.in	<b>TH</b>	<b>HEIDENHAIN (THAILAND) LTD</b> Bangkok 10250, Thailand www.heidenhain.co.th
<b>BG</b>	<b>ESD Bulgaria Ltd.</b> Sofia 1172, Bulgaria www.esd.bg	<b>IT</b>	<b>HEIDENHAIN ITALIANA S.r.l.</b> 20128 Milano, Italy www.heidenhain.it	<b>TR</b>	<b>T&amp;M Mühendislik San. ve Tic. LTD. ŞTİ.</b> 34775 Y. Dudullu – Ümraniye-Istanbul, Turkey www.heidenhain.com.tr
<b>BR</b>	<b>HEIDENHAIN Brasil Ltda.</b> 04763-070 – São Paulo – SP, Brazil www.heidenhain.com.br	<b>JP</b>	<b>HEIDENHAIN K.K.</b> Tokyo 102-0083, Japan www.heidenhain.co.jp	<b>TW</b>	<b>HEIDENHAIN Co., Ltd.</b> Taichung 40768, Taiwan R.O.C. www.heidenhain.com.tw
<b>BY</b>	<b>GERTNER Service GmbH</b> 220026 Minsk, Belarus www.heidenhain.by	<b>KR</b>	<b>HEIDENHAIN Korea LTD.</b> Gasam-Dong, Seoul, Korea 153-782 www.heidenhain.co.kr	<b>UA</b>	<b>Gertner Service GmbH Büro Kiev</b> 02094 Kiev, Ukraine www.heidenhain.ua
<b>CA</b>	<b>HEIDENHAIN CORPORATION</b> Mississauga, Ontario L5T2N2, Canada www.heidenhain.com	<b>MX</b>	<b>HEIDENHAIN CORPORATION MEXICO</b> 20290 Aguascalientes, AGS., Mexico E-mail: info@heidenhain.com	<b>US</b>	<b>HEIDENHAIN CORPORATION</b> Schaumburg, IL 60173-5337, USA www.heidenhain.com
<b>CH</b>	<b>HEIDENHAIN (SCHWEIZ) AG</b> 8603 Schwerzenbach, Switzerland www.heidenhain.ch	<b>MY</b>	<b>ISOSERVE SDN. BHD.</b> 43200 Balakong, Selangor E-mail: sales@isoserve.com.my	<b>VN</b>	<b>AMS Co. Ltd</b> HCM City, Vietnam E-mail: davidgoh@amsvn.com
<b>CN</b>	<b>DR. JOHANNES HEIDENHAIN (CHINA) Co., Ltd.</b> Beijing 101312, China www.heidenhain.com.cn	<b>NL</b>	<b>HEIDENHAIN NEDERLAND B.V.</b> 6716 BM Ede, Netherlands www.heidenhain.nl	<b>ZA</b>	<b>MAFEMA SALES SERVICES C.C.</b> Midrand 1685, South Africa www.heidenhain.co.za
<b>CZ</b>	<b>HEIDENHAIN s.r.o.</b> 102 00 Praha 10, Czech Republic www.heidenhain.cz	<b>NO</b>	<b>HEIDENHAIN Scandinavia AB</b> 7300 Orkanger, Norway www.heidenhain.no		
<b>DK</b>	<b>TPTEKNIK A/S</b> 2670 Greve, Denmark www.tp-gruppen.dk	<b>NZ</b>	<b>Llama ENGINEERING Ltd</b> 5012 Wellington, New Zealand E-mail: info@llamaengineering.co.nz		

