



HEIDENHAIN



CNC PILOT 640

The Contouring Control for
Lathes and Turning-Milling
Machines

For Gen 3 drives

**Information for the
Machine Tool Builder**

Contouring control with drive system from HEIDENHAIN

General information

- CNC PILOT 640**
- Contouring control for **lathes and turning-milling machines**
 - Suitable for horizontal and vertical lathes as well as vertical boring and turning mills
 - Axes: max. 24 control loops (22 control loops with functional safety (FS)), max. 8 NC axes per channel, max. 6 spindles in the overall system
 - Up to three channels for asynchronous multi-slide machining
 - Up to 3 principal axes (X, Z, and Y), B axis, closed-loop spindle and counter spindle, C1/C2 axis, and driven tools
 - 5-axis simultaneous machining (X, Z, Y, B, and C axes)
 - Up to 3 programmable auxiliary axes (U, V, W) for control of steady rest, tailstock, and counter spindle
 - The position of a parallel secondary axis can be shown combined with its principal axis
 - For operation with HEIDENHAIN inverter systems and ideally with HEIDENHAIN motors
 - Fully digital with HSCI interface and EnDat interface
 - 24-inch, 19-inch, or 15.6-inch multi-touch display
 - CFR CompactFlash memory card (CFast)
 - Programming of turning, drilling, and milling operations with smart.Turn, according to DIN, or via cycles
 - TURN PLUS: automated smart.Turn program generation
 - ICP free contour programming for turning and milling contours
 - For simple tool holders (multifix), turrets, or magazines

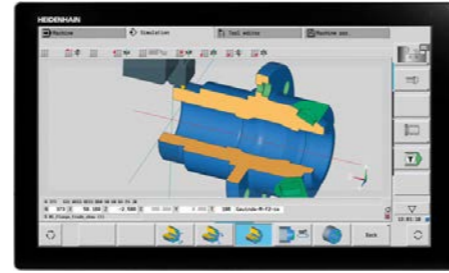

CNC PILOT 640 with 24-inch multi-touch display



CNC PILOT 640 with 15.6-inch multi-touch display

System test Controls, power modules, motors, and encoders from HEIDENHAIN are usually integrated as components into complete systems. In such cases, comprehensive testing of the complete system is required, irrespective of the specifications of the individual devices.

Parts subject to wear Controls from HEIDENHAIN contain parts subject to wear, such as a backup battery and fan.

Standards Standards (ISO, EN, etc.) apply only where explicitly stated in the brochure.

Note Intel, Intel Xeon, Core, and Celeron are registered trademarks of Intel Corporation.

Validity The features and specifications described here apply to the following control and NC software versions:

CNC PILOT 640 with NC software versions

- 688946-08 (export license required)
- 688947-08 (no export license required)

This brochure supersedes all previous editions, which thereby become invalid. **Subject to change without notice.**

Requirements Some of these specifications require particular machine configurations. Please also note that, for some functions, a special PLC program must be created by the manufacturer.

Functional safety (FS) If standard components and FS components (FS = Functional Safety) are not explicitly differentiated, then the information for both versions apply (e.g. TE 725T, TE 725T FS).

Contents

Contouring control with drive system from HEIDENHAIN	2
Overview tables	4
HSCI control components	16
Accessories	26
Cable overview	39
Technical description	46
Data transfer and communication	71
Mounting information	74
Key dimensions	76
General information	96
Subject index	98

Please note the page references in the tables with the specifications.

Using this brochure

This brochure is purely a decision-making aid for selecting HEIDENHAIN components. Additional documentation is required for project development (see "Technical documentation", Page 96).

Overview tables

Components

Control systems		24-inch design	19-inch design	15.6-inch design	Page
Main computer	<i>For operating panel</i>	MC 366 (1920 x 1080 pixels)	MC 8532 (1280 x 1024 pixels)	MC 8420T (1366 x 768 pixels)	16
	<i>For electrical cabinet</i>	MC 306		-	
Multi-touch display		BF 360 (1920 x 1080 pixels)	BF 860 (1280 x 1024 pixels)		21
Keyboard unit		TE 725T TE 725T FS TE 745T	TE 745T	TE 725T TE 725T FS	22
Machine operating panel		Integrated			
		PLB 6001, PLB 600x FS (HSCI adapter for OEM machine operating panel)			26
Storage medium		CFR memory card			18
NC software license		On SIK component			18
PLC inputs/ outputs¹⁾	With HSCI interface	PL 6000 consisting of PLB 62xx basic module (system PL) or PLB 61xx (expansion PL) and I/O modules			24
		On UEC ²⁾ and UMC ³⁾			
Additional modules¹⁾		CMA-H for analog axes/spindles in the HSCI system			27
		Modules for fieldbus systems			
Inverter systems²⁾		Compact inverters and modular inverters			
Connecting cables		✓			39

¹⁾ May be necessary depending on the configuration

²⁾ For more information, refer to the *Inverter Systems for Gen 3 Drives* brochure

³⁾ For more information, refer to the *Inverter Systems UV 1xx, UVR 1xx, UM 1xx, UEC 1xx, UE 2xx, UR 2xx* brochure

Please note: The MC main computer does not have any PLC inputs/outputs. Therefore one PL 6000, one UEC, or one UMC is necessary for each control. They feature safety-relevant inputs/outputs as well as the connections for touch probes.

Accessories

Accessory	CNC PILOT 640	Page
Electronic handwheels	<ul style="list-style-type: none"> • HR 510, HR 510 FS portable handwheel, or • HR 520, HR 520 FS portable handwheel with display, or • HR 550 FS portable wireless handwheel with display, or • HR 130 panel-mounted handwheel 	28
Workpiece touch probes¹⁾	<ul style="list-style-type: none"> • TS 260 touch trigger probe with cable connection, or • TS 460 touch trigger probe with radio and infrared transmission, or • TS 750 touch trigger probe with cable connection • TS 150 touch trigger probe with cable connection • TS 740 touch trigger probe with infrared transmission 	
Tool touch probes¹⁾	With cuboid probe contact as accessory <ul style="list-style-type: none"> • TT 160 touch trigger probe, or • TT 460 touch trigger probe with radio or infrared transmission 	
Programming station²⁾	DataPilot CP 640 Control software for PCs for programming, archiving, and training <ul style="list-style-type: none"> • Full version with single user license or network license • Demo version (free of charge) 	
Auxiliary axis control	PNC 610	33
Industrial PC	ITC 860: additional operating station with touchscreen and integrated keyboard IPC 306/IPC 6641: industrial PC for Windows IPC 6490/IPC 8420: industrial PC for PNC 610	31
Snap-on keys	For controls and handwheels	35

¹⁾ For more information, refer to the *Touch Probes* brochure

²⁾ For more information, refer to the *Programming Station for Turning Controls* brochure

Software tools	CNC PILOT 640	Page
PLCdesign¹⁾	PLC development software	67
TNCremo²⁾, TNCremoPlus²⁾³⁾	Data transfer software (TNCremoPlus with "live" screen)	72
ConfigDesign¹⁾	Software for configuring the machine parameters	63
TNCkeygen¹⁾	Software for enabling SIK options for a limited time, and for single-day access to the OEM area	18
TNCscope¹⁾	Software for data recording	64
TNCopt¹⁾	Software for putting digital control loops into service	64
IOconfig¹⁾	Software for configuring PLC I/O and fieldbus components	25
TeleService¹⁾³⁾	Software for remote diagnostics, monitoring, and operation	64
RemoTools SDK¹⁾	Function library for developing customized applications for communication with HEIDENHAIN controls	73
TNCtest¹⁾	Software for creation and execution of acceptance tests	65
TNCalyzer¹⁾	Software for the analysis and evaluation of service files	65

¹⁾ Available to registered customers for download from the Internet

²⁾ Available to all customers (without registration) for download from the Internet

³⁾ Software release module required

Specifications

Specification	CNC PILOT 640	Page
Axes	Max. 24 control loops (22 control loops with functional safety (FS)), max. 8 NC axes per channel, max. 6 spindles in the overall system	52
Axes	Up to 6 closed-loop linear axes X, Z, U, V, W: Standard Y: Option	
B axis	Option	
C1/C2 axis	Option	
Synchronized axes	✓	
PLC axes	✓	
Spindles	Up to 6 controlled spindles: Main spindle Counter spindle Driven tool	54 55
Speed	Max. 60 000 rpm (with option 49 max. 120 000 rpm) for motors with one pole pair	54
Operating mode switchover	✓	54
Position-controlled spindle	✓	54
Oriented spindle stop	✓	54
Gear shifting	✓	54
NC program memory	7.7 GB	16
Input resolution and display step		52
Linear axes	X axis: 0.5 µm (diameter 1 µm) U, V, W, Y, Z axes: 1 µm	
Rotary axes	B, C1/C2 axis: 0.001°	
Functional safety (FS)	With FS components, SPLC, and SKERN	48
For applications with up to	<ul style="list-style-type: none"> SIL 2 according to EN 61 508 Category 3, PL d as per EN ISO 13 849-1:2008 	
Interpolation		
Straight line	In 2 axes (maximum: ±100 m); in 3 main axes with software option 70	
Circular	In 2 axes (max. radius: 999 m); additional linear interpolation of the third axis with software option 55 or 70	
C1/C2 axis	Interpolation of the linear axes X and Z with the C1/C2 axis (software option 55)	
B axis	5-axis interpolation between the X, Z, Y, B, and C axis (software option 54)	
Multichannel machining	Up to three channels for asynchronous multi-slide machining (software option 153)	53
Axis feedback control		57
With following error	✓	
With feedforward	✓	
With jerk limiting	✓	52
Maximum feed rate	$\frac{60000 \text{ rpm}}{\text{No. of motor pole pairs}} \cdot \text{Screw pitch [mm]}$ at $f_{\text{PWM}} = 5000 \text{ Hz}$	52
Constant surface speed	✓	

Specification	CNC PILOT 640	Page																		
Input	mm/min or mm/revolution																			
Cycle times of main computer	MC	57																		
Block processing	1.5 ms																			
Cycle times of controller unit	CC/UEC/UMC	57																		
Path interpolation	3 ms	57																		
Fine interpolation	<i>Single-speed:</i> 0.2 ms <i>Double-speed:</i> 0.1 ms (software option 49)																			
Position controller	<i>Single-speed:</i> 0.2 ms <i>Double-speed:</i> 0.1 ms (software option 49)																			
Speed controller	<i>Single-speed:</i> 0.2 ms <i>Double-speed:</i> 0.1 ms (software option 49)																			
Current controller	<table border="0"> <tr> <td>f_{PWM}</td> <td>T_{INT}</td> </tr> <tr> <td>3.333 kHz</td> <td>150 µs</td> </tr> <tr> <td>4 kHz</td> <td>125 µs</td> </tr> <tr> <td>5 kHz</td> <td>100 µs</td> </tr> <tr> <td>6.666 kHz (software option 49)</td> <td>75 µs (software option 49)</td> </tr> <tr> <td>8 kHz (software option 49)</td> <td>62.5 µs (software option 49)</td> </tr> <tr> <td>10 kHz (software option 49)</td> <td>50 µs (software option 49)</td> </tr> <tr> <td>13.333 kHz (software option 49)</td> <td>37.5 µs (software option 49)</td> </tr> <tr> <td>16 kHz (software option 49)</td> <td>31.25 µs (software option 49)</td> </tr> </table>	f_{PWM}	T_{INT}	3.333 kHz	150 µs	4 kHz	125 µs	5 kHz	100 µs	6.666 kHz (software option 49)	75 µs (software option 49)	8 kHz (software option 49)	62.5 µs (software option 49)	10 kHz (software option 49)	50 µs (software option 49)	13.333 kHz (software option 49)	37.5 µs (software option 49)	16 kHz (software option 49)	31.25 µs (software option 49)	
f_{PWM}	T_{INT}																			
3.333 kHz	150 µs																			
4 kHz	125 µs																			
5 kHz	100 µs																			
6.666 kHz (software option 49)	75 µs (software option 49)																			
8 kHz (software option 49)	62.5 µs (software option 49)																			
10 kHz (software option 49)	50 µs (software option 49)																			
13.333 kHz (software option 49)	37.5 µs (software option 49)																			
16 kHz (software option 49)	31.25 µs (software option 49)																			
Permissible temperature range	Operation: In electrical cabinet: 5 °C to 40 °C In operating panel: 0 °C to 50 °C Storage: -20 to 60 °C																			

Interfacing to the machine

Interfacing to the machine	CNC PILOT 640	Page
Error compensation	✓	62
Linear axis error	✓	62
Nonlinear axis error	✓	62
Backlash	✓	62
Reversal spikes during circular movement	✓	62
Hysteresis	✓	62
Thermal expansion	✓	62
Static friction	✓	62
Sliding friction	✓	62
Integrated PLC	✓	66
Program format	Statement list	66
Program input at the control	✓	66
Program input via PC	✓	66
Symbolic PLC-NC interface	✓	66
PLC memory	4 GB	66
PLC cycle time	9 ms to 30 ms (adjustable)	66
PLC inputs/outputs	For the maximum configuration of the PLC system, see Page 47	24
PLC inputs, DC 24 V	Via PL, UEC, UMC	24
PLC outputs, DC 24 V	Via PL, UEC, UMC	24
Analog inputs ±10 V	Via PL	24
Inputs for PT 100 thermistors	Via PL	24
Analog outputs ±10 V	Via PL	24
PLC functions	✓	66
PLC soft keys	✓	67
PLC positioning	✓	67
PLC basic program	✓	69
Integration of applications		68
High-level language programming	Use of the Python programming language in conjunction with the PLC (software option 46)	68
User interfaces can be custom-designed	Creation of individualized user interfaces by the machine manufacturer with the Python programming language. Programs up to a memory limit of 10 MB are enabled in standard mode. More can be enabled via software option 46.	68

Interfacing to the machine	CNC PILOT 640	Page
Commissioning and diagnostic aids		63
TNCdiag	Software for the analysis of status and diagnostic information of digital drive systems	63
TNCopt	Software for putting digital control loops into service	64
ConfigDesign	Software for creating the machine configuration	63
Integrated oscilloscope	✓	63
Trace function	✓	64
API DATA function	✓	64
Table function	✓	64
OLM (online monitor)	✓	64
Log	✓	64
TNCscope	✓	64
Bus diagnostics	✓	64
Data interfaces	✓	
Ethernet	2 x 1000BASE-T	71
USB	Rear: USB 3.0 Front: may vary based on the component description	71
Protocols		71
Standard data transmission	✓	71
Blockwise data transfer	✓	71
LSV2	✓	71

Function	Standard	Option	CNC PILOT 640
DIN PLUS programming	✓		Programming in DIN 66025 format
	✓		Expanded command format (IF ... THEN ... ELSE ...)
	✓		Simplified geometry programming (calculation of missing data)
	✓		Powerful fixed cycles for area clearance, recessing, recess turning, and thread machining
		55	Powerful fixed cycles for drilling and milling with the C axis
		70	Powerful fixed cycles for drilling and milling with the Y axis
	✓		Subprograms
	✓		Technology functions for full-surface machining:
	✓		– Moving to a fixed stop
	✓		– Parting control
		131/132	– Spindle synchronization
		132	– Converting and mirroring
	✓		– Mechatronic tailstock
	✓		Programming with variables
	8/9	Contour description with ICP	
✓		Program verification graphics for workpiece blank and finished part	
✓		Turret assignment and other setup information in the DIN PLUS program	
	9	Conversion of smart.Turn units into DIN PLUS command sequences	
✓		Parallel programming	
✓		Parallel simulation	
Simulation	✓		Graphical simulation of the cycle process, or of the cycle, smart.Turn, or DIN PLUS program
	✓		Depiction of the tool paths as pencil-trace or cutting-path graphics; special identification of the rapid traverse paths
	✓		Machining simulation (2D material-removal graphics)
		55	Side or face view, or 2D view of cylindrical surface for verification of C-axis machining
	✓		Display of programmed contours
		54	View of the tilted plane (B-axis machining)
	✓		View of front face and YZ plane for verification of Y-axis machining
	✓		Three-dimensional rendering of the workpiece blank and finished part
	132	Simulation of mirrored contours for rear-face machining	
✓		Shifting and magnifying functions	
✓		Block scan in the simulation	
✓		Including for complex multi-channel machining operations	
Program-run graphics	✓		Graphical depiction of the current machining operation
B-axis machining		54	Machining with the B axis
	✓		Tilting the working plane
		54	Rotating the machining position of the tool
	9+54	Simultaneous turning	
Eccentric machining		135	Cycles for eccentric turning and for the manufacture of oval and polygonal contours
		135	Superimpositioning of traversing movements of the X and Y axes synchronously to the rotational motion of the spindle
Machining time analysis	✓		Calculation of machining times and idle times
	✓		Consideration of the switching commands triggered by the CNC
	✓		Representation of time per individual cycle or per tool change
Monitoring functions		151	Load Monitoring: detect tool wear and tool breakage during machining
		155	Component Monitoring: monitor for the overloading and wear of machine components

Function	Standard	Option	CNC PILOT 640
Tool database	✓		For 250 tools
		10	For 999 tools
	✓		Tool description can be entered for every tool
	✓		Automatic inspection of the tool-tip position relative to the machining contour
	✓		Compensation of the tool-tip position in the X/Y/Z plane
	✓		Fine compensation of tool via handwheel with application of compensation values in the tool table
	✓		Automatic tool-tip and cutter radius compensation
	✓		Tool monitoring for lifetime of the insert (tool tip) or the number of workpieces produced
		10	Tool monitoring with automatic tool change after end of tool life
	✓		Management of multipoint tools (multiple inserts or multiple reference points)
✓		Support of quick-change tool systems	
Technology database		8/9	Access to cutting data upon definition of workpiece material, cutting material, and the machining mode. The CNC PILOT 640 distinguishes between 16 machining modes. Each combination of workpiece material and tool material includes the cutting speed, the main feed rate, the secondary feed rate, and the infeed for the 16 machining modes.
		8/9	Automatic determination of the machining modes based on the cycle or the machining unit
		8/9	The cutting data are entered in the cycle or in the unit as suggested values
		8/9	9 combinations of workpiece material and tool material (144 entries)
		10	62 combinations of workpiece material and tool material (992 entries)
User management	✓		Configurable tying of permissions to user roles – Login at the control with a user account – User-specific HOME folder for simplified data management – Role-based access to the control and the network data
Conversational languages	✓		English, German, Czech, French, Italian, Spanish, Portuguese, Dutch, Swedish, Danish, Finnish, Norwegian, Slovenian, Slovak, Polish, Hungarian, Russian (Cyrillic), Romanian, Turkish, Chinese (traditional and simplified), Korean

Software options

Option number	Option	Starting with NC-Software 688946-688947-	ID	Comment	Page
0	Additional Axis 1	01	354540-01	Additional control loop 1	20
1	Additional Axis 2	01	353904-01	Additional control loop 2	20
2	Additional Axis 3	01	353905-01	Additional control loop 3	20
3	Additional Axis 4	01	367867-01	Additional control loop 4	20
4	Additional Axis 5	01	367868-01	Additional control loop 5	20
5	Additional Axis 6	01	370291-01	Additional control loop 6	20
6	Additional Axis 7	01	370292-01	Additional control loop 7	20
7	Additional Axis 8	03	370293-01	Additional control loop 8	20
8	Teach-in	01	632226-01	Cycle programming <ul style="list-style-type: none"> • Contour description with ICP • Cycle programming • Technology database with 9 combinations of workpiece materials and tool materials 	
9	smart.Turn	01	632227-01	smart.Turn <ul style="list-style-type: none"> • Contour description with ICP • Programming with smart.Turn • Technology database with 9 combinations of workpiece materials and tool materials 	
10	Tools and Technology	01	632228-01	Tools and technology <ul style="list-style-type: none"> • Tool database expanded to 999 entries • Technology database expanded to 62 combinations of workpiece materials and tool materials • Tool life monitoring with exchange tools 	
11	Thread Recutting	01	632229-01	Threads <ul style="list-style-type: none"> • Thread recutting • Handwheel superimposition during thread cutting 	
17	Touch Probe Functions	01	632230-01	Tool measurement and workpiece measurement <ul style="list-style-type: none"> • Determining tool-setting dimensions with a tool touch probe • Determining tool-setting dimensions with an optical gauge • Automatic workpiece measurement with a workpiece touch probe 	
18	HEIDENHAIN DNC	01	526451-01	Communication with external PC applications over COM component	73
24	Gantry Axes	01	634621-01	Gantry axes in master-slave torque control	53
42	DXF Import	01	632231-01	DXF import: Import of DXF contours	
46	Python OEM Process	01	579650-01	Python application on the control	68
49	Double-Speed Axes	01	632223-01	Short control-loop cycle times for direct drives	58
54	B-Axis Machining	01	825742-01	B axis: Tilting the working plane, rotating the machining position of the tool	53
55	C-Axis Machining	01	633944-01	C-axis machining	54
63	TURN PLUS	01	825743-01	TURN PLUS automatic generation of smart.Turn programs	

Option number	Option	Starting with NC-Software 688946-688947-	ID	Comment	Page
70	Y-Axis Machining	01	661881-01	Y-axis machining	
77	4 Additional Axes	03	634613-01	4 additional control loops	20
78	8 Additional Axes	03	634614-01	8 additional control loops	20
94	Parallel Axes	01	679676-01	Support of parallel axes (U, V, W) Combined display of principal axes and secondary axes	
101 - 130	OEM option	01	579651-01 to 579651-30	Options of the machine manufacturer	
131	Spindle Synchronism	01	806270-01	Synchronization (of two or more spindles)	55
132	Counter Spindle	01	806275-01	Counter spindle (spindle synchronism, rear-face machining)	54
133	Remote Desktop Manager	04	894423-01	Display and operation of external computer units (e.g., a Windows PC)	73
135	Synchronizing Functions	03	1085731-01	Expanded synchronization of axes and spindles	53
137	State Reporting	06	1232242-01	State Reporting Interface (SRI): Provision of operating conditions	64
143	Load Adapt. Control	01	800545-01	LAC: Load-dependent adaptation of control parameters	62
151	Load Monitoring	03	1111843-01	Monitoring of the tool load	61
153	Multichannel	05	1217032-01	Multi-channel capability: up to three channels for asynchronous multi-slide machining	53
155	Component Monitoring	07	1226833-01	Monitoring for component overloading and wear	61
160	Integrated FS: Basic	07	1249928-01	Enables functional safety and four safe control loops	48
161	Integrated FS: Full	07	1249929-01	Enables functional safety and maximum number of safe control loops	48
162	Add. FS Ctrl. Loop 1	07	1249930-01	Additional control loop 1	48
163	Add. FS Ctrl. Loop 2	07	1249931-01	Additional control loop 2	48
164	Add. FS Ctrl. Loop 3	07	1249932-01	Additional control loop 3	48
165	Add. FS Ctrl. Loop 4	07	1249933-01	Additional control loop 4	48
166	Add. FS Ctrl. Loop 5	07	1249934-01	Additional control loop 5	48
169	Add. FS Full	08	1319091-01	Enabling of all FS axis options or control loops. Options 160 and 162 to 166 must already be set.	48

HSCI control components

Main computer

- Main computer**
- The MC main computers feature the following:
- Processor
 - RAM
 - Gbit HSCI interface to the controller unit and to other control components
 - HDL2 interface to the BF monitor (with electrical cabinet versions)
 - 4 x USB 3.0 interface, e.g., to the TE 7x5T (FS) operating panel

To be ordered separately and installed in the main computer by the OEM:

- **CFR** memory card with the NC software
- The **System Identification Key (SIK)** component for the enabling of control loops and software options

The following HSCI components are required for operation of the CNC PILOT 640:

- MC main computer
- Controller unit
- **PLB 62xx** PLC I/O unit (system PL; integrated in UxC)
- TE 725T or TE 725T FS, or TE 745T keyboard unit with an integrated machine operating panel

Interfaces

For use by end users, the MC is equipped with the USB 3.0 and Ethernet interfaces. Connection to PROFIBUS DP or PROFINET IO is possible either via additional modules or by means of a combined PROFIBUS DP / PROFINET IO module.

Export version

Because the complete NC software is on the storage medium, no export version is required for the main computer itself. Only the easily replaceable storage medium and SIK component are available as export versions.

Gen 3 labels

The different Gen 3 labels identify how control components can be deployed.

Gen 3 ready

Gen 3 ready: These components can be used in systems with Gen 3 drives (UVR 3xx, UM 3xx, CC 3xx) and in systems with a 1xx inverter system (UVR 1xx, UE 2xx, UR 2xx, CC 61xx).

Gen 3 exclusive

Gen 3 exclusive: These components can be used only in systems with Gen 3 drives (UVR 3xx, UM 3xx, CC 3xx).

Versions

Various versions of the MC main computer are available:

- Installation into the **operating panel**:
The MC 8420T (15.6-inch), MC 8532 (19-inch), and MC 366 (24-inch), together with the BF monitor, make up a single unit and are installed directly into the operating panel. With the exception of the power supply line, only one HSCI connecting cable to the electrical cabinet is needed
- Installation in the **electrical cabinet**:
The MC 306 are installed in the electrical cabinet. The operating panel requires HSCI, USB, and HDL2 cables as control lines



MC 306

The MC 8420T and MC 8532 main computers are supported starting with NC software 68894x-05. The MC 306 and MC 366 main computers are supported starting with NC software 68894x-08. Earlier software versions do not run on these main computers.



MC 8420T with main computer installed on the back



MC 8532 with main computer installed on the back



MC 366 with main computer installed on the back



Gen 3 ready

	Installation type	Storage medium	Processor	RAM	Power consumption*)	Mass	ID
MC 8532	Operating panel	CFR	Intel Core i7-3, 1.7 GHz, dual-core	4 GB	≈ 75 W	≈ 7.5 kg	1189190-xx
MC 306	Electrical cabinet	CFR	Intel Xeon E3, 2.1 GHz, quad-core	8 GB	≈ 65 W	≈ 4.0 kg	1180045-xx
MC 8420T	Operating panel	CFR	Intel Celeron 1047 1.4 GHz, dual-core	4 GB	≈ 43 W	≈ 6.7 kg	1213689-xx
MC 366	Operating panel	CFR	Intel Core i7-3, 1.7 GHz, dual-core	8 GB	≈ 75 W	≈ 7.5 kg	1246689-xx

*) Test conditions: Windows 7 (64-bit) operating system, 100 % processor loading, no load on interfaces, no fieldbus module

Software options

Software options allow the performance of the CNC PILOT 640 to be adapted to one's actual needs at a later time. The software options are described on page 14. They are enabled by entering keywords based on the SIK number and are saved in the SIK component. Please provide the SIK number when ordering new options.

Storage medium

The storage medium is a CFR (CompactFlash Removable) compact flash memory card. It contains the NC software and is used to store NC and PLC programs. The storage medium is removable and must be ordered separately from the main computer.

This CFR uses the fast SATA protocol (CFast) for significantly shorter access times. This CFR is compatible with the MC units described in the **Main computers** section.

CFR CompactFlash, 30 GB	
Free PLC memory space	≈ 4 GB
Free NC memory space	≈ 7.7 GB
Export license required (NC-SW 688946-08)	ID 1075088-08
Export license not required (NC SW 688947-08)	ID 1075088-58



CFR CompactFlash

SIK component

The SIK component contains the **NC software license** for enabling control loops and software options. It gives the main computer an unambiguous ID code—the SIK number. The SIK component is ordered and shipped separately. It must be inserted into a slot provided for it in the MC main computer.

The SIK component with the NC software license exists in different versions based on the enabled control loops and software options. Additional control loops can be enabled later by entering a keyword. HEIDENHAIN provides the keyword, which is based on the SIK number.

When ordering, please provide the SIK number of your control. When the keywords are entered in the control, they are saved in the SIK component, thereby enabling and activating the software options. Should servicing become necessary, the SIK component must be inserted into the replacement control in order to enable all of the required software options.

Master keyword (general key)

For putting the CNC PILOT 640 into service, there is a master keyword that enables all software options once for 90 days. After this period, the software options can be activated only with the correct keywords. The general key is activated via a soft key.

TNCkeygen (accessory)

TNCkeygen is a collection of PC software tools for generating enabling keys for HEIDENHAIN controls for a limited period of time.

With the **OEM Key Generator**, you can generate enabling keys for software options by entering the SIK number, the software option to be enabled, the enabling period, and an OEM-specific password. This activation is limited to a period of 10 to 90 days. Each software option can be enabled only once; this is performed independently of the master keyword.

The **OEM daily key generator** generates an enabling key for the protected OEM area, thus granting the user access on the day it is generated.



SIK component

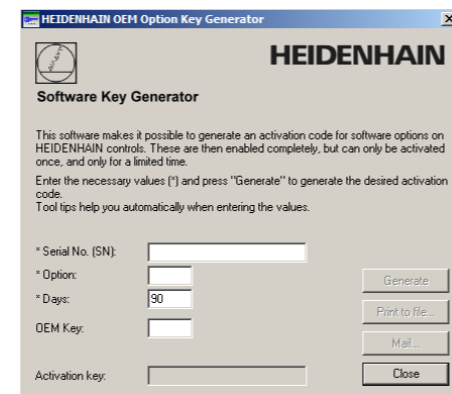

NC software license and enabling of control loops based on the CC

There are always three control loops enabled in the basic version. The controller unit must be designed for the corresponding number of activated control loops. Maximum numbers:

- UEC 3x4: 4 control loops
- UEC 3x4: 5 control loops
- CC 302: 2 control loops
- CC 308: 8 control loops
- CC 310: 10 control loops

You can find the usual SIK combinations in the following table. Other versions are available upon request.

Control loops	Included options	SIK
3	• smart.Turn (option 9)	ID 686002-01 ID 686002-51*)
	• Teach-in (option 8) • smart.Turn (option 9) • Thread Recutting (option 11) • C-Axis Machining (option 55)	ID 686002-10 ID 686002-60*)
4	• smart.Turn (option 9) • C-Axis Machining (option 55)	ID 686002-03 ID 686002-53*)
5	• smart.Turn (option 9) • C-Axis Machining (option 55)	ID 686002-04 ID 686002-54*)
5	• smart.Turn (option 9) • C-Axis Machining (option 55) • Y-Axis Machining (option 70)	ID 686002-62
6	• smart.Turn (option 9) • C-Axis Machining (option 55) • Y-Axis Machining (option 70)	ID 686002-05 ID 686002-55*)
6	• smart.Turn (option 9) • C-Axis Machining (option 55) • Counter Spindle (option 132)	ID 686002-63
7	• smart.Turn (option 9) • C-Axis Machining (option 55) • Y-Axis Machining (option 70) • Counter Spindle (option 132)	ID 686002-64

*) Export version

Enabling further control loops

Further control loops can be enabled either as groups or individually. The combination of control-loop groups and individual control loops makes it possible to enable any number of control loops. No more than 24 control loops (22 control loops with functional safety (FS)) are possible.

Control-loop groups	Software option	
4 additional control loops	77	ID 634613-01
8 additional control loops	78	ID 634614-01

Individual control loops	Software option	
1st additional control loop	0	ID 354540-01
2nd additional control loop	1	ID 353904-01
3rd additional control loop	2	ID 353905-01
4th additional control loop	3	ID 367867-01
5th additional control loop	4	ID 367868-01
6th additional control loop	5	ID 370291-01
7th additional control loop	6	ID 370292-01
8th additional control loop	7	ID 370293-01

19-inch display and keyboard

BF 860 monitor

Gen3 exclusive

- Supply voltage: DC 24 V/≈ 65 W
- **19-inch**; 1280 x 1024 pixels
- HDL2 interface to the MC in the electrical cabinet
- Integrated USB hub with 4 USB ports on the rear
- Display for multitouch operation

Via touchscreen operation

- Soft-key row switchover
- Screen layout
- Operating mode switchover

BF 860 ID 1244875-xx
Mass ≈ 7.5 kg



BF 860

TE 745T

Gen3 ready

- Suitable for MC 8532 or BF 860 (19-inch design)
- Numeric keypad
- ASCII keyboard
- Spindle-speed, feed-rate, and rapid-traverse override potentiometers
- Three holes for additional keys or keylock switches
- Touchpad and navigation keys
- Electronic handwheel
- USB interface to the MC main computer
- USB port with cover cap

Integrated machine operating panel with:

- Supply voltage: DC 24 V/≈ 4 W
- 36 exchangeable snap-on keys with LED status via PLC
- Operating elements: keys preassigned by the PLC basic program: Control voltage on¹⁾; NC start¹⁾; NC stop¹⁾; emergency stop; axis direction keys; rapid traverse key; spindle start; spindle stop; jog spindle; spindle change key; feed rate stop
- Connection for HR handwheel (due to the internal connector layout, no additional handwheels can be connected)
- HSCI interface
- 8 free PLC inputs and 8 free PLC outputs

¹⁾ Illuminated keys, addressable via PLC

TE 745T ID 801306-xx
Mass ≈ 4.5 kg



TE 745T

Keyboard suitable for 15.6-inch and 24-inch display

**TE 725T,
TE 725T FS**

Gen3 ready

- Suitable for MC 8420T
- Numeric keypad
- ASCII keyboard
- Spindle-speed and feed-rate override potentiometers
- Two holes for additional keys or keylock switches
- USB interface to the MC main computer
- USB port with cover cap

Integrated machine operating panel with:

- Supply voltage: DC 24 V / \approx 4 W
- 36 exchangeable snap-on keys with LED status via PLC
- Operating elements: keys preassigned by the PLC basic program: Control voltage on¹⁾; NC start¹⁾; NC stop¹⁾; emergency stop; axis direction keys; rapid traverse key; spindle start; spindle stop; jog spindle; spindle change key; feed rate stop
- Connection for HR handwheel
- HSCI interface
- TE 725T: 8 free PLC inputs and 8 free PLC outputs
- TE 725T FS: 4 free FS inputs and 8 free PLC outputs; additional dual-channel FS inputs for emergency stop and permissive buttons of the HR handwheel

¹⁾ Keys illuminated, addressable via PLC

**TE 725T
TE 725T FS**

Mass \approx 3.1 kg

ID 1264436-xx

ID 1211940-xx



TE 725T, TE 725T FS

24-inch display

BF 360 monitor

Gen3 exclusive

- Supply voltage: DC 24 V/ \approx 35 W
- **24-inch**; 1920 x 1024 pixels
- HDL2 interface to the MC in the electrical cabinet
- Integrated USB hub with 4 USB ports on the rear
- Display for multi-touch operation

Via touchscreen operation:

- Soft-key row switchover
- Screen layout
- Operating mode switchover

BF 360 ID 1275079-xx
Mass \approx 9.5 kg



BF 360

PL 6000 PLC input/output systems with HSCI

PL 6000

The PLC inputs and outputs are available via external modular PL 6000 PLC input/output systems. They consist of a basic module and one or more input/output modules. A total maximum of 1000 inputs/outputs is supported. The PL 6000 units are connected to the MC main computer via the HSCI interface. The PL 6000 units are configured with the IOconfig PC software.



PLB 62xx

Basic modules

Basic modules with an **HSCI interface** exist for 4, 6, 8, and 10 modules. Fastening is performed on standard NS 35 rails (DIN 46227 or EN 50022).

Supply voltage	DC 24 V
Power consumption ¹⁾	≈ 48 W at DC 24 V NC ≈ 21 W at DC 24 V PLC
Mass	≈ 0.36 kg (bare)

¹⁾ PLB 6xxx completely filled, incl. TS, TT

System PL with EnDat support

- Required once for each control system (except with UxC)
- Connections for TS and TT touch probes
- TS and TT touch probes with EnDat interface are supported
- *Without FS*: 12 free inputs, 7 free outputs
With FS: 6 free FS inputs, 2 free FS outputs
- Functional safety (FS) is enabled via SIK options 160 to 166
- Slots are equipped with cover strips

Gen3 ready

PLB 6204	For 4 I/O modules	ID 1129809-xx
PLB 6206	For 6 I/O modules	ID 1129812-xx
PLB 6208	For 8 I/O modules	ID 1129813-xx
PLB 6210	For 10 I/O modules	ID 1278136-xx

Gen3 exclusive

PLB 6204 FS	For 4 I/O modules	ID 1223032-xx
PLB 6206 FS	For 6 I/O modules	ID 1223033-xx
PLB 6208 FS	For 8 I/O modules	ID 1223034-xx
PLB 6210 FS	For 10 I/O modules	ID 1290089-xx

Expansion PL

Gen3 ready

For connection to the system PL to increase the number of PLC inputs/outputs

PLB 6104	For 4 I/O modules	ID 1129799-xx
PLB 6106	For 6 I/O modules	ID 1129803-xx
PLB 6108	For 8 I/O modules	ID 1129804-xx
PLB 6104 FS	For 4 I/O modules	ID 1129796-xx
PLB 6106 FS	For 6 I/O modules	ID 1129806-xx
PLB 6108 FS	For 8 I/O modules	ID 1129807-xx

Up to seven PLB 6xxx modules can be connected to the control.

I/O modules

Gen3 ready

There are I/O modules with digital and analog inputs and outputs.

PLD-H 16-08-00	I/O module with 16 digital inputs and 8 digital outputs	ID 594243-xx
PLD-H 08-16-00	I/O module with 8 digital inputs and 16 digital outputs	ID 650891-xx
PLD-H 08-04-00 FS	I/O module with 8 digital FS inputs and 4 digital FS outputs	ID 598905-xx
PLD-H 04-08-00 FS	I/O module with 4 digital FS inputs and 8 digital FS outputs	ID 727219-xx
PLD-H 04-04-00 HSLs FS	I/O module with 4 digital FS inputs and 4 high-side/low-side FS outputs	ID 746706-xx

Total current	Outputs 0 to 7: ≤ 2 A per output (≤ 8 A simultaneously)
Power output	Max. 200 W
Mass	≈ 0.2 kg

PLA-H 08-04-04	Analog module for PL 6xxx with <ul style="list-style-type: none"> • 8 analog inputs, ±10 V • 4 analog outputs, ±10 V • 4 analog inputs for PT 100 thermistors 	ID 675572-xx
Mass	≈ 0.2 kg	

I/O module for axis release

Gen3 exclusive

Axis-release module for external safety. In combination with the PLB 620x without FS

PAE-H 08-00-01	I/O module for enabling 8 axis groups	ID 1203881-xx
-----------------------	---------------------------------------	---------------

IOconfig (accessory)

PC software for configuring HSCI and PROFIBUS components

Accessories

HSCI adapter for OEM machine operating panel

PLB 600x

Gen3 ready

The PLB 600x HSCI adapter is required in order to connect an OEM-specific machine operating panel to the CNC PILOT 640.

- HSCI interface
- Connection for HR handwheel
- Inputs and outputs for keys and key illumination
 - PLB 6001:* Terminals for 72 PLC inputs / 40 PLC outputs
 - PLB 6001 FS:* Terminals for 36 FS inputs / 40 PLC outputs
 - PLB 6002 FS:* Terminals for 4 FS inputs, 64 PLC inputs, and 40 PLC outputs
- Screw fastening or top-hat-rail mounting
- Configuration of the PLC inputs/outputs with the IOconfig PC software

PLB 6001	ID 668792-xx
PLB 6001 FS	ID 722083-xx
PLB 6002 FS	ID 1137000-xx
Mass	≈ 1.2 kg

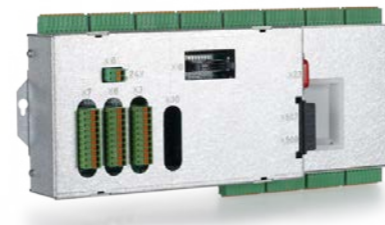

PLB 6001

Additional modules

Gen3 ready

Module for analog axes

Digital drive designs sometimes also require analog axes or spindles. The additional module CMA-H 04-04-00 (Controller Module Analog—HSCI) makes it possible to integrate analog drive systems in an HSCI system.

The CMA-H is integrated into the HSCI control system via a slot on the underside of the CC or UEC. Every controller unit has slots for two boards. The CMA-H does not increase the total number of available axes: every analog axis used reduces the number of available digital control loops by one. Analog control loops also need to be enabled on the SIK. The analog control-loop outputs can be accessed only via the NC, not via the PLC.

Additional module for analog axes/spindles:

- Expansion board for the CC or UEC controller units
- 4 analog outputs, ±10 V for axes/spindle
- Spring-type plug-in terminals

CMA-H 04-04-00 ID 688721-xx



CMA-H 04-04-00

Fieldbus systems

An expansion board can be used to provide the CNC PILOT 640 with a PROFIBUS or PROFINET interface at any time. The modules are integrated into the control system through a slot on the MC. This makes the connection to an appropriate fieldbus system as a master possible. As of version 3.0, the interface is configured with IOconfig.

PROFIBUS DP module

- Expansion board for the MC main computer
- Connection for 9-pin D-sub connector (female) to X121

MC 85x2, MC 366, MC 8420T ID 828539-xx
MC 306 ID 1279074-xx



PROFIBUS DP module

PROFINET IO module

- Expansion board for the MC main computer
- RJ45 connection at X621 and X622

MC 85x2, MC 366 and MC 8420T ID 828541-xx
MC 306 ID 1279077-xx



PROFINET IO module

Combined PROFIBUS DP/PROFINET IO module

- Expansion board for the MC main computer
- RJ45 connection at X621 (PROFINET IO) and M12 connector at X121 (PROFIBUS DP)
- Additionally connectable terminating resistor for PROFIBUS DP with front LED

MC 85x2, MC 366, and MC 8420T ID 1160940-xx
MC 306 ID 1233765-xx



Combined module

Electronic handwheels

Gen3 ready

Overview

Support for electronic handwheels is standard on the CNC PILOT 640:

- **HR 550 FS** wireless handwheel, or
- Portable handwheel **HR 510**, **HR 510 FS** or **HR 520**, **HR 520 FS** or
- **HR 130** panel-mounted handwheel

It is possible to operate more than one handwheel on a CNC PILOT 640:

- One handwheel on the handwheel input of the main computer (consider the interfaces of the given main computer)
- One handwheel each on HSCI machine operating panels or PLB 6001 or PLB 600x FS HSCI adapters (for the maximum number possible, see Page 47)

The mixed operation of handwheels with and without display is not possible. Handwheels with functional safety (FS) are short-circuit-proof due to special permissive-button logic.

HR 510

Portable electronic handwheel with:

- Keys for actual-position capture and the selection of five axes
- Keys for traverse direction and three preset feed rates
- Three keys for machine functions (see below)
- Emergency stop button and two permissive buttons (24 V)
- Magnetic holding pads

All keys are designed as snap-on keys and can be replaced with other symbols (see *Overview for the HR 510 in Snap-on keys for the HR*).

	Keys	Without detent	With detent
HR 510	NC start/stop, spindle start (for basic PLC program)	ID 1119971-xx	ID 1120313-xx
	FCT A, FCT B, FCT C	ID 1099897-xx	–
	Spindle right/left/stop	ID 1184691-xx	–
HR 510 FS	NC start/stop, spindle start (for basic PLC program)	ID 1120311-xx	ID 1161281-xx
	FCT A, FCT B, FCT C	–	ID 1120314-xx
	Spindle start, FCT B, NC start	–	ID 1119974-xx

Mass ≈ 0.6 kg



HR 510

HR 520

Portable electronic handwheel with:

- Display for operating mode, actual position value, programmed feed rate and spindle speed, error messages
- Override potentiometers for feed rate and spindle speed
- Selection of axes via keys or soft keys
- Actual position capture
- NC start/stop
- Spindle on/off
- Keys for continuous traverse of the axes
- Soft keys for machine functions of the machine manufacturer
- Emergency stop button

	Without detent	With detent
HR 520	ID 670302-xx	ID 670303-xx
HR 520 FS	ID 670304-xx	ID 670305-xx

Mass ≈ 1 kg

Holder for HR 520

For attaching to a machine

ID 591065-xx

HR 550 FS

Electronic handwheel with wireless transmission. Display, operating elements, and functions are like those of the HR 520

In addition:

- Functional safety (FS)
- Radio transmission range of up to 20 m (depending on environment)

HR 550 FS	Without detent	ID 1200495-xx
	With detent	ID 1183021-xx

Replacement battery	For HR 550 FS	ID 623166-xx
----------------------------	---------------	--------------

HRA 551 FS

Handwheel holder for HR 550 FS

- For docking the HR 550 FS onto the machine
- Integrated battery charger for HR 550 FS
- Connections to the control and the machine
- Integrated transceiver
- HR 550 FS magnetically held to front of HRA 551 FS

HRA 551 FS	ID 1119052-xx
Mass	≈ 1.0 kg

For more information, see the *HR 550 FS* Product Information document.



HR 520



HR 550 FS with HRA 551 FS

Connecting cables

	HR 510	HR 510 FS	HR 520	HR 520 FS	HR 550 FS with HRA 551 FS	
Connecting cable (spiral cable) to HR (3 m)	–	–	✓	✓	–	ID 312879-01
	✓	✓	–	–	–	ID1117852-03
Connecting cable with metal armor	–	–	✓	✓	–	ID 296687-xx
	✓	✓	–	–	–	ID 1117855-xx
Connecting cable without metal armor	–	–	✓	✓	✓ (max. 2 m)	ID 296467-xx
	✓	✓	–	–	–	ID 1117853-xx
HR adapter cable to MC, straight connector	✓	✓	✓	✓	✓ ¹⁾	ID 1161072-xx
HR adapter cable to MC, angled connector (1 m)	✓	✓	✓	✓	✓ ¹⁾	ID 1218563-01
Extension cable to adapter cable	✓	✓	✓	✓	✓ ¹⁾	ID 281429-xx
Adapter cable for HRA to MC	–	–	–	–	✓ ²⁾	ID 749368-xx
Extension cable to adapter cable	–	–	–	–	✓ ²⁾	ID 749369-xx
Adapter connector for handwheels without functional safety	✓	–	✓	–	–	ID 271958-03
Adapter connector for handwheels with functional safety	–	✓	–	✓	✓	ID 271958-05

¹⁾ For maximum cable lengths of 20 m between the MB and HRA 551 FS

²⁾ For maximum cable lengths of 50 m between the MB and HRA 551 FS

See also *Cable overview* on Page 45.

HR 130

Panel-mounted handwheel with ergonomic control knob.
It is attached to the TE 7x5T either directly or via an extension
cable.

HR 130	Without detent	ID 540940-03
	With detent	ID 540940-01
Mass	≈ 0.7 kg	



HR 130

Industrial PCs/ITC

Gen3 ready

Additional operating station with touchscreen

The additional ITC operating station (Industrial Thin Client) from HEIDENHAIN is a convenient solution for the additional, decentralized operation of the machine or of machine units such as tool changing stations. The remote operation strategy, which is tailored to the CNC PILOT 640, makes it very easy to connect the ITC over a standard Ethernet connection with a cable length of up to 100 m.

Connecting an ITC is very easy: as soon as the CNC PILOT 640 identifies an ITC, it provides it with a current operating system. After the ITC has been started, the complete content of the main screen is mirrored to the ITC's screen. As a result of this plug-and-play principle, no configuration by the machine manufacturer is necessary. With the standard configuration of the Ethernet interface at X116, the CNC PILOT 640 integrates the ITC into the system fully self-sufficiently.

The **ITC 860** and the separately orderable keyboard unit together form a complete, second operating station.

ITC 860	ID number	ID 1174935-xx
	Mass	≈ 8.2 kg
	Installation type	Operating panel
	Display	19-inch touchscreen (1280 x 1024 pixels)
	Processor	Intel Atom E3845 1.9 GHz
	RAM	2 GB
	Power consumption	≈ 50 W

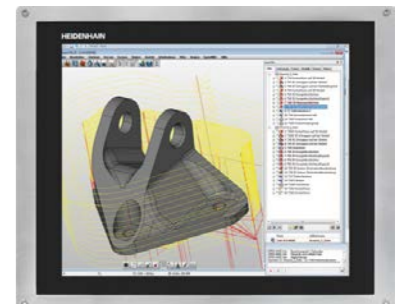

ITC 860

IPC 306 / IPC 6641 for Windows

With the help of the IPC 306 and IPC 6641 industrial PC, you can start and remotely operate Windows-based applications through the user interface of the CNC PILOT 640. The user interface is displayed on the control screen. Option 133 is required for this.

Since Windows runs on the industrial PC, it does not influence the NC machining process. The IPC is connected to the NC main computer via Ethernet. No second screen is necessary, since the Windows applications are displayed on the screen of the CNC PILOT 640 via remote accesses.

Along with the industrial PC, a separately orderable hard disk is required for operation. Windows 8 or 10 can be installed on the empty data carrier as the operating system.

IPC 306	ID number	ID 1179966-xx
	Installation type	Electrical cabinet
SSDR hard disk	Mass	≈ 5.0 kg
	RAM	8 GB RAM
	Processor	Intel Xeon, 2.1 GHz, quad-core
	Power consumption	65 W
	ID number	ID 1282884-51
	Storage capacity	≈ 240 GB

IPC 6641	With 8 GB of RAM	ID 1039543-01
	With 16 GB of RAM	ID 1039543-02
HDR hard disk	Mass	≈ 4.0 kg
	Installation type	Electrical cabinet
	Processor	Intel Core i7/3, 2.1 GHz, quad-core
	Power consumption	75 W
	ID number	ID 1074770-51
	Storage capacity	≈ 320 GB



IPC 306



IPC 6641

Control of auxiliary axes

Gen3 ready

PNC 610

The PNC 610 auxiliary axis control is designed for controlling PLC axes independently of the CNC PILOT 640. The PNC 610 does not have an NC channel and thus cannot perform interpolating NC movements. With the IPC auxiliary computer, SIK, and CFR storage medium, the PNC 610 is a separate HSCI system, which can be expanded with HEIDENHAIN inverters. The standard PNC 610 permits enabling of six PLC axes. Software option 46 (Python OEM Process) is enabled in the standard version. The PLC basic program contains a Python interface for pallet management that is adaptable by the machine manufacturer.

The system's design is identical to that of the CNC PILOT 640. All relevant HEIDENHAIN tools and a basic program can be used. The position information can be transmitted over PROFIBUS DP (optional), PROFINET IO (optional), or TCP/IP (integrated, system is not capable of real-time), regardless of the platform.

Auxiliary computer

The IPC auxiliary computer features the following:

- Processor
- RAM memory
- HSCI interface to the CC controller unit or to the UxC and to other control components
- USB 3.0 interface

The following components must be ordered separately by the OEM and installed in the auxiliary computer:

- CFR CompactFlash memory card with the NC software
- System Identification Key component (SIK) for enabling software options

The following HSCI components are required for operating the PNC 610:

- IPC auxiliary computer
- Controller unit
- PLB 62xx PLC I/O unit (system PL; integrated into UxC)

Interfaces

USB 3.0 and Ethernet are available to the user on the MC. The connection to PROFINET IO or PROFIBUS DP is possible via an additional module.

Design

IPC 6490	ID number	ID 1039541-xx
	Installation type	Electrical cabinet
	Mass	≈ 2.3 kg
	Power consumption	48 W
	RAM	2 GB
	Processor	Intel Celeron Dual Core, 1.4 GHz
IPC 8420	ID number	ID 1249510-xx
	Installation type	Operating panel
	Mass	≈ 6.7 kg
	Power consumption	48 W
	Display	15.6-inch touchscreen (1366 x 768 pixels)
	RAM	2 GB
	Processor	Intel Celeron Dual Core, 1.4 GHz

Export version

Because the complete NC software is saved on the CFR CompactFlash storage medium, no export version is required for the main computer itself. The NC software of the PNC 610 needs no export license.

Software options

The performance of the PNC 610 can also be adapted to the actual requirements at a later time through software options. Software options are enabled and saved in the SIK component through the entry of keywords based on the SIK number. Please provide the SIK number when ordering new options.

Option number	Option	ID	Remark	Page
18	HEIDENHAIN DNC	526451-01	Communication with external PC applications over COM component	
24	Gantry Axes	634621-01	Gantry axes in master-slave torque control	53
135	Synchronizing Functions	1085731-01	Expanded synchronization of axes and spindles	
143	Load Adapt. Control	800545-01	LAC: load-dependent adaptation of control parameters	62
160	Integrated FS: Basic	1249928-01	Enables functional safety and four safe control loops	48
161	Integrated FS: Full	1249929-01	Enables functional safety and maximum number of safe control loops (10)	48
162	Add. FS Ctrl. Loop 1	1249930-01	Additional control loop 1	48
163	Add. FS Ctrl. Loop 2	1249931-01	Additional control loop 2	48
164	Add. FS Ctrl. Loop 3	1249932-01	Additional control loop 3	48
165	Add. FS Ctrl. Loop 4	1249933-01	Additional control loop 4	48
166	Add. FS Ctrl. Loop 5	1249934-01	Additional control loop 5	48
169	Add. FS Full	1319091-01	Enabling of all FS axis options or remaining control loops Options 160 and 162 to 166 must already be set.	48

Storage medium

The storage medium is a CFR (CompactFlash Removable) compact flash memory card. This contains the NC software and must be ordered separately from the main computer. The NC software is based on the HEIDENHAIN HEROS 5 operating system.

CFR CompactFlash, 30 GB	ID 1102057-59
No export license required	
NC software	817591-09
Free PLC memory space	4 GB
Free NC memory space	7.7 GB

SIK component

The SIK component holds the NC software license for enabling software options. It gives the main computer an unambiguous ID code—the SIK number. The SIK component is ordered and shipped separately. It must be inserted into a special slot in the IPC auxiliary computer. The SIK component of the PNC can enable six axes. The enabling of up to the maximum number of ten axes must be performed via the UMC compact inverter.







































































































SIK component for PNC 610	ID 617763-53
----------------------------------	--------------

Snap-on keys for handwheels













































Snap-on keys

The snap-on keys make it easy to replace the key symbols, thus allowing the HR handwheel can be adapted to different requirements. The snap-on keys are available in packs of five keys.

Overview for HR 520, HR 520 FS, and HR 550 FS

Axis keys Orange	 A	ID 330816-42	 X	ID 330816-24	 U	ID 330816-43	 IV	ID 330816-37
	 B	ID 330816-26	 Y	ID 330816-36	 V	ID 330816-38		
	 C	ID 330816-23	 Z	ID 330816-25	 W	ID 330816-45		
Gray	 A-	ID 330816-95	 V+	ID 330816-69	 X-	ID 330816-0W	 Y+	ID 330816-0R
	 A+	ID 330816-96	 W-	ID 330816-0G	 X+	ID 330816-0V	 Y-	ID 330816-0D
	 B-	ID 330816-97	 W+	ID 330816-0H	 X-	ID 330816-0N	 Y+	ID 330816-0E
	 B+	ID 330816-98	 IV-	ID 330816-71	 X+	ID 330816-0M	 Z-	ID 330816-65
	 C-	ID 330816-99	 IV+	ID 330816-72	 Y-	ID 330816-67	 Z+	ID 330816-66
	 C+	ID 330816-0A	 X-	ID 330816-63	 Y+	ID 330816-68	 Z-↓	ID 330816-19
	 U-	ID 330816-0B	 X+	ID 330816-64	 Y-↖	ID 330816-21	 Z+↑	ID 330816-16
	 U+	ID 330816-0C	 X-↖	ID 330816-18	 Y+↖	ID 330816-20	 Z'↑	ID 330816-0L
	 V-	ID 330816-70	 X+↖	ID 330816-17	 Y-↖	ID 330816-0P	 Z'↓	ID 330816-0K
	 SPEC FCT	ID 330816-0X	 FN 3	ID 330816-75	 FN 3	ID 330816-0T	 FN 3	ID 330816-86
	 SPEC FCT	Black ID 330816-1Y	 FN 4	ID 330816-76	 FN 4	ID 330816-81	 FN 4	ID 330816-87
	 FCT A	Black ID 330816-30	 FN 5	ID 330816-77	 FN 5	ID 330816-82	 FN 5	ID 330816-88
 FCT B	Black ID 330816-31	 FN 5	ID 330816-78	 FN 5	ID 330816-83	 FN 5	ID 330816-94	
 FCT C	Black ID 330816-32	 FN 5	ID 330816-79	 FN 5	ID 330816-84	 FN 5	ID 330816-0U	
 FN 1	ID 330816-73	 FN 5	ID 330816-80	 FN 5	ID 330816-89	 FN 5	ID 330816-91	
 FN 2	ID 330816-74	 FN 5	ID 330816-0S	 FN 5	ID 330816-85	 FN 5	ID 330816-3L	
Spindle functions	 C0	Red ID 330816-08	 C0	ID 330816-40	 C0	Red ID 330816-47	 C0	ID 330816-48
	 C1	Green ID 330816-09	 C1	ID 330816-41	 C1	Green ID 330816-46	 C1	ID 385530-5X
Other keys	 Black	ID 330816-01	 Red	ID 330816-50	 ID 330816-90	 ID 330816-93		
	 Gray	ID 330816-61	 ID 330816-33	 ID 330816-27	 ID 330816-0Y			
	 NC 1	Green ID 330816-11	 ID 330816-34	 ID 330816-28	 Black ID 330816-4M			
	 NC 0	Red ID 330816-12	 ID 330816-13	 Black ID 330816-29	 ID 330816-3M			
	 Green	ID 330816-49	 Green ID 330816-22	 ID 330816-92	 ID 330816-3N			

Overview for HR 510 and HR 510 FS





















































































Axis keys Orange	 A	ID 1092562-02	 X	ID 1092562-05	 U	ID 1092562-36	 IV	ID 1092562-08
	 B	ID 1092562-03	 Y	ID 1092562-06	 V	ID 1092562-09		
	 C	ID 1092562-04	 Z	ID 1092562-07	 W	ID 1092562-37		
Gray	 X+	ID 1092562-28	 Y-	ID 1092562-31	 IV+	ID 1092562-24	 V-	ID 1092562-27
	 X-	ID 1092562-29	 Z+	ID 1092562-32	 IV-	ID 1092562-25		
	 Y+	ID 1092562-30	 Z-	ID 1092562-33	 V+	ID 1092562-26		
Machine functions	 FCT A	Black ID 1092562-14	 FCT B	Black ID 1092562-15	 FCT C	Black ID 1092562-16		ID 1092562-42
		ID 1092562-43		ID 1092562-44				
Spindle functions		ID 1092562-18		ID 1092562-19		Green ID 1092562-22		Red ID 1092562-17
		Red ID 1092562-38		ID 1092562-41				
Other keys		Black ID 1092562-01	 NC I	Green ID 1092562-23		ID 1092562-13		ID 1092562-35
		Green ID 1092562-20		ID 1092562-11		Black ID 1092562-10		Gray ID 1092562-39
		Red ID 1092562-21		ID 1092562-12		ID 1092562-34		Orange ID 1092562-40

Snap-on keys for the control

Snap-on keys

The snap-on keys make it easy to replace the key symbols, thus allowing the keyboard to be adapted to different requirements. The snap-on keys are available in packs of five keys.

Overview of control keys

Keys Orange	 V	ID 679843-31	 A	ID 679843-54	 X	ID 679843-C8	 U	ID 679843-D4	
	 IV	ID 679843-32	 W	ID 679843-55	 B	ID 679843-C9			
	 Z	ID 679843-53	 C	ID 679843-88	 Y	ID 679843-D3			
Gray	 X+	ID 679843-03	 VI+	ID 679843-13	 Y+	ID 679843-93	 Z+	ID 679843-B9	
	 X-	ID 679843-04	 VI-	ID 679843-14	 Y-	ID 679843-94	 Z-	ID 679843-C1	
	 Y+	ID 679843-05	 Y-↘	ID 679843-43	 B-	ID 679843-B1	 X-↘	ID 679843-C2	
	 Y-	ID 679843-06	 Y+↗	ID 679843-44	 B+	ID 679843-B2	 X+↗	ID 679843-C3	
	 Z+	ID 679843-07	 C+	ID 679843-67	 U-	ID 679843-B3	 X+	ID 679843-C4	
	 Z-	ID 679843-08	 C-	ID 679843-68	 U+	ID 679843-B4	 X-	ID 679843-C5	
	 IV+	ID 679843-09	 A+	ID 679843-69	 Y-↘	ID 679843-B5	 X-↘	ID 679843-D9	
	 IV-	ID 679843-10	 A-	ID 679843-70	 Y+↗	ID 679843-B6	 X+↗	ID 679843-E1	
	 V+	ID 679843-11	 Z+↑	ID 679843-91	 W-	ID 679843-B7			
	 V-	ID 679843-12	 Z-↓	ID 679843-92	 W+	ID 679843-B8			
	Machine functions	 ↗	ID 679843-01	 ↘	ID 679843-30		ID 679843-74		ID 679843-C6
		 ↘	ID 679843-02		ID 679843-40		ID 679843-76		Black ID 679843-C7
 ↗		ID 679843-16		Green ID 679843-56		Black ID 679843-95		ID 679843-D6	
 ↘		ID 679843-22		Red ID 679843-57		Black ID 679843-96		ID 679843-E3	
 ↗		ID 679843-23		+	ID 679843-59		Black ID 679843-A1		ID 679843-E4
 FN 1		ID 679843-24		-	ID 679843-60		ID 679843-A2		ID 679843-E6
 FN 2		ID 679843-25			ID 679843-61		ID 679843-A3		ID 679843-E7
 FN 3		ID 679843-26			ID 679843-62		ID 679843-A4		ID 679843-E8
 ↗		ID 679843-27		FCT	ID 679843-63		ID 679843-A5		
 ↘		ID 679843-28			ID 679843-64		ID 679843-A6		
 ↗		ID 679843-29			ID 679843-73		ID 679843-A9		

Control system with CC or UEC (MC in operating panel)

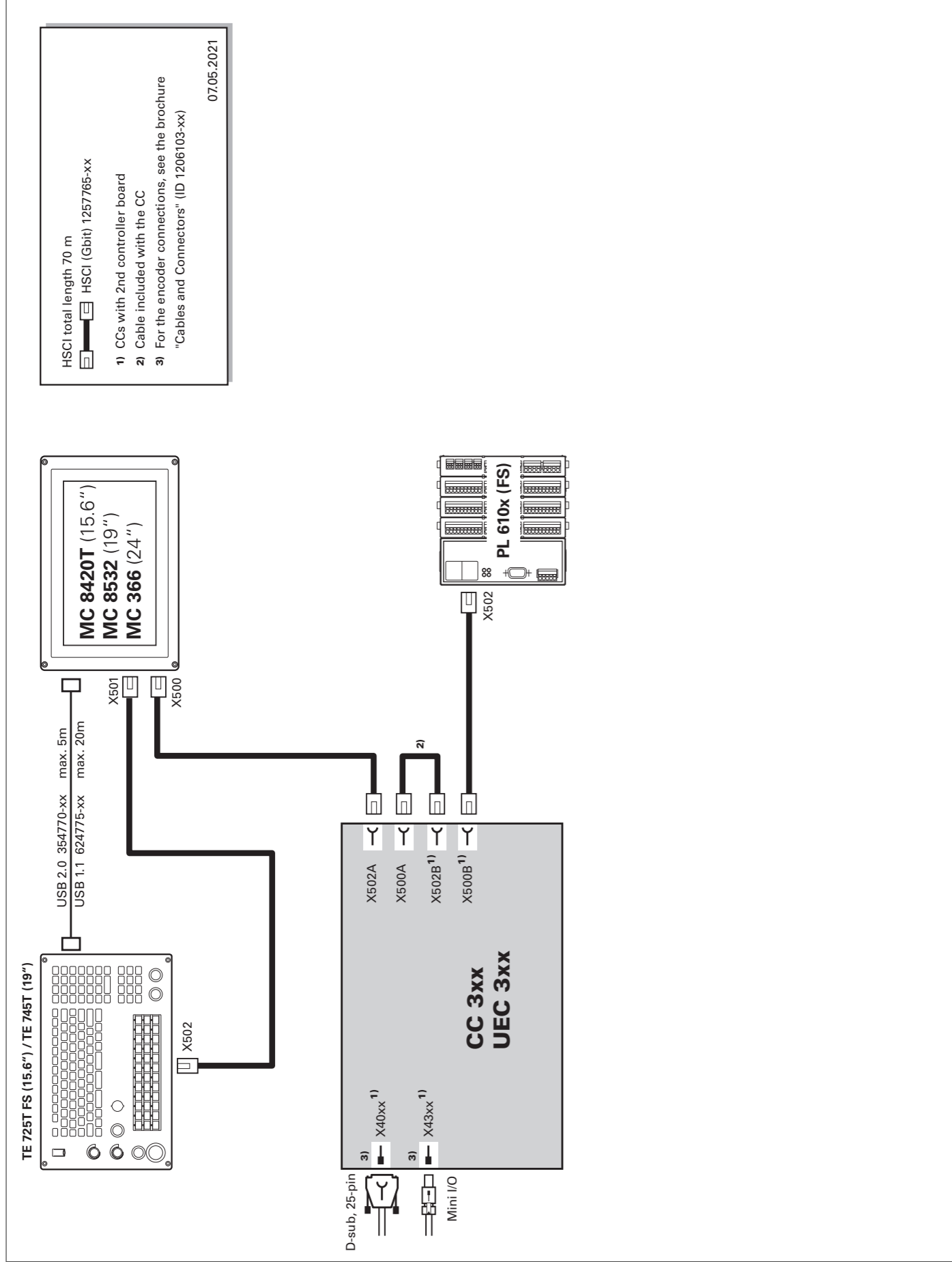

Encoders

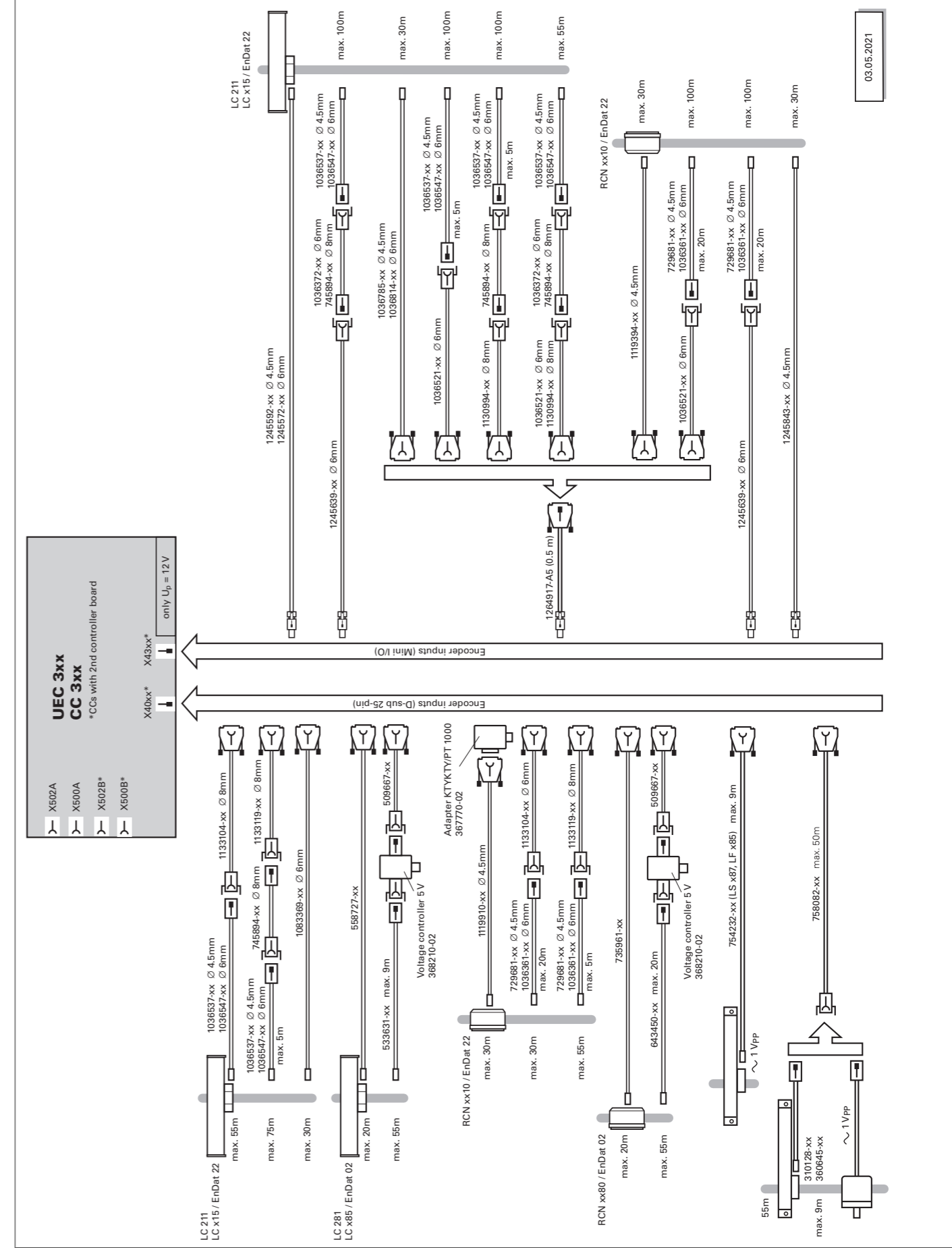

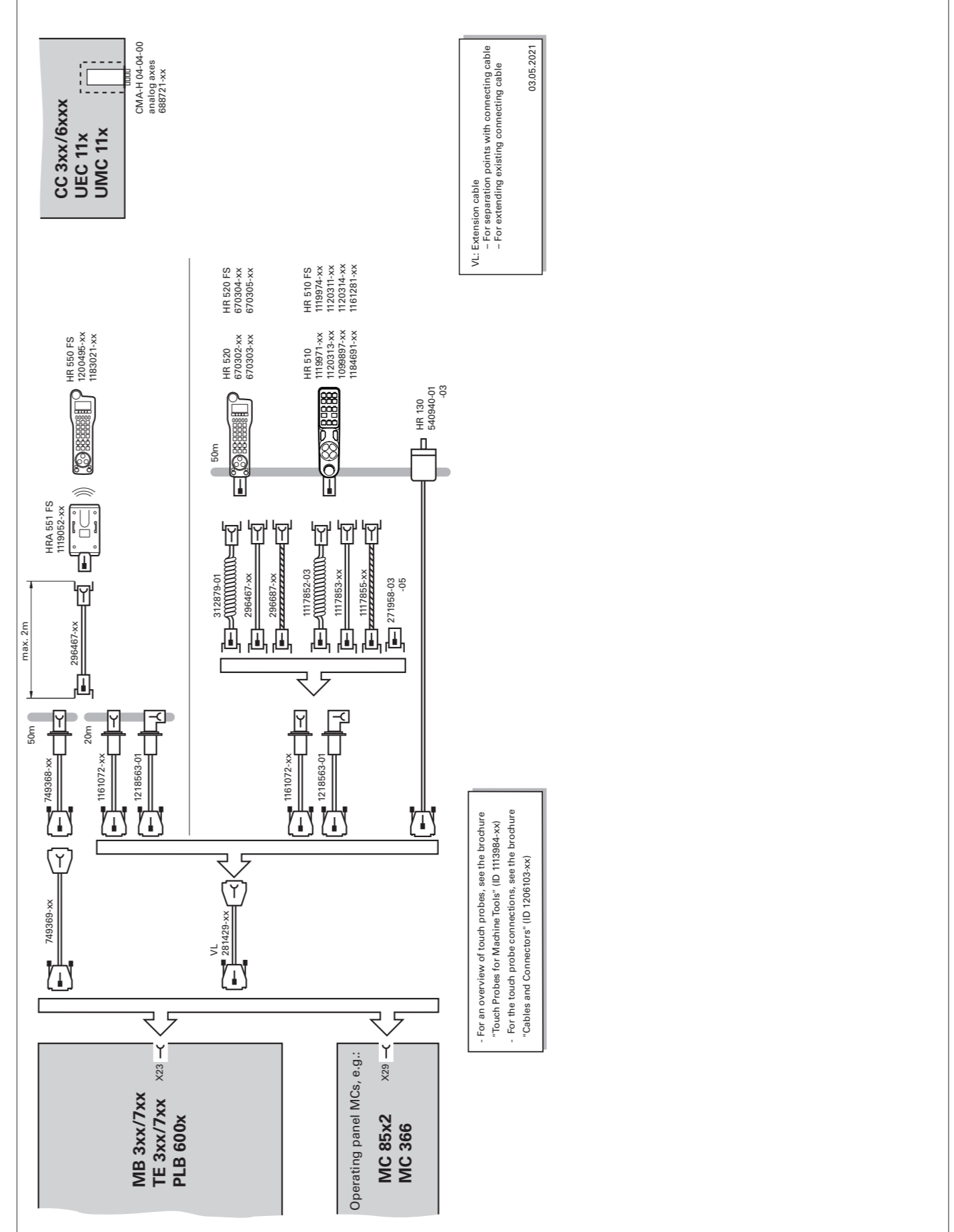
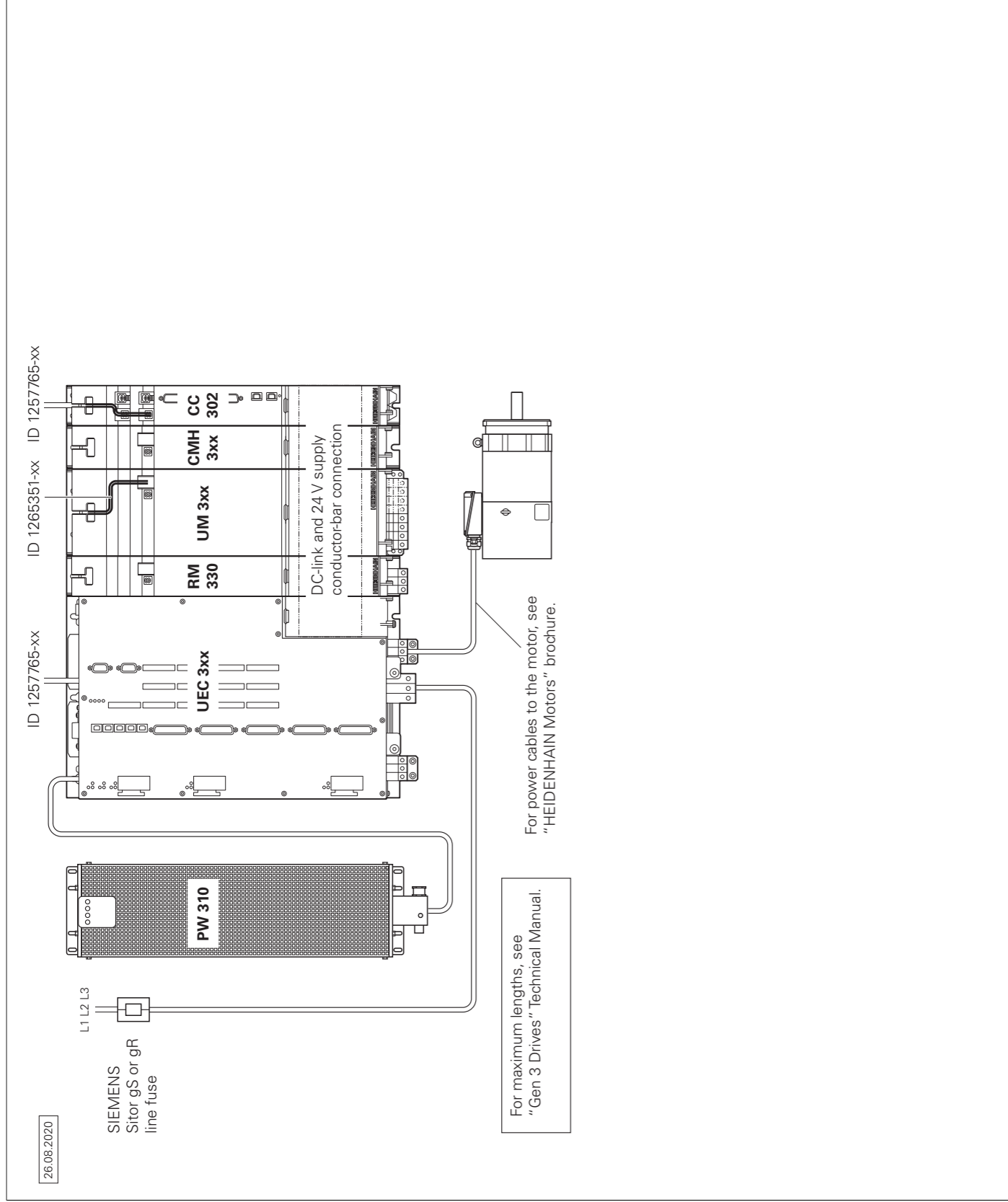

Technical description

Digital control design

Uniformly digital In the uniformly digital control design from HEIDENHAIN, all of the components are connected with each other via purely digital interfaces. A high degree of availability for the entire system, from the main computer to the encoder, is thereby achieved, with the system being diagnosable and immune to noise. The outstanding characteristics of the uniformly digital design from HEIDENHAIN guarantee very high accuracy and surface finish quality, combined with high traversing speeds.

Connection of the components:

- Control components via **HSCI** (HEIDENHAIN Serial Controller Interface), the HEIDENHAIN real-time protocol for Gigabit Ethernet
- Encoders via the **EnDat 2.2** bi-directional interface from HEIDENHAIN
- Power modules via digital optical fiber cables

HSCI HSCI, the HEIDENHAIN Serial Controller Interface, connects the main computer, controller(s), and other control components. The connection between two HSCI components is also referred to as an HSCI segment. HSCI communication in Gen 3 control systems is based on Gigabit Ethernet hardware. All HSCI components and HSCI cables must therefore be Gigabit-capable. A special interface component developed by HEIDENHAIN enables short cycle times for data transfer.

Main advantages of the control design with HSCI:

- Hardware platform for a flexible and scalable control system (e.g., decentralized axis systems)
- High noise immunity due to digital communication between components
- Hardware basis for implementing "functional safety"
- Simple wiring (commissioning, configuration)
- Inverter connection via digital optical fiber cables
- Long line lengths in the overall system
- High number of possible control loops
- High number of PLC inputs/outputs
- Decentralized arrangement of the controller units

CC or UEC controller units, up to nine PL 6000 PLC I/O modules, and machine operating panels (e.g., MB 72x from HEIDENHAIN) can be connected to the serial HSCI bus of the MC main computer. The HR handwheel is connected directly to the machine operating panel. The combination of monitor and main computer is especially advantageous if the computer is housed in the operating panel. Besides the power supply, all that is then required is an HSCI line to the controller unit in the electrical cabinet.

Maximum cable lengths for HSCI:

- For one HSCI segment: 70 m
- For up to 12 HSCI slaves: 290 m (total of HSCI segments)
- For up to 13 HSCI slaves (maximum configuration): 180 m (total of HSCI segments)

The maximum permissible number of individual HSCI participants is listed below:

Gbit HSCI component		Maximum number in the control system
MC, IPC	HSCI master	1
CC, UEC	HSCI slave	5 ¹⁾
UVR	HSCI slave	4
MB, PLB 600x	HSCI slave	2
PLB 6xxx (integrated in UEC 3xx (FS))	HSCI slave	7
PLB 6xxx FS (integrated in UEC 3xx FS)	HSCI slave	2
HR		5
PLD-H xx-xx-xx FS	In PLB 6xxx FS	10 ²⁾
PLD-H xx-xx-xx, PLA-H xx-xx-xx	In PLB 6xxx (FS)	25 ²⁾
PAE-H xx-xx-xx	In PLB 62xx	13 ³⁾
UEC 3xx for external safety	HSCI slave (PAE module integrated)	13 ³⁾

¹⁾ Controller motherboards distributed to CC or UEC as desired.

Increased to five units as of NCK software 597110-15 (for more information on the NCK software, see the *Technical Manual* of the respective control).

²⁾ Maximum total of 1000 inputs/outputs

³⁾ Only in systems without integrated functional safety (FS)

Control systems with integrated functional safety (FS)

Basic principle	With controls with integrated functional safety (FS) from HEIDENHAIN, Safety Integrity Level 2 (SIL 2) as per the standard EN 61508 and Performance Level "d" Category 3 as per EN ISO 13849-1 can be attained. In these standards, the assessment of safety-related systems is based on, among other things, the failure probabilities of integrated components and subsystems. This modular approach aids the manufacturers of safety-related machines in implementing their systems, since they can then build upon prequalified subsystems. This design is taken into account for the CNC PILOT 640 control, as well as for safety-related position encoders. Two redundant, mutually independent safety channels form the basis of the controls with functional safety (FS). All safety-relevant signals are captured, processed, and output via two channels. Errors are detected through a reciprocal data comparison of the two channels' states. Consequently, the occurrence of a single error in the control does not cause a loss in safety functionality.
Design	The safety-related controls from HEIDENHAIN have a dual-channel design with mutual monitoring. The SPLC (safety-related PLC program) and SKERN (safety kernel software) software processes are the basis of the two redundant systems. The two software processes run on the MC main computer (CPU) and CC controller unit components. The dual-channel configuration through MC and CC is continued in the I/O systems PLB 6xxx FS and TE 725T FS. This means that all safety-relevant signals (e.g., permissive buttons and keys, door contacts, emergency stop button) are captured via two channels, and are evaluated independently of each other by the MC and CC. The MC and CC use separate channels to also address the power modules, and to stop the motors in the event of an error.
Components	<p>In systems with functional safety, certain hardware components assume safety-relevant tasks. In systems with FS, only safety-relevant components are permitted to be used that, including their variant from HEIDENHAIN, are approved for this.</p> <p>Control components with functional safety FS can be recognized based on the addition of "FS" after the type designation, e.g., TE 725T FS.</p> <p>For a current list of the components approved for functional safety (FS), refer to <i>Functional safety (FS) supplement to the Technical Manual</i> (ID 1177599).</p>
MB and TE	An MB machine operating panel with functional safety (FS) is indispensable for systems with FS. Only on such a machine operating panel do all keys have a dual-channel design. Axes can be moved without additional permissive keys.
PLB	In systems with functional safety (FS), a combination of hardware (FS and standard) is possible, but a PLB 62xx FS is mandatory.
HR	In systems with functional safety (FS), FS handwheels are required because they are the only ones equipped with the required cross-circuit-proof permissive buttons.

Safety functions	Safety functions integrated into hardware and software: <ul style="list-style-type: none">• Safe stop reactions (SS0, SS1, and SS2)• Safe torque off (STO)• Safe operating stop (SOS)• Safely limited speed (SLS)• Safely limited position (SLP)• Safe brake control (SBC)• Safe operating modes<ul style="list-style-type: none">– Operating mode 1: Automated or production mode– Operating mode 2: Set-up mode– Operating mode 3: Manual intervention– Operating mode 4: Advanced manual intervention, process monitoring
-------------------------	---

Please note: Full functionality is not yet available for all machine types with functional safety (FS). Before planning a machine with functional safety (FS), please determine whether the current scope of features is sufficient for your machine design.

Activation of functional safety (FS)	The following requirements are absolutely necessary: <ul style="list-style-type: none">• At least one PLB 62xx FS must be present in the system• Safety-relevant control components in FS design (e.g., TE 725T FS, HR 550 FS)• Safety-related SPLC program• Configuration of safe machine parameters• Wiring of the machine for systems with functional safety (FS)
---	--

Functional safety (FS) can be scaled via the software options 160-166 and 169 (see Page 14). Only the number of safe drive systems actually needed must be enabled.

For every active drive that is assigned to a safe axis group, a safe control loop must be enabled. The control will otherwise display an error message.

For more information	For details, see the <i>Functional Safety FS</i> Technical Manual. Your contact person at HEIDENHAIN will be glad to answer any questions concerning controls with functional safety (FS).
-----------------------------	--

Control systems with external safety

Basic principle In control systems without integrated functional safety (FS), no integrated safety functions, such as safe operating modes, safe speed monitoring, or safe operating stop, are available. Such functions must be implemented entirely with the help of external safety components.

Control systems without integrated functional safety (FS) solely support the realization of the safety functions STO (safe torque off: dual-channel interruption of the motor power supply) and SBC (safe brake control: dual-channel triggering of the motor holding brakes). The dual-channel redundancy of the functions must be realized by the OEM through appropriate wiring.

Design In control systems with external safety, a special PL module for the dual-channel triggering of STO and SBC is absolutely necessary. This module is the PAE-H 08-00-01, with which up to eight axis groups can be individually controlled.

Operating system

HEROS 5 The CNC PILOT 640 and PNC 610 work with the real-time capable HEROS 5 operating system (HEIDENHAIN Realtime Operating System). This future-oriented operating system contains the following powerful functions as part of its standard repertoire:

Network

- Network: management of network settings
- Remote Desktop Manager: management of remote applications
- Printer: management of printers
- Shares: management of network shares
- VNC: virtual network computing server

Safety

- Portscan (OEM): port scanner
- Firewall: protection against undesired network access
- SELinux: protection against unauthorized changes to system files
- Sandbox: running applications in separated environments

System

- Backup/Restore: function for backing-up and restoring the software on the control
- HELogging: evaluation and creation of log files
- Perf2: system monitor
- User administration: define users with different roles and access permissions

Tools

- Web browser: Firefox®*)
- Document Viewer: display PDF, TXT, XLS, and JPEG files
- File Manager: file explorer for managing files and memory media
- Gnumeric: spreadsheet calculations
- Leafpad: text editor for creating notes
- Ristretto: display of image files
- Orage Calendar: simple calendar function
- Screenshot: creation of screendumps
- Totem: media player for playing audio and video files

User administration

The improper operation of a control often leads to unplanned machine downtime and costly scrap. The user administration feature can significantly improve process reliability through the systematic avoidance of improper operation. Through the configurable linkage of rights with user roles, access can be tailored to the activities of the respective user.

- Logging on to the control with a user account
- User-specific HOME folder for simplified data management
- Role-based access to the control and network data



*) Firefox is a registered trademark of the Mozilla Foundation

Axes

Overview

The CNC PILOT 640 is a contouring control for CNC lathes and is ideal both for horizontal and vertical lathes as well as vertical boring and turning mills. The CNC PILOT 640 supports lathes with main and counter spindle, C axis or positionable spindle, and driven tools, as well as machines with Y and B axes. In multi-channel machining, different machining steps can be carried out simultaneously using several slides.

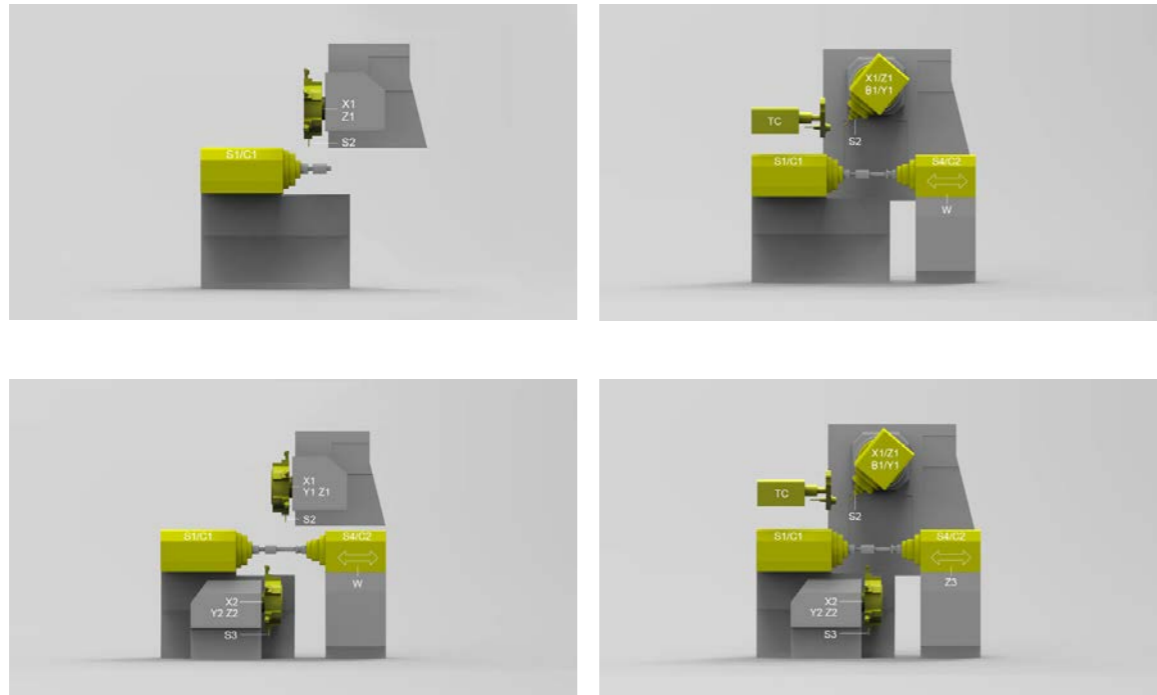

Display and programming

- Feed rate in
- mm/min
 - mm/revolution
 - Feed rate override: 0 % to 150 %
 - Maximum feed rate at $f_{PWM} = 5000$ Hz:

$$\frac{60000 \text{ rpm}}{\text{No. of motor pole pairs}} \cdot \text{Screw pitch [mm]}$$

Traverse range

-99999.9999 to +99999.9999 [mm]
The machine manufacturer defines the traverse range. The user can set additional limits to the traverse range if he wishes to reduce the working space (software limit switch). A protection zone for the spindle (Z-) can also be specified.

Tool carriers

The CNC PILOT 640 supports quick change tool posts (multifix), tool turrets, and tool magazines. The tool carriers can be located in front of or behind the workpiece.

Synchronized axes

Synchronized axes move in synchronism and are programmed with the same axis designation.

With HEIDENHAIN controls, parallel axis systems (gantry axes), such as on portal-type machines or tilting tables, can be moved synchronously to each other through high-accuracy and dynamic position control.

In the case of **gantry axes**, multiple gantry slave axes can be assigned to a single master axis. They may also be distributed to multiple controller units.

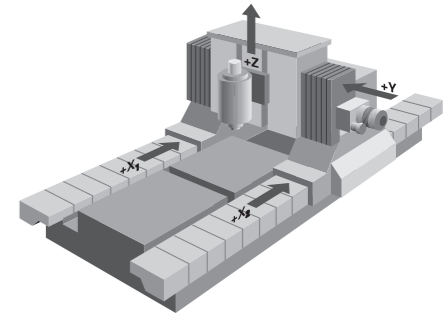

B Axis (software option 54)

With a B axis it is possible to drill, bore, and mill in oblique planes. Programming, as usual, can be done in the main plane.

Moreover, by tilting the B axis and rotating the tool you can bring it into positions that enable you, for example, to use a single tool to machine in the longitudinal and transverse directions on the main and counter spindles. The number of required tools and tool changes can thus be reduced.

Torque Control (software option 24)

Torque control is used on machines with mechanically coupled motors, for which

- a defined distribution of drive torque is desired, or
- parts of the controlled system show a backlash effect that can be eliminated by "tensioning" the motors (e.g. toothed racks).

For torque control, the master and slave must be on the same controller motherboard. Depending on the controller unit being used, up to five slave axes can thereby be configured for each master.

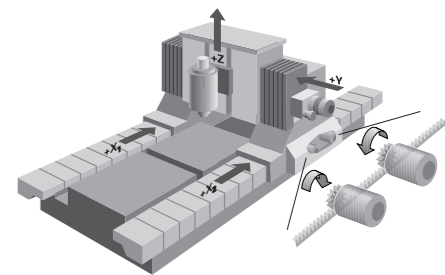

Real-time coupling function (software option 135)

The real-time coupling function (Synchronizing Functions) allows the cyclic calculation of a position offset for an axis from the actual and nominal values of any other axes in the system. This enables you to realize complex simultaneous movements of several NC or PLC axes. The mutual dependence of the axes is defined in mathematical formulas.

PLC axes

Axes can be defined as PLC axes. Programming is performed through M functions or OEM cycles. The PLC axes are positioned independently of the NC axes and are therefore designated as asynchronous axes.

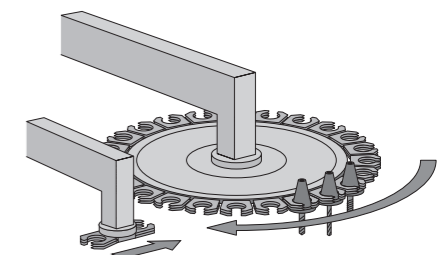

Multi-Channel Capability (software option 153)

Multi-channel machining provides up to three channels for asynchronous multi-slide machining. This is regardless of whether several slides simultaneously machine one workpiece or multiple workpieces in the workspace. Furthermore, with multi-channel machining the controlling of loading systems through a free machining channel is possible.

Spindle and counter spindle

Overview	<p>The CNC PILOT 640 contouring control operates in conjunction with the HEIDENHAIN inverter systems with field-oriented control. As an alternative, an analog nominal speed value can be output.</p> <p>For machines featuring a higher level of automation, you can position the spindle or counter spindle, or switch to C-axis operation.</p>
Controller unit	<p>With the CC controller units and the UEC/UMC inverters, a fundamental PWM frequency can be set for each output. In this case, every output can have its own fundamental PWM frequency (e.g., with the CC 306: X551 = 4 kHz, X552 = 5 kHz, etc.).</p> <p>Possible fundamental frequencies are 3.33 kHz, 4 kHz, or 5 kHz.</p> <p>With software option 49 (Double Speed Axes), this frequency can be increased to up to 16 kHz for fast-turning spindles (e.g., HF spindles).</p>
Display and programming	<p>Spindle speed:</p> <ul style="list-style-type: none">• Constant shaft speed: 1 to 99999 rpm• Constant surface speed: 1 to 9999 m/min
Spindle positioning	<p>Input resolution and display step: 0.001°</p>
Speed limiting	<ul style="list-style-type: none">• The CNC PILOT 640 monitors the actual speed.• Speed limiting can be adjusted via parameter and in the tool/spindle/feed-rate menu (TSF menu).
Spindle override	<p>50 % to 150 %</p>
Maximum spindle speed	<p>The maximum spindle speed is calculated as follows:</p> $n_{\max} = \frac{f_{\text{PWM}} \cdot 60000 \text{ rpm}}{\text{NPP} \cdot 5000 \text{ Hz}}$ <p>f_{PWM} = PWM frequency in Hz NPP = Number of pole pairs</p>
Gear ranges	<p>A specific parameter set can be defined for each gear range. The gears are switched via the PLC. Up to 10 gear ranges are supported.</p>
Operating mode switchover	<p>For controlling the spindle, different parameter sets can be saved for closed-loop control (e.g., for wye or delta connections). You can switch between the parameter sets in the PLC.</p>
Position-controlled spindle	<p>The position of the spindle is monitored by the control.</p>
Encoder	<p>HEIDENHAIN rotary encoder with sinusoidal voltage signals (1 V_{pp}) or EnDat interface.</p>
C-Axis Machining (software option 55)	<p>For milling, drilling, and boring cycles, either the spindle or counter spindle is switched to C-axis operation, or a separate C-axis drive is activated.</p> <p>Input resolution and display step: 0.001°</p>
Counter Spindle (software option 132)	<p>The Counter Spindle option is necessary in order to work with a counter spindle. The Spindle Synchronism option is included in the Counter Spindle option.</p>

Driven tools

Overview	<p>The driven tool is used for drilling and tapping holes as well as for milling in M19 or C-axis operation. Programs for the driven tool can be input in manual operation, via cycles with smart.Turn, or in the DIN editor.</p>
Display and programming	<p>Speed of the driven tool:</p> <ul style="list-style-type: none">• Constant shaft speed: 1 to 99999 rpm• Constant surface speed: 1 to 9999 m/min
Speed limiting	<ul style="list-style-type: none">• The CNC PILOT 640 monitors the actual speed.• Speed limiting can be adjusted via parameter and in the tool/spindle/feed-rate menu (TSF menu).
Spindle Synchronism (software option 131)	<p>The Spindle Synchronism option is necessary for special operations with a driven tool (e.g. polygonal turning.) This option is included in the Counter Spindle option.</p>

Encoders

Overview For speed and position control of the axes and spindle, HEIDENHAIN offers both incremental and absolute encoders.

Incremental encoders Incremental encoders have as their measuring standard a grating consisting of alternating lines and spaces. Relative movement between the scanning head and the scale causes the output of sinusoidal scanning signals. The measured value is calculated by counting the signals.

Reference mark After the machine has been switched on, the relationship between the measured value and the machine position must be established by traversing the reference marks. For encoders with distance-coded reference marks, the maximum travel until automatic reference mark storage for linear encoders is only 20 mm or 80 mm, depending on the model, or 10° or 20° for angle encoders.

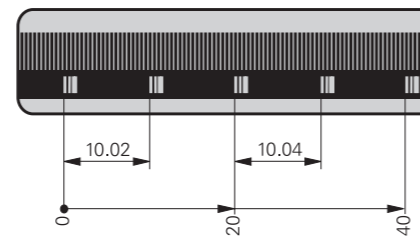

Evaluation of reference marks The routine for traversing the reference marks can also be started for specific axes via the PLC during operation (reactivation of parked axes).

Output signals Incremental encoders with sinusoidal output signals with ~ 1 V_{pp} levels are suitable for connection to HEIDENHAIN numerical controls.

Absolute encoders With absolute encoders, the position information is contained in several coded tracks. Thus, an absolute reference is available immediately after switch-on. A reference-mark traverse is not necessary. Additional incremental signals are output for highly dynamic control loops.

EnDat interface The CNC PILOT 640 features the serial EnDat 2.2 interface (includes EnDat 2.1) for the connection of absolute encoders.

Note: The EnDat interface on HEIDENHAIN encoders differs in its pin assignment from the interface on Siemens motors with integrated absolute ECN/EQN rotary encoders. Special adapter cables are available.

Encoder inputs Incremental and absolute linear, angle, or rotary encoders from HEIDENHAIN can be connected to all **position encoder** inputs of the controller unit.

Incremental and absolute rotary encoders from HEIDENHAIN can be connected to all **speed encoder** inputs of the controller unit.

Inputs	Signal level/ Interface ¹⁾	Input frequency ¹⁾	
		Position	Speed
Incremental signals	~1 V _{pp} EnDat 2.1	33 kHz/350 kHz	350 kHz
Absolute position values	EnDat 2.1 EnDat 2.2	–	–

¹⁾ Switchable

Digital servo control

Integrated inverter Position controllers, speed controllers, current controllers, and inverters are integrated into the CNC PILOT 640. HEIDENHAIN synchronous or asynchronous motors are connected to the CNC PILOT 640.

Axis feedback control The CNC PILOT 640 can control axes with servo lag or feedforward control. During roughing operations at high speeds, for example, you can switch to velocity semi-feedforward control via an OEM cycle in order to machine faster at reduced accuracy.

Operation with servo lag The term “servo lag” denotes the distance between the momentary nominal position and the actual position of the axis. The velocity is calculated as follows:

$$v = k_v \cdot s_a$$

v = Velocity
 k_v = Position loop gain
 s_a = Servo lag

Operation with feedforward control Feedforward means that a given velocity and acceleration are adapted to the machine. Together with the values calculated from the servo lag, this given velocity and acceleration becomes the nominal value. A much lower servo lag thereby manifests itself (in the range of only a few microns).

Compensation of torque ripples The torque of synchronous, torque, and linear motors is subject to periodic oscillations, one cause of which can be permanent magnets. The amplitude of this torque ripple depends on the motor design and, under certain circumstances, can have an effect on the workpiece surface. During initial configuration of the axes with TNCopt, this “torque ripple” can be compensated for by means of the Torque Ripple Compensation (TRC) function of the CC or UEC.

Control loop cycle times The cycle time for **path interpolation** is defined as the time interval during which interpolation points on the path are calculated. The cycle time for **fine interpolation** is defined as the time interval during which interpolation points are calculated that lie within the interpolation points calculated for path interpolation. The cycle time for the **position controller** is defined as the time interval during which the actual position value is compared to the calculated nominal position value. The cycle time for the **speed controller** is defined as the time interval in which the actual speed value is compared to the calculated nominal speed value. The cycle time for the **current controller** is defined as the time interval during which the actual value of the electrical current is compared to the calculated nominal value of the electrical current.

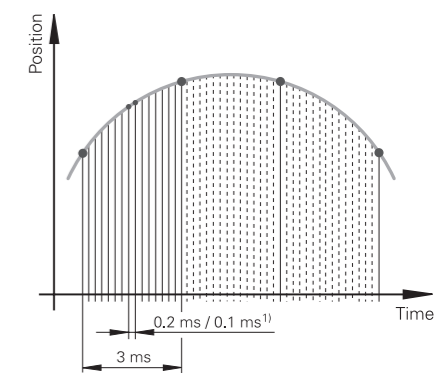

	CC/UEC/UMC
Path interpolation	3 ms
Fine interpolation	0.2 ms/0.1 ms ¹⁾ at f _{PWM} = 5000 Hz
Position controller	0.2 ms/0.1 ms ¹⁾ at f _{PWM} = 5000 Hz
Speed controller	0.2 ms/0.1 ms ¹⁾ at f _{PWM} = 5000 Hz
Current controller	0.1 ms at f _{PWM} = 5000 Hz

¹⁾ Double speed (with software option 49)

Axis clamping The control loop can be opened through the PLC in order to clamp specific axes.

Double speed control loops (software option 49)

Double-speed control loops permit higher PWM frequencies and shorter cycle times for the speed controller. This enables improved current control for spindles and higher controller performance for linear and torque motors.

Crossover Position Filter (CPF)

To increase the stability of the position control loop in systems with resonances, the position signal from the position encoder, which is filtered through a low-pass filter, is combined with the position signal from the motor speed encoder, which is filtered through a high-pass filter. This signal combination is made available to the position controller as the actual position value. The possible position controller gain (k_v factor) is increased significantly by this. The filter separation frequency is set specifically for each axis via machine parameters. The CPF can be used only in dual-encoder systems; i.e., on motors with a speed encoder and position encoder.

Fast machining

Look-ahead

The CNC PILOT 640 calculates the geometry ahead of time in order to adjust the feed rate. In this way, directional changes are detected in time to accelerate or decelerate the appropriate NC axes.

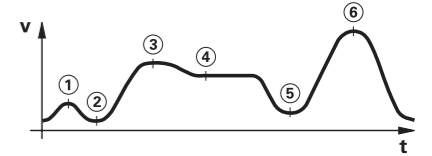
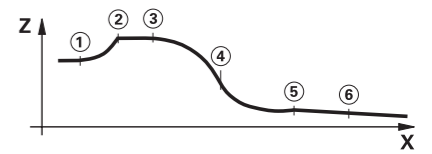

Jerk

The derivative of acceleration is referred to as jerk. A linear change in acceleration causes a jerk step. Such motion sequences may cause the machine to oscillate.

Jerk limiting

To prevent machine oscillations, the jerk is limited in order to attain optimum path control.

Smoothed jerk

The jerk is smoothed by nominal position value filters. The CNC PILOT 640 therefore mills smooth surfaces at the highest possible feed rate and yet keeps the contour accurate. The permitted tolerance is programmed by the user via a cycle. Special filters for HSC machining (HSC filters) can suppress machine-specific natural frequencies. The desired accuracy along with very high surface quality are attained.

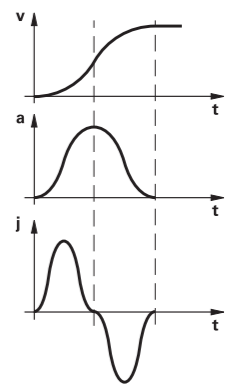

Advanced Dynamic Prediction (ADP)

The Advanced Dynamic Prediction (ADP) function enhances the conventional look-ahead of the permissible maximum feed rate profile, thereby enabling optimized motion control for clean surface finishes and perfect contours. The strengths of ADP are evident, for example, during bidirectional finish milling through symmetrical feed behavior on the forward and reverse paths, as well as through particularly smooth feed rate curves on parallel milling paths. NC programs that are generated on CAM systems have a negative effect on the machining process due to various factors such as short, step-like contours; coarse chord tolerances; and heavily rounded end-point coordinates. Through an improved response to such factors and the exact adherence to dynamic machine parameters, ADP not only improves the surface quality of the workpiece but also optimizes the machining time.

Monitoring functions

Description

During operation, the control monitors the following details*):

- Amplitude of the encoder signals
- Edge separation of the encoder signals
- Absolute position from encoders with distance-coded reference marks
- Current position (following error monitoring)
- Actual distance traversed (movement monitoring)
- Position deviation at standstill
- Nominal speed value
- Checksum of safety-related functions
- Supply voltage
- Voltage of the backup battery
- Operating temperature of the MC and CPU
- Run time of the PLC program
- Motor current / motor temperature
- Temperature of the power module
- DC-link voltage

With EnDat 2.2 encoders:

- The CRC checksum of the position value
- EnDat alarm Error1→ EnDat status alarm register (0xEE)
- EnDat alarm Error2
- Edge speed of 5 μs
- Transmission of the absolute position value on the time grid

In the event of hazardous errors, an emergency stop message is sent to the external electronics via the control-is-ready output, and the axes are brought to a stop. The correct connection of the CNC PILOT 640 in the machine's emergency stop loop is checked when the control system is switched on. In the event of an error, the control displays a message in plain language.

Context-sensitive help

A context-sensitive help function is available to the user via the Info key or the Info softkey or via the ERR key. In the event of an error message, the control displays the cause of the error and the possibilities for fixing it. The machine manufacturer can also implement this user support for PLC error messages.

Load Monitoring (software option 151)

This option monitors the load that occurs during machining processes in order to detect the wear or breakage of tools. By performing a reference operation for each machining step, the nominal load on the motors is determined. The actual motor load is then continuously compared to the nominal load. Up to four motors can be monitored per machining step. In the event of tool wear or breakage, two definable limit values trigger error reactions.

Tool wear

If the load and/or load integral exceed the limit values for tool wear, the CNC PILOT 640 designates the current tool as worn. With active tool life monitoring, the tool will automatically be replaced by a defined replacement tool the next time it is called.

Tool breakage

If the load exceeds the limit value for tool breakage, the CNC PILOT 640 immediately stops machining (cycle stop).

Meaningful error messages are issued if the limit values are exceeded. Furthermore, the CNC PILOT 640 can display the load values numerically and graphically in a separate window.

Component Monitoring (software option 155)

The overloading of machine components is often the cause of expensive machine damage and unplanned production downtime. Component monitoring keeps the user informed about the current load on the spindle bearings and reacts upon exceedance of the specified limit values (e.g., with an NC stop).

*1) No safety functions

Error compensation

Overview The CNC PILOT 640 automatically compensates for mechanical errors of the machine.

Linear error Linear error can be compensated over the entire travel range for each axis.

Nonlinear error The CNC PILOT 640 can compensate for ball-screw pitch errors and sag errors simultaneously. The compensation values are stored in a table. Nonlinear axis-error compensation also makes it possible to compensate for position-dependent backlash.

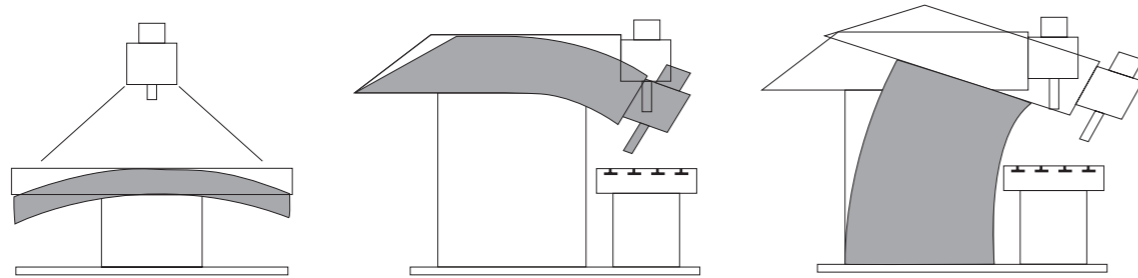

Backlash The play between table movement and rotary encoder movement during direction changes can be compensated for in length measurements by the spindle and rotary encoder. This backlash is outside the controlled system.

Hysteresis The hysteresis between the table movement and motor movement is also compensated for in direct length measurements. In this case, the hysteresis is within the controlled system.

Reversal spikes In circular movements, reversal spikes can occur at quadrant transitions due to mechanical influences. The CNC PILOT 640 can compensate for these reversal spikes.

Static friction At very low feed rates, high static friction can cause the slide to stop and start repeatedly for short periods. This is commonly known as stick-slip. The CNC PILOT 640 can compensate for this problematic behavior.

Sliding friction Sliding friction is compensated for by the speed controller of the CNC PILOT 640.

Thermal expansion To compensate for thermal expansion, the machine's expansion behavior must be known.

The temperature is measured via thermistors connected to the analog inputs of the CNC PILOT 640. The PLC evaluates the temperature information and passes a compensation value to the NC.

Load Adaptive Control (LAC, software option 143) With LAC (software option 143), you can dynamically adjust controller parameters based on the load or friction.

In order to optimize changed control behavior at differing loads, adaptive feedforward controls can exploit data on acceleration, holding torque, static friction, and friction.

Initial setup and diagnostic aids

Overview The CNC PILOT 640 provides comprehensive internal commissioning and diagnostic aids. It also includes highly effective PC software for diagnostics, optimization, and remote control.

ConfigDesign (accessory) PC software for configuring the machine parameters

- Stand-alone machine-parameter editor for the control; all supporting information, additional data, and input limits are shown for the parameters
- Configuration of machine parameters
- Comparison of parameters from different controls
- Importing of service files: easy testing of machine parameters in the field
- Rule-based creation and management of machine configurations for multiple controls (together with PLCdesign)

TNCdiag The HEIDENHAIN TNCdiag application evaluates the status and diagnostic information of HEIDENHAIN components (with an emphasis on the drive systems) and graphically images the data:

- Status and diagnostic information about the HEIDENHAIN components (drive electronics, encoders, input/output devices, etc.) connected to the control
- History of the recorded data
- Replaces DriveDiag for Gen 3 drives

TNCdiag comes in a PC version for the analysis of service files and in a control version for the display of live data.

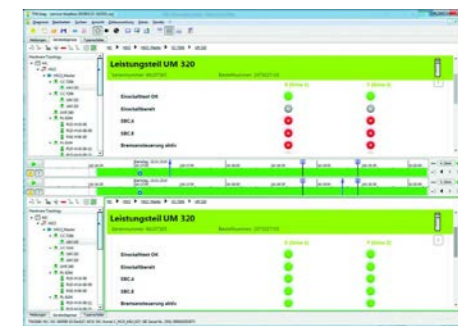

Oscilloscope The CNC PILOT 640 features an integrated oscilloscope. Both X/t and X/Y graphs are possible. The following characteristic curves can be recorded and stored in six channels:

- Actual value and nominal value of the axis feed rate
- Contouring feed rate
- Nominal and actual position
- Following error of the position controller
- Content of PLC operands
- Encoder signal (0°-A) and (90°-B)
- Difference between position and speed encoder
- Nominal velocity value
- Integral-action component of the nominal current value
- Torque-determining nominal current value

Logic signals Simultaneous graphical representation of the logic states of up to 16 operands (markers, words, inputs, outputs, counters, timers)

- Marker (M)
- Input (I)
- Output (O)
- Timer (T)
- Counter (C)
- IpoLogic (X)

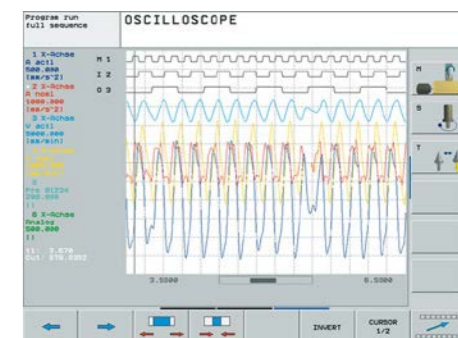

**TNCopt
(accessory)**

PC software for commissioning digital control loops.
Functions (among others):

- Initial setup of the current controller
- (Automatic) initial setup of the velocity controller
- (Automatic) optimization of sliding-friction compensation
- (Automatic) optimization of compensation for reversal spikes
- (Automatic) optimization of the k_v factor
- Circular interpolation test, contour test

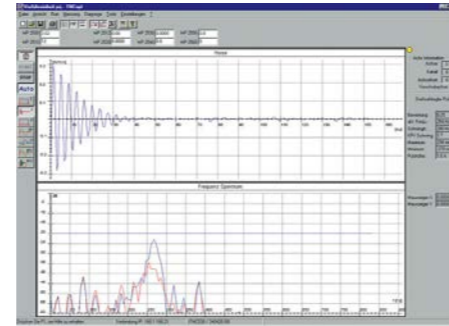
**Online Monitor
(OLM)**

The online monitor is a component of the CNC PILOT 640 and is called with a code number. It supports commissioning and diagnosis of control components through the following:

- Display of control-internal variables for axes and channels
- Display of controller-internal variables (if a CC is present)
- Display of hardware signal states
- Various trace functions
- Activation of spindle commands
- Enabling of control-internal debug outputs

**TNCscope
(accessory)**

PC software for transferring the oscilloscope files to a PC. With TNCscope you can record and save up to 16 channels simultaneously.

API DATA

With the API DATA function, the control displays the states or contents of the symbolic API markers and API double words.

Table function

The current conditions of the markers, words, inputs, outputs, counters, and timers are displayed in tables. The conditions can be changed through the keyboard.

Trace function

The current content of the operands and the accumulators is shown in the statement list in each line in hexadecimal or decimal code. The active lines of the statement list are marked.

Log

For the purpose of error diagnostics, all error messages and keystrokes are recorded in a log. The entries can be read using the **PLCdesign** or **TNCremo** software for PCs.

**TeleService
(accessory)**

PC software for remote diagnostics, remote monitoring, and remote operation of the control. For more information, please ask for the *Remote Diagnosis with TeleService* Technical Information sheet.

Single station license ID 340449-xx

Bus diagnosis

In Diagnosis mode, the structure of the connected bus systems as well as the details of the connected components can be shown in an intuitive manner.

**State Reporting
(software
option 137)**

With the State Reporting Interface (SRI) software option, HEIDENHAIN offers an interface for the simple provision of machine operating states for a higher-level machine data or production data acquisition system (MDA/PDA).

TNCtest

Acceptance tests on machine tools with external or integrated functional safety (FS) must be conducted reproducibly and verifiably.

The TNCtest and TestDesign program package can be used to plan and perform acceptance tests for machine tools with HEIDENHAIN controls. The acceptance tests are planned with TestDesign and run with TNCtest.

The TNCtest programs are designed to provide support during acceptance testing, provide required information, and perform automatic configurations, as well as record data and evaluate the data semiautomatically. A tester must evaluate manually whether a test case passed or failed.

TNCAnalyzer

The TNCAnalyzer application from HEIDENHAIN provides for simple and intuitive evaluation of service files and log files.

Function:

- Loading of service and log files
- Analysis of temporal sequences and static states
- Filters and search functions
- Data export (HELogger, CSV, and JSON formats)
- Definition of application-specific analysis profiles
- Preconfigured analysis profiles
- Graphical display of signals via TNCscope
- Interaction with other tools that are intended for the display of special sections of the service file

Integrated PLC

Overview The PLC program is created by the machine manufacturer either at the control or with the PLC development software **PLCdesign** (accessory). Machine-specific functions are activated and monitored via the PLC inputs/outputs. The number of PLC inputs/outputs required depends on the complexity of the machine.

PLC inputs/outputs PLC I/Os are available via the external PL 6000 or UxC 3xx. The PLC I/Os and the PROFINET IO or PROFIBUS DP-capable I/O system must be configured with the IOconfig PC software.

PLC programming	Format	Statement list
	Memory	4 GB
	Cycle time	9 ms to 30 ms (adjustable)
	Command set	<ul style="list-style-type: none"> • Bit, byte, and word commands • Logical operations • Arithmetic commands • Comparisons • Bracketed terms • Jump commands • Subprograms • Stack operations • Submit programs • Timers • Counters • Comments • PLC modules • Strings

Encryption of PLC data The encrypted PLC partition (PLCE:) provides the machine manufacturer with a tool for preventing third parties from viewing or changing files. The files on the PLCE partition can be read only by the control itself or by using the correct OEM keyword. This ensures that proprietary know-how and special customer-specific solutions cannot be copied or changed.

The machine manufacturer can also determine the size of the encrypted partition. This is not determined until the machine manufacturer creates the PLCE partition. Another advantage is that, in spite of the encryption, the data can be backed up from the control to a separate data medium (USB drive, network, e.g., through TNCremo) and later restored. You need not enter the password, but the data cannot be read until the keyword is supplied.

PLC window The CNC PILOT 640 can display PLC error messages in the dialog line during operation.

PLC soft keys The machine manufacturer can display his own PLC soft keys in the vertical soft-key row on the screen.

PLC positioning All closed-loop axes can also be positioned via the PLC. PLC positioning of the NC axes cannot be superimposed on NC positioning.

PLC axes Axes can be defined as PLC axes. They are programmed by means of M functions or OEM cycles. The PLC axes are positioned independently of the NC axes.

PLCdesign (accessory) PC software for PLC program development. The PC program **PLCdesign** can be used for easy creation of PLC programs. Extensive examples of PLC programs are included.

Functions:

- Easy-to-use text editor
- Menu-guided operation
- Programming of symbolic operands
- Modular programming techniques
- "Compiling" and "linking" of PLC source files
- Operand commenting, creation of the documentation file
- Comprehensive help system
- Data transfer between the PC and control
- Creation of PLC soft keys

Python OEM Process (software option 46)

The Python OEM Process software option gives the machine manufacturer a powerful tool for using a high-level, object-oriented programming language in the control (PLC). Python is an easy-to-learn script language supporting all necessary high-level language elements.

Python OEM Process can be used universally for machine functions and complex calculations, as well as to display special user interfaces. User-specific or machine-specific solutions can be efficiently implemented. Numerous libraries on the basis of Python and GTK are available, regardless of whether you want to create special algorithms for special functions, or separate solutions such as an interface for machine maintenance software.

The applications you create can be included via the PLC in the familiar PLC windows, or they can be displayed in separate free windows that can be expanded to the control's full screen size.

Simple Python scripts (e.g., for display masks) can also be executed without enabling the Python OEM Process software option (software option 46). Reserved for this function are 10 MB of dedicated memory. For more information, refer to the *Python in HEIDENHAIN Controls Technical Manual*.



PLC basic program

The PLC basic program serves as the basis for the adaptation of the control to the requirements of the respective machine model. It can be downloaded from the Internet. These essential functions are covered by the PLC basic program:

- | | |
|---------------------|---|
| General information | <ul style="list-style-type: none"> • Vertical PLC soft-key row • Support for various screen formats • Display and management of PLC error messages • Hydraulic control • Work envelope protection • Chuck protection • Chuck (inner and outer chucking for compression and tension fixtures) • Control of the coolant system (internal, external, air) • Handling of M functions • Chip conveyor • PLC support for handwheels • PLC log • Diagnostic screen (Python) • Python example applications • Status display is modifiable by the user in the dashboard area (Python widget) • Tailstock (coupled Z axis) with quill |
| System | <ul style="list-style-type: none"> • 3 channels for multi-slide machining • 5-axis machining milling/turning with B axis |
| Axes | <ul style="list-style-type: none"> • Control of analog and digital axes • Axes with clamping mode, central drive, and Hirth grid • Synchronized axes • Reference run, reference end position • Feed rate control • Axis lubrication • Temperature compensation |
| Spindles | <ul style="list-style-type: none"> • Control of analog and digital spindles (S1 to S5) • Spindle synchronism for main and counter spindles (S1/S4) • Torque reduction for workpiece transfer (SI/S4) • Oriented spindle stop • Spindles with clamping mode • Gear switching via M functions • C-axis operation of spindles (S1/S4) • C-axis operation via separate motor |
| Tool changers | <ul style="list-style-type: none"> • Manual tool changer • Tool change with multifix • Positioning of the tool turret with three-phase AC motor • Tool changer with revolver system (five types, multi-channel) • Tool changer with B axis, tool gripper, tool shuttle, and n tool magazines • Service functions for the tool changer (multi-channel) |
| Safety functions | <ul style="list-style-type: none"> • Functional safety (FS) • Emergency stop test (EN 13849-1) • Brake test (EN 13849-1) • Repeated switch-on test |

Interfacing to the machine

OEM cycles	<p>The machine manufacturer has the possibility of creating his own UNITS for programming in smart.Turn (menus, texts, dialogs, and evaluations). These UNITS can be called by a menu item in the UNIT menu.</p> <p>With the CNC PILOT 640 you can create your own manufacturer cycles (OEM G functions). The range G500 to G590 is intended for these G functions. They can be called via the G-function menu and integrated directly into the NC program.</p> <p>In addition to the OEM G functions, PLC G functions (G602 to G699) can also be defined. The PLC G functions are processed directly in the PLC.</p>
Tool management	<p>With integral PLC, the tool changer is moved either via proximity switch or as a controlled axis. Complete tool management with tool life monitoring and replacement tool monitoring is carried out by the CNC PILOT 640.</p>
Tool calibration	<p>With the TT tool touch probe systems (accessory), tools can be measured and inspected. Standard cycles for automatic tool measurement are available in the control. The control calculates the probing feed rate and the optimal spindle speed. The measured data are stored in a tool table.</p>
Touch-probe configuration	<p>All touch-probe data can be configured conveniently through a table. All HEIDENHAIN touch probe systems are preconfigured and can be selected through a drop-down menu.</p>
Magazine management	<p>The magazine management provides several functions for various magazine types:</p> <ul style="list-style-type: none">• Loading and unloading of tools in chain-type magazines• Loading and unloading between magazine and spindle• Support for manual tools in manual magazines• Support for block search in tool magazines

Data transfer and communication

Data interfaces

Overview	<p>The CNC PILOT 640 is connected to PCs, networks, and other data storage devices via data interfaces.</p>
Ethernet	<p>The CNC PILOT 640 can be interconnected via the Ethernet interface. For connection to a data network, the control features a 1000BASE-T (twisted pair Ethernet) connection.</p> <p>Maximum transmission distance: Unshielded: 100 m Shielded: 400 m</p>
Protocol	<p>The CNC PILOT 640 communicates using the TCP/IP protocol.</p>
Network connection	<ul style="list-style-type: none">• NFS file server• Windows networks (SMB)
Data transmission speed	<p>Approx. 400 to 800 Mbit/s (depending on the file type and network utilization)</p>
Protocols	<p>The CNC PILOT 640 can transfer data using various protocols.</p>
Standard data transmission	<p>The data is transferred character by character. The number of data bits, stop bits, the handshake, and character parity must be set by the user.</p>
Blockwise data transfer	<p>The data is transferred blockwise. A block check character (BCC) is used for data backup. This method improves data security.</p>
LSV2	<p>Bidirectional transfer of commands and data as per DIN 66019. The data is divided into telegrams (blocks) and transmitted.</p>
USB	<p>The CNC PILOT 640 features USB interfaces for connecting standard USB devices such as a mouse, disk drive, etc. The MC units have four USB 3.0 interfaces. One of them leads to the TE, where a cover cap protects it from contamination. More USB 2.0 ports are in the integrated USB hub on the rear of the BF. The USB ports are rated for a maximum of 0.5 A.</p>
USB cables	<p>Cable length of up to 5 m ID 354770-xx Cable length of 6 m to 30 m with integrated amplifier; limited to USB 1.1 ID 624775-xx</p>

Software for data transfer

We recommend using HEIDENHAIN software to transfer files between the CNC PILOT 640 and a PC.

TNCremo (accessory)

This PC software package supports the user in transmitting data from the PC to the control. This software implements blockwise data transfer with block check characters (BCC).

Functions:

- Data transfer (including blockwise)
- Remote control (only serial)
- File management and data backup of the control
- Reading out the log
- Print-out of screen contents
- Text editor
- Managing more than one machine

TNCremoPlus (accessory)

In addition to the features already familiar from TNCremo, TNCremoPlus can also transfer the current content of the control's screen to the PC (live screen). This makes it very simple to monitor the machine.

Additional functions:

- Interrogation of control information (NC uptime, machine uptime, machine running time, spindle running time, pending errors, data from the data servers—e.g., symbolic PLC operands)
- Overwriting of specific tool data based on values from a tool presetter

TNCremoPlus

ID 340447-xx

Connected Machining

Overview

Connected Machining makes uniformly digital job management possible in networked manufacturing. You also profit from:

- Easy data usage
- Time-saving procedures
- Transparent processes

Remote Desktop Manager (software option 133)

Remote control and display of external computers over an Ethernet connection (e.g., Windows PC). The information is displayed on the control's screen. Remote Desktop Manager allows you to access important applications, such as CAD/CAM applications or job management, from the control.

Remote Desktop Manager

ID 894423-xx

HEIDENHAIN DNC (software option 18)

The development environments on Windows operating systems are particularly well suited as flexible platforms for application development in order to handle the increasingly complex requirements of the machine's environment.

The flexibility of the PC software and the large selection of ready-to-use software components and standard tools in the development environment enable you to develop PC applications of great use to your customers in a very short time, for example:

- Error reporting systems that, for example, send the customer a text message to his cell phone reporting problems on the currently running machining process
- Standard or customer-specific PC software that decidedly increases process reliability and equipment availability
- Software solutions controlling the processes of manufacturing systems
- Information exchange with job management software

The HEIDENHAIN DNC software interface is an attractive communication platform for this purpose. It provides all the data and configuration capabilities needed for these processes so that an external PC application can evaluate data from the control and, if required, influence the manufacturing process.

RemoTools SDK (accessory)

To enable you to use HEIDENHAIN DNC effectively, HEIDENHAIN offers the RemoTools SDK development package. It contains the COM component and the ActiveX control for integration of the DNC functions in development environments.

RemoTools SDK

ID 340442-xx

For more information, refer to the *HEIDENHAIN DNC* brochure.

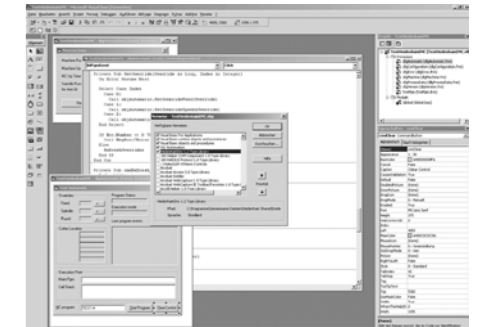
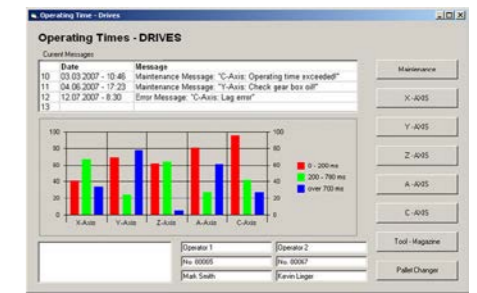

Mounting information

Clearances and mounting

Proper minimum clearance

When mounting the control components, please observe proper minimum clearances and space requirements, as well as the length and position of the connecting cables.

Installation in an electrical cabinet

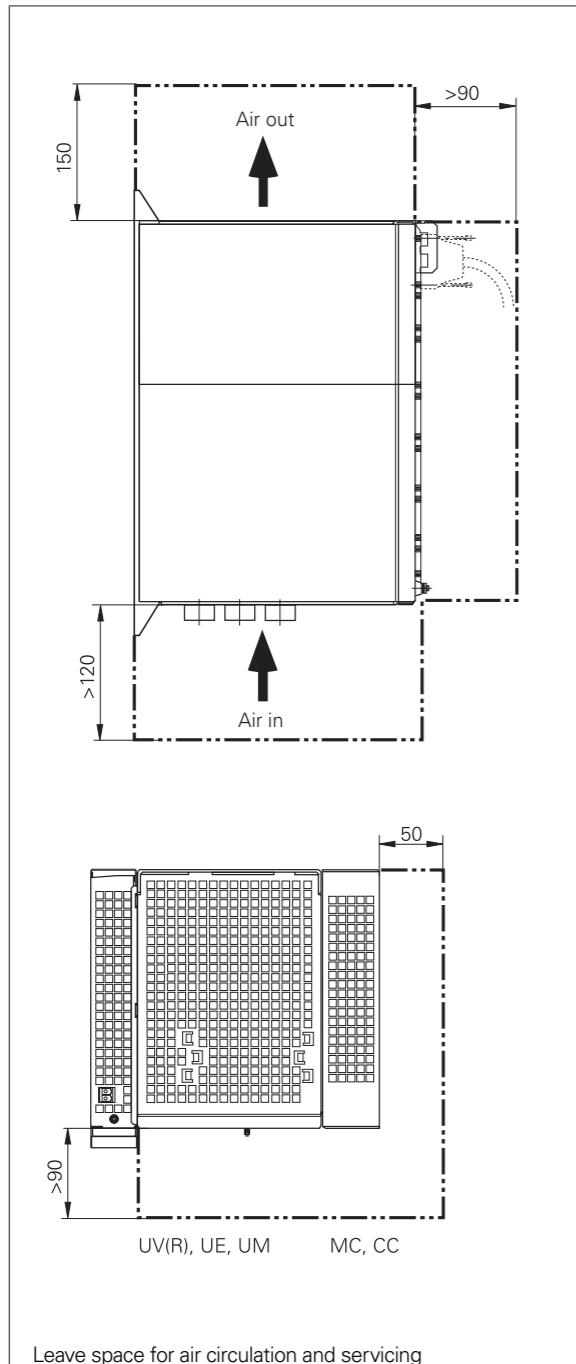

Installation in an operating panel

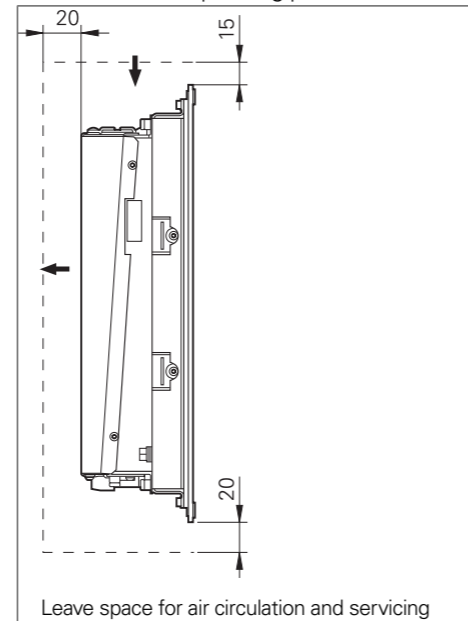

Mounting and electrical installation

Observe the following points during mounting and electrical connection:

- National regulations for low-voltage installations at the operating site of the machine or components
- National regulations regarding interference and noise immunity at the operating site of the machine or components
- National regulations regarding electrical safety and operating conditions at the operating site of the machine or components
- Specifications for the installation position
- Specifications of the Technical Manual

Degrees of protection

The following components fulfill the requirements for IP54 (dust protection and splash-proof protection):

- Display unit (when properly installed)
- Keyboard unit (when properly installed)
- Machine operating panel (when properly installed)
- Handwheel

All electric and electronic control components must be installed in an environment (e.g., electrical cabinet, housing) with an IP54 rating (dust and splash-proof protection) in order to fulfill the requirements of pollution degree 2. All components of the OEM operating panel must also have an IP54 rating, just like the HEIDENHAIN operating panel components.

Electromagnetic compatibility

Protect your equipment from interference by observing the rules and recommendations specified in the Technical Manual.

Intended place of operation

This unit fulfills the requirements of EN 50370-1 and is intended for operation in industrially zoned areas.

Likely sources of interference

Interference is produced by capacitive and inductive coupling into electrical conductors or into device connections, caused by, e.g.:

- Strong magnetic fields from transformers or electric motors
- Relays, contactors, and solenoid valves
- High-frequency equipment, pulse equipment, and stray magnetic fields from switch-mode power supplies
- Power lines and leads to the above equipment

Protective measures

- Ensure that the MC, CC, and signal lines are at least 20 cm away from interfering devices
- Minimum distance of 10 cm between MC, CC, and signal lines to cables carrying interfering signals (in metal cable ducts, a grounded separation wall suffices for decoupling)
- Shielding according to EN 50178
- Use equipotential bonding lines in accordance with the grounding diagram (comply with the Technical Manual of your control).
- Use only genuine HEIDENHAIN cables and connecting elements

Installation elevation

The maximum elevation for installation of HEIDENHAIN control components (MC, CC, PLB, MB, TE, BF, IPC, etc.) is 3000 m above sea level.

Key dimensions

Main computer

MC 306, IPC 306

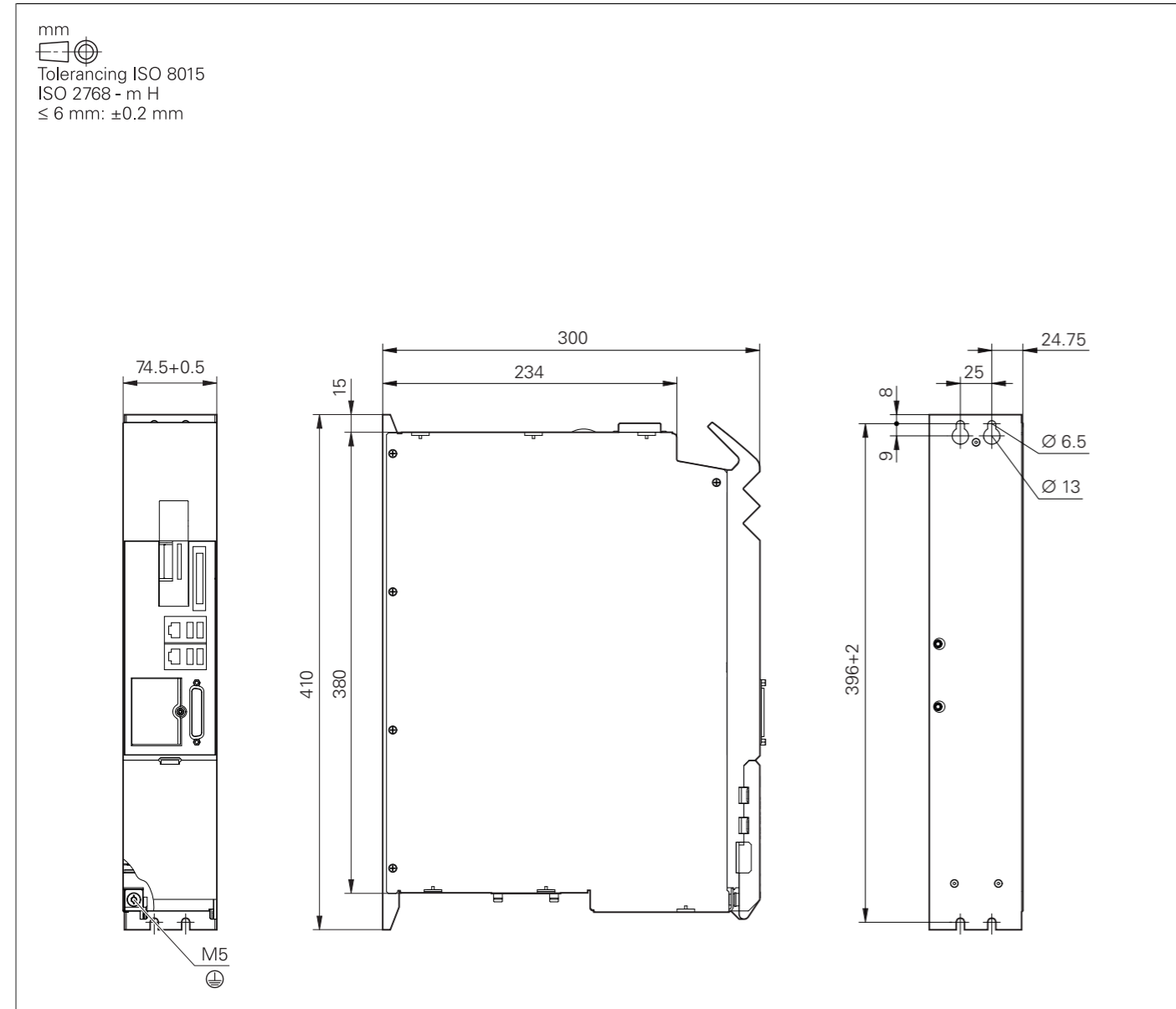

IPC 6641

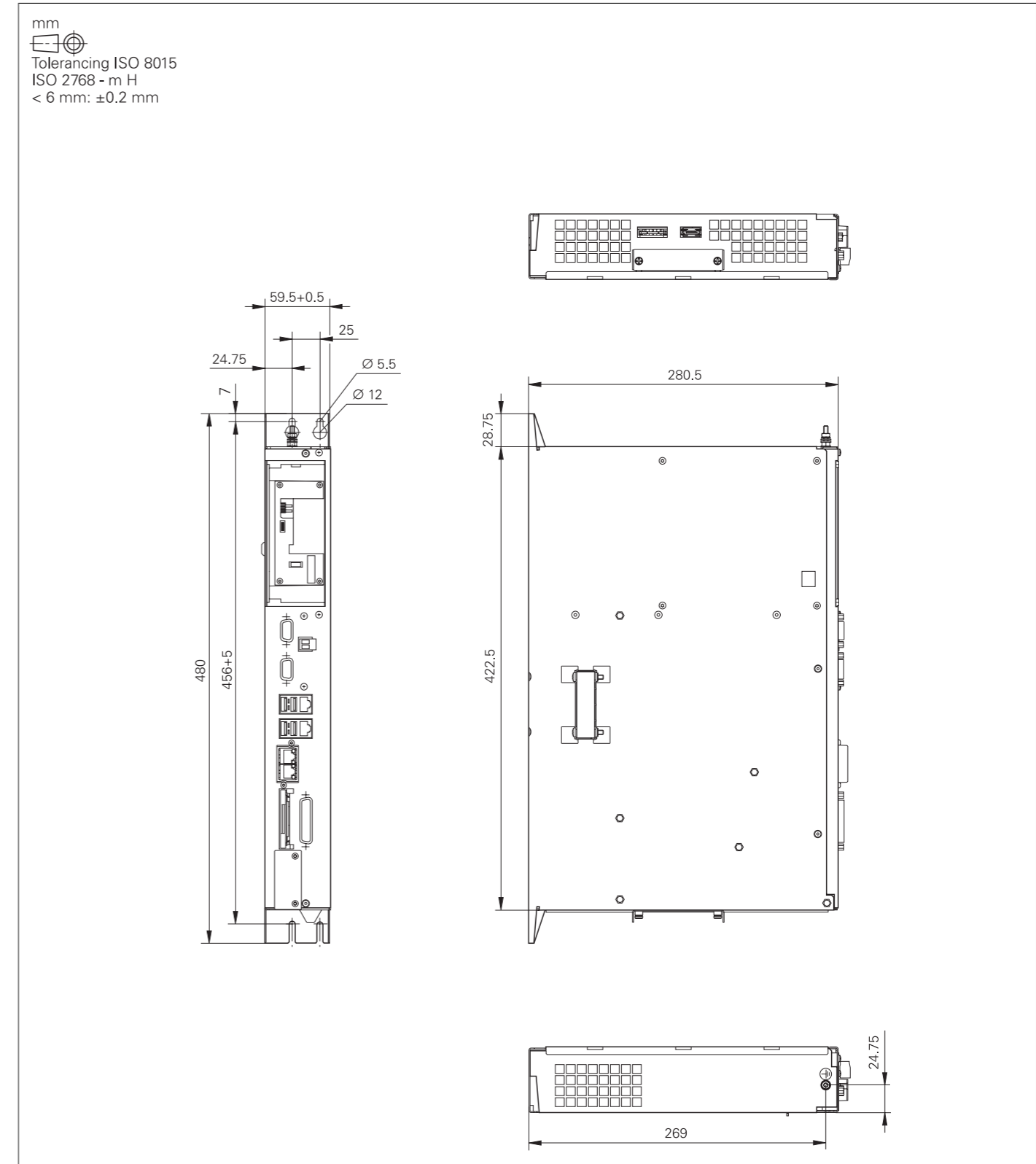

MC 8420T, IPC 8420

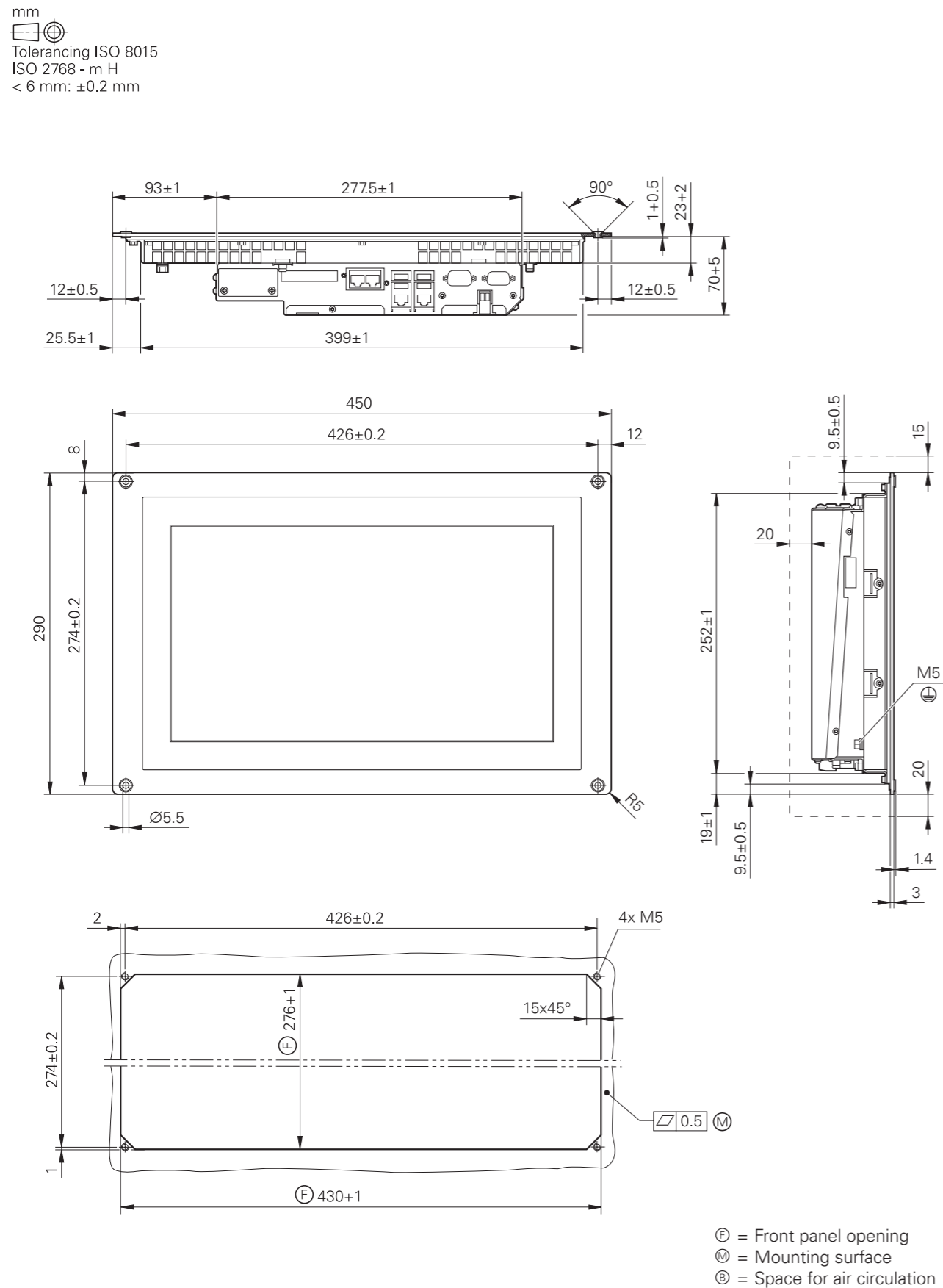

MC 366

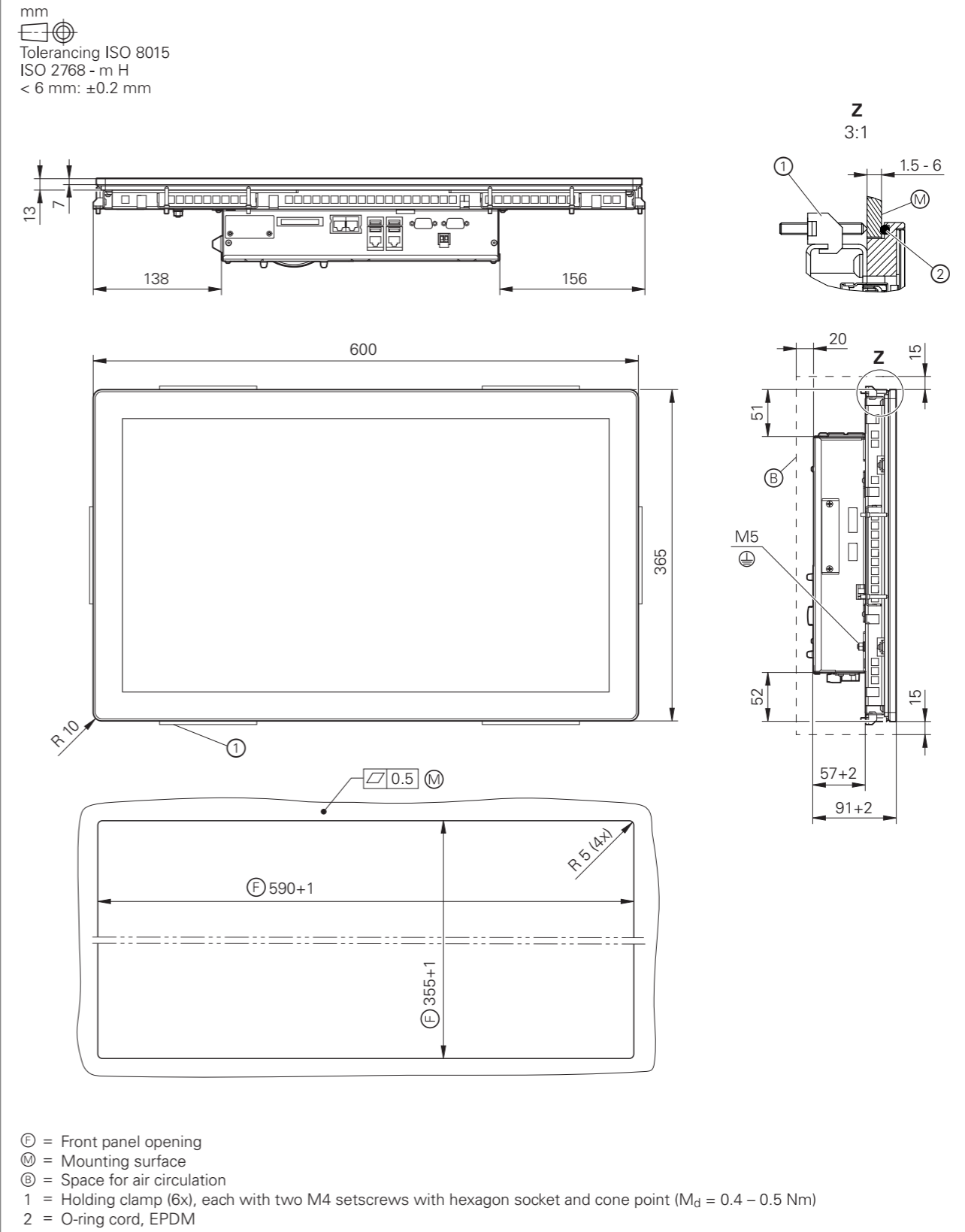

Display and keyboard

BF 860, ITC 860

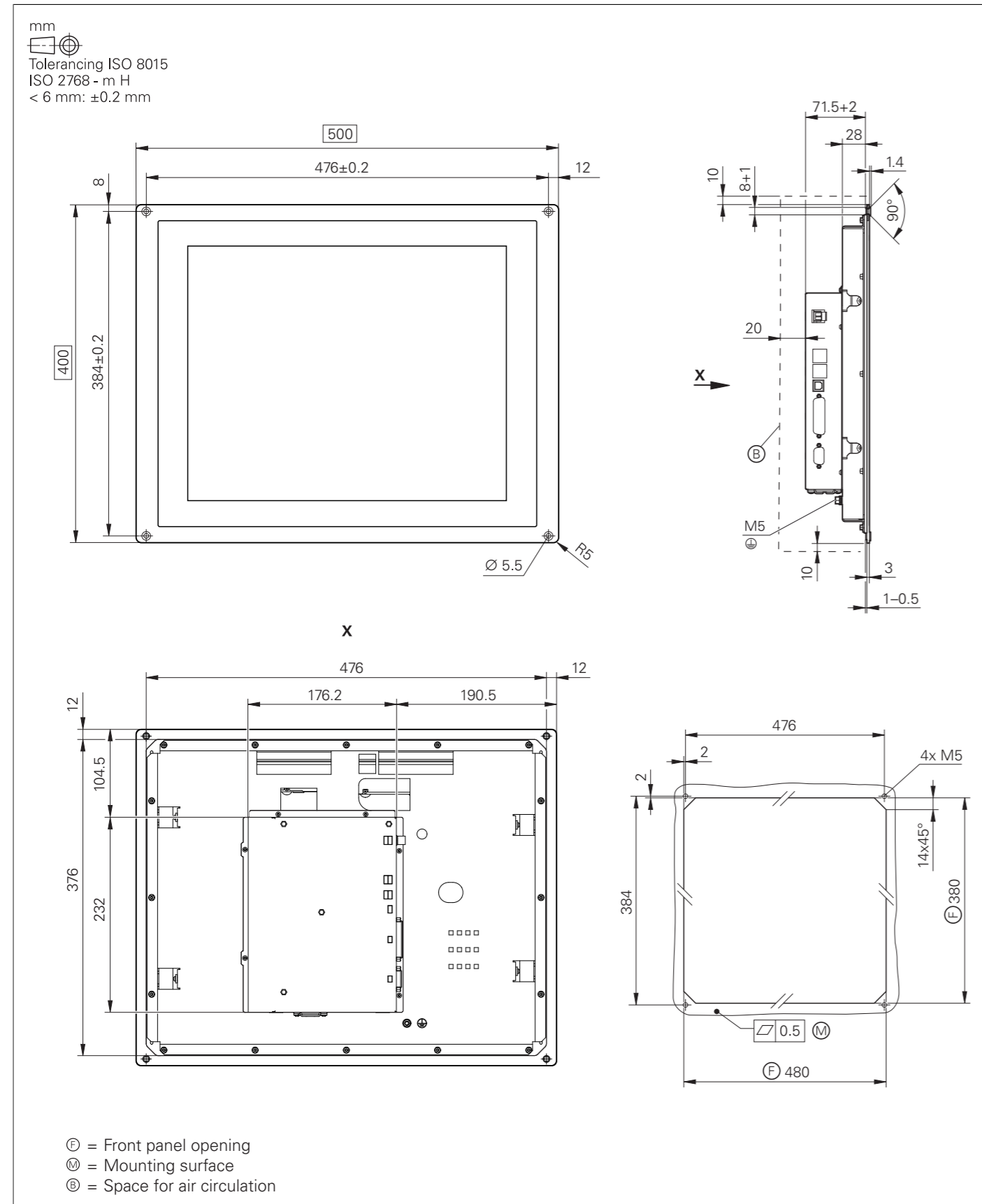

BF 360

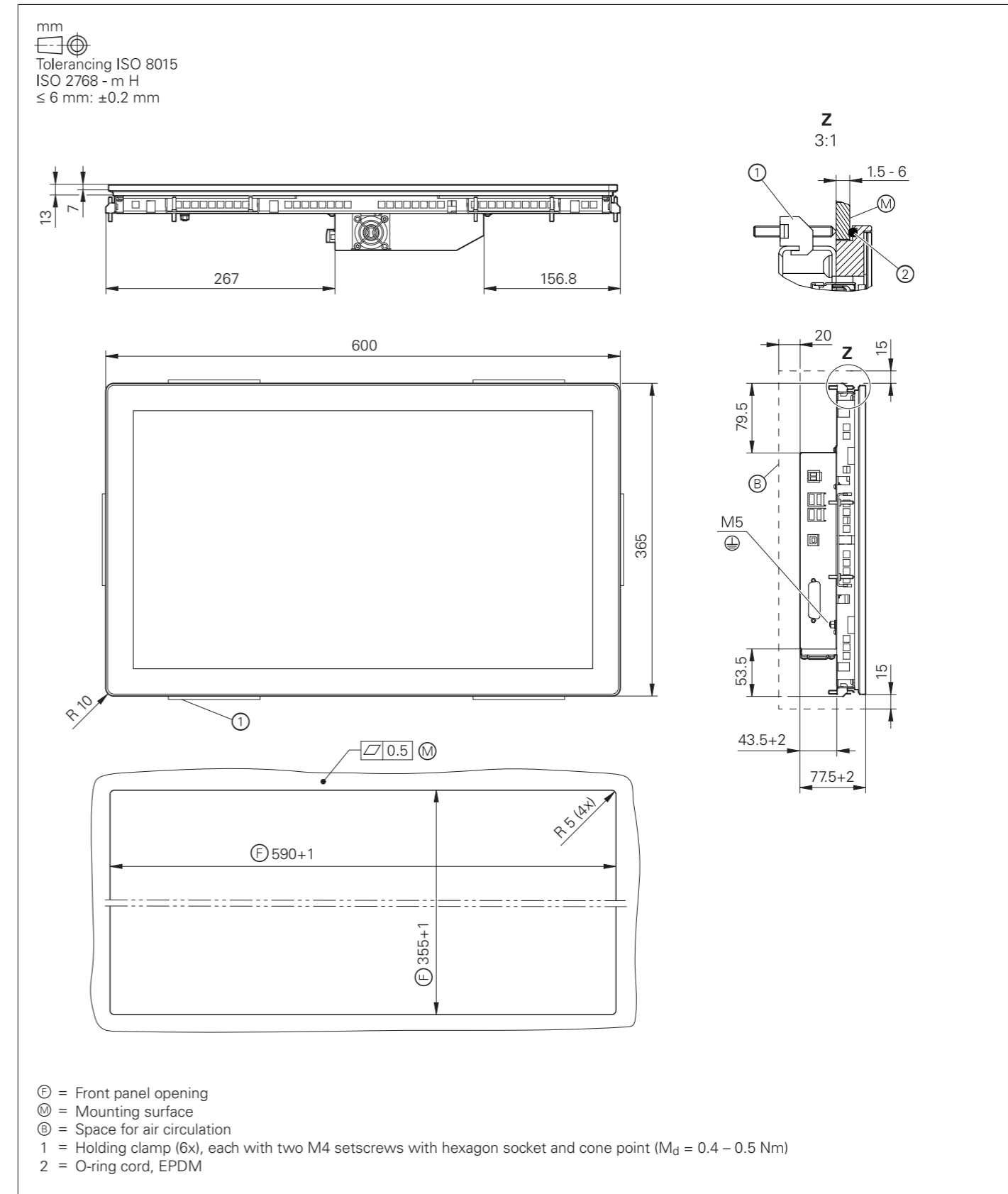

TE 745T

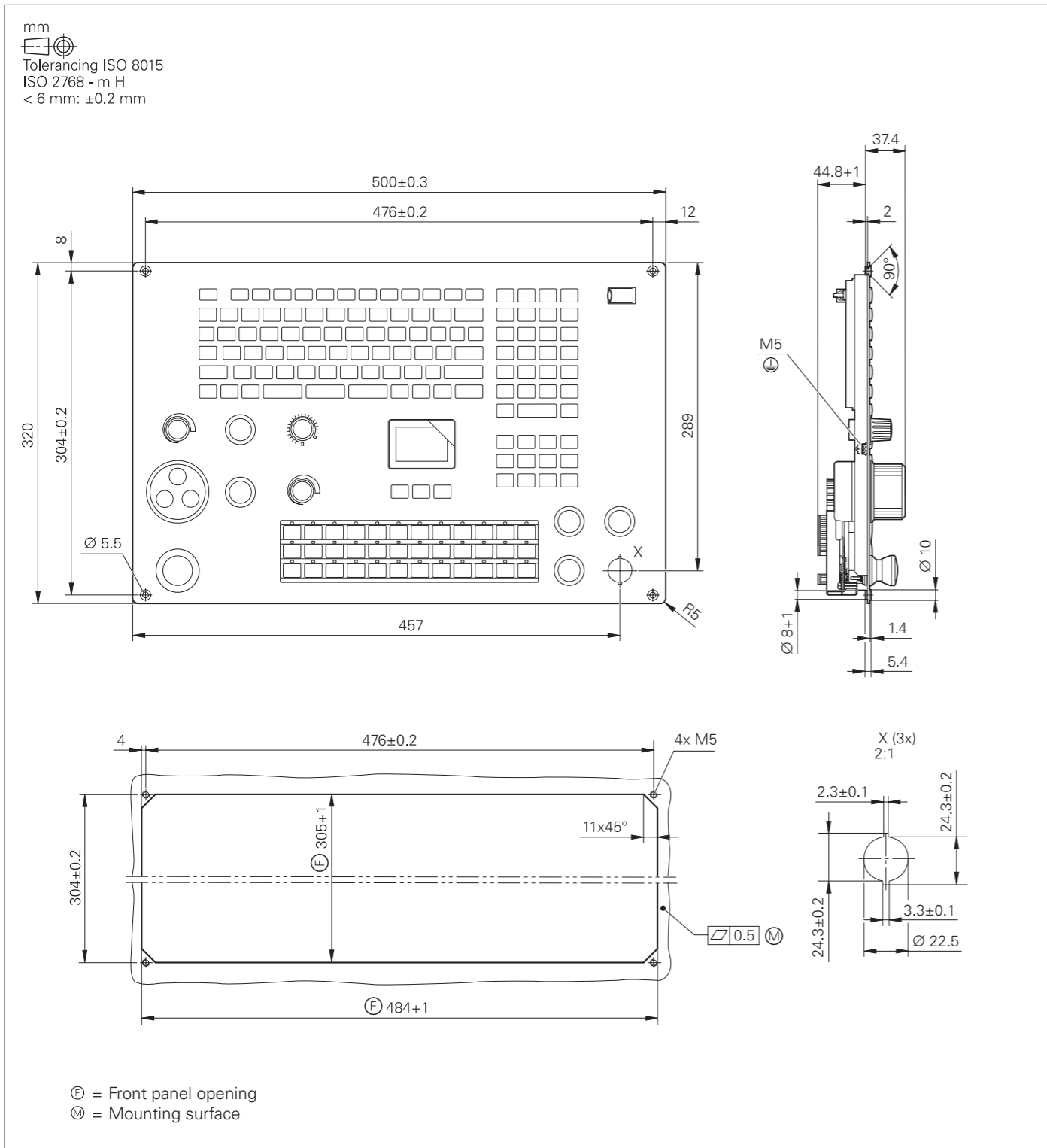

TE 725T, TE 725T FS

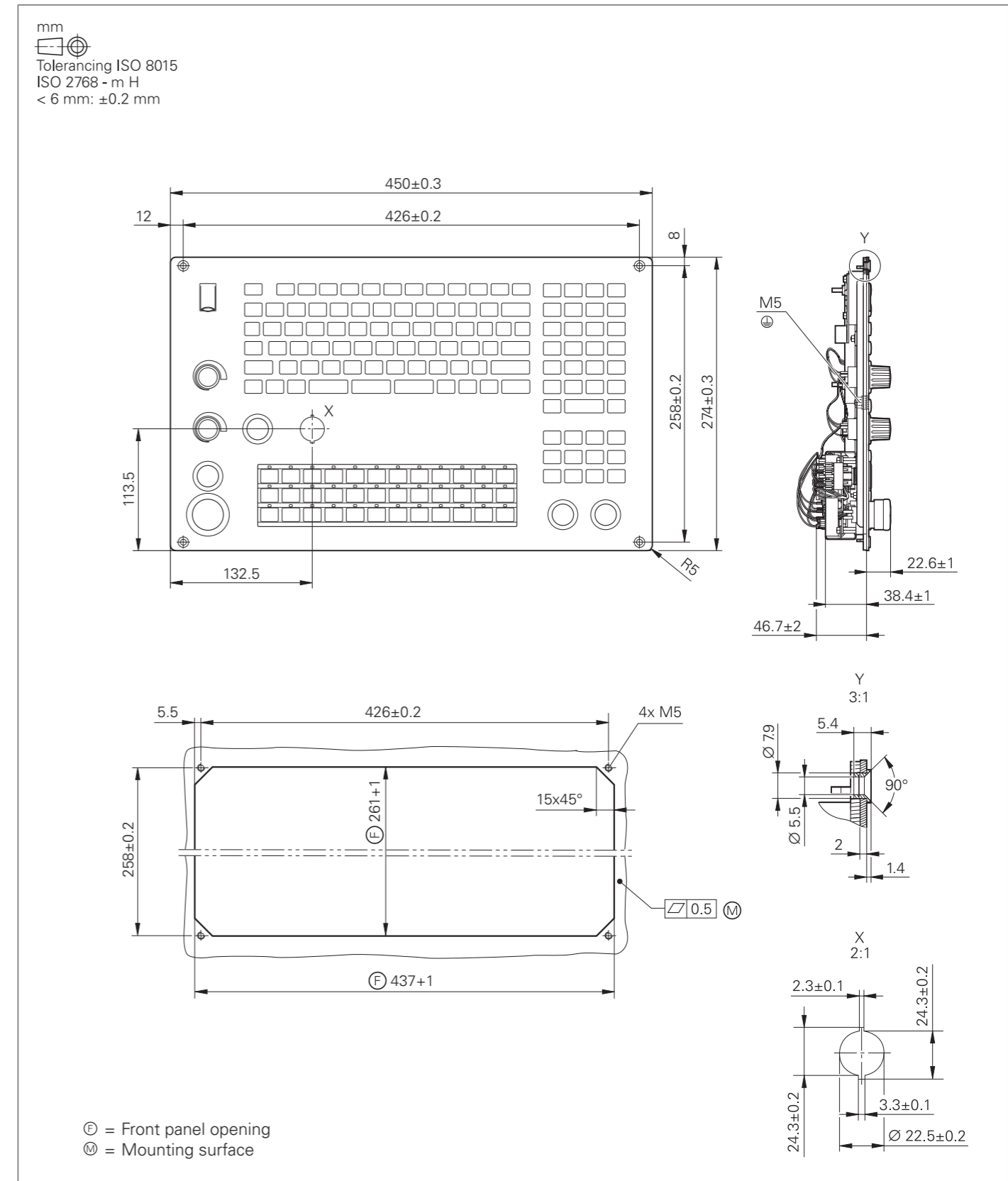

PLC inputs and outputs

PLB 6001, PLB 600x FS

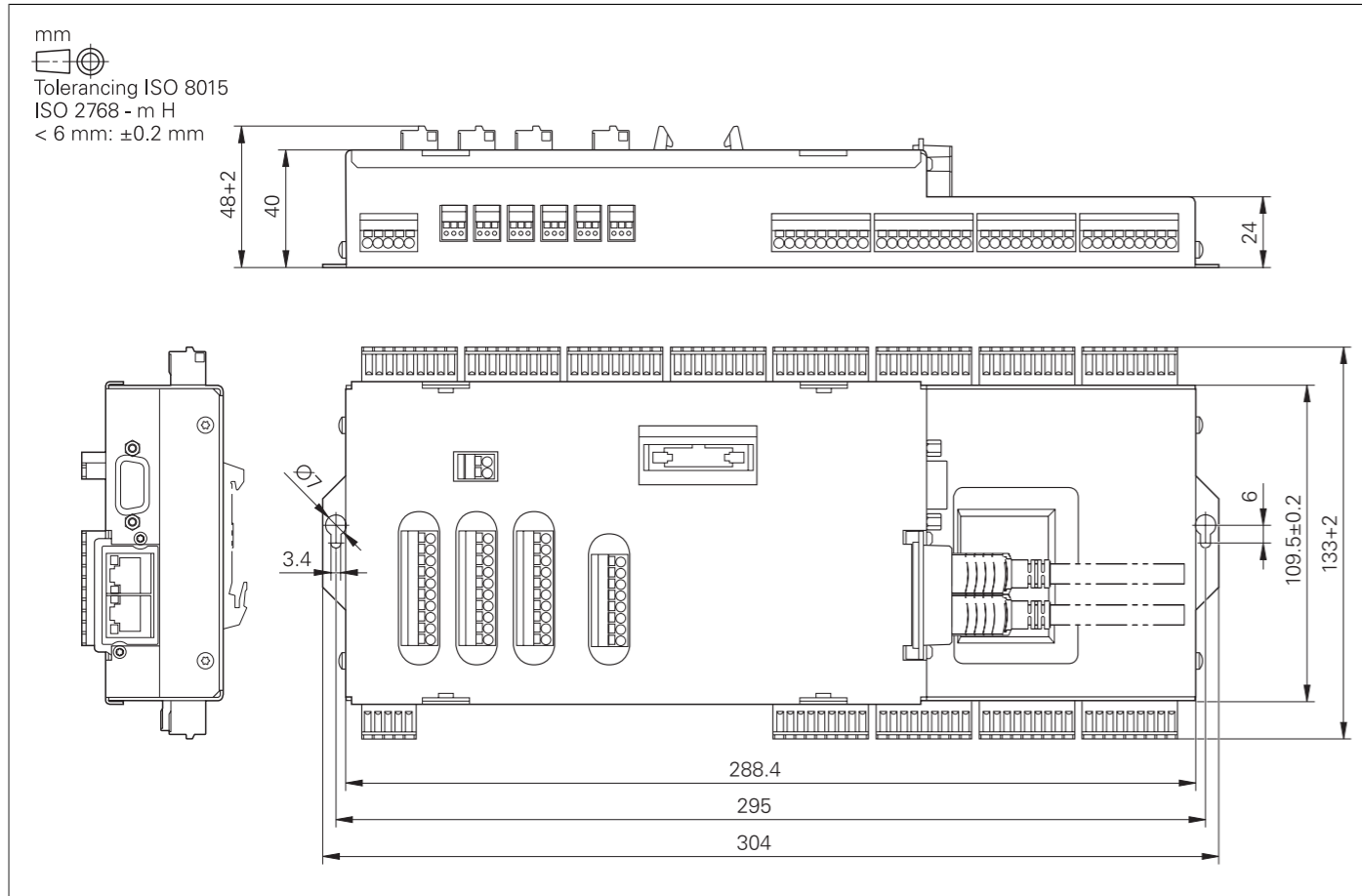

PL 6000 (PLB 62xx, PLB 61xx)

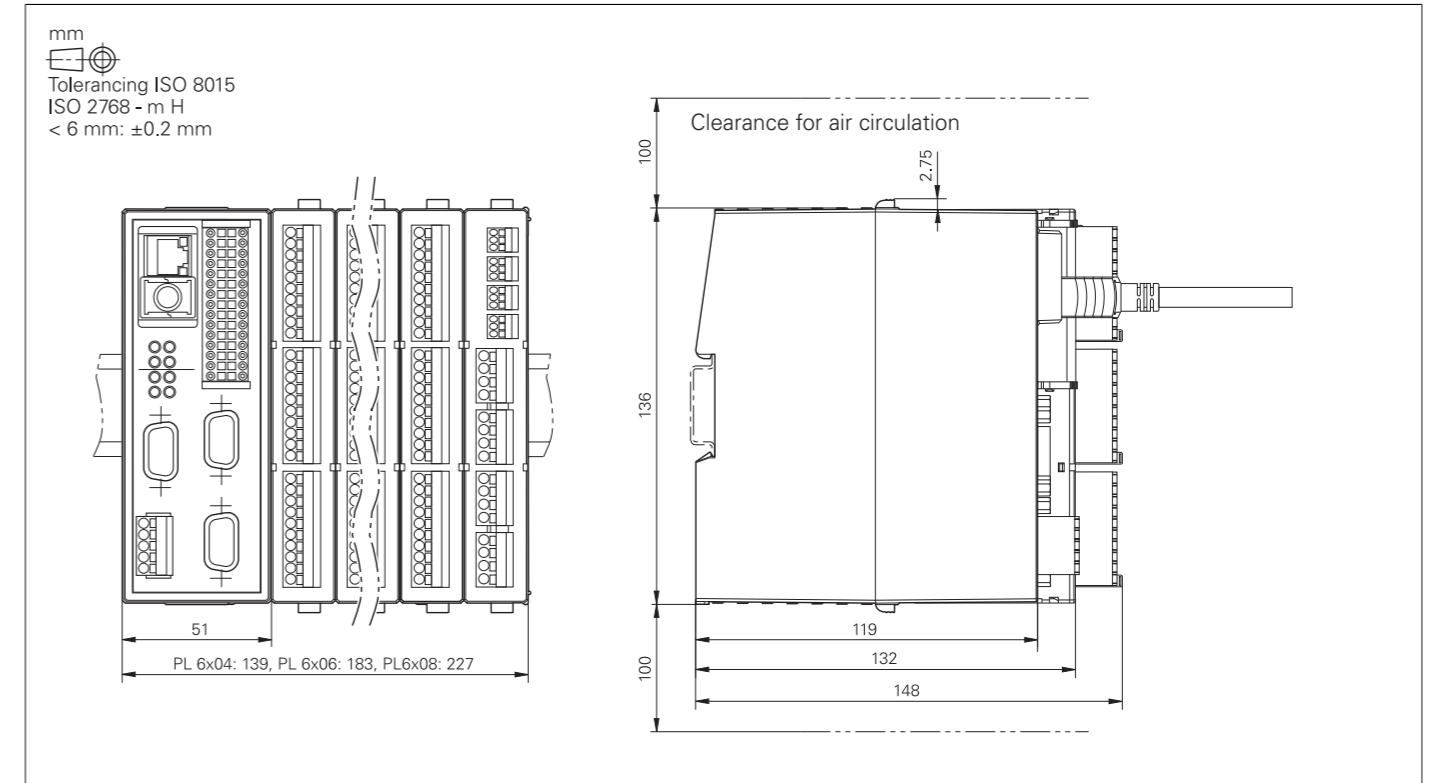

Electronic handwheels

HR 510, HR 510 FS

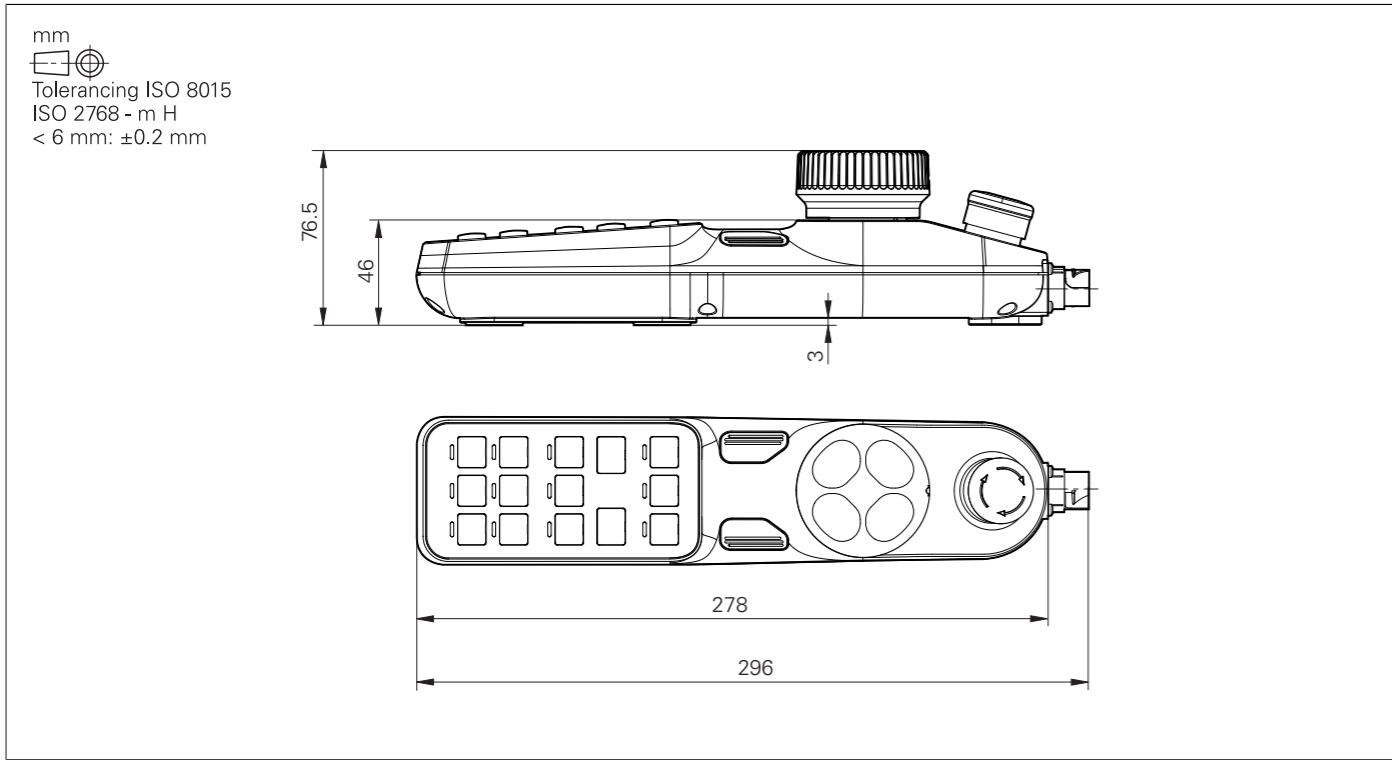

HR 520, HR 520 FS

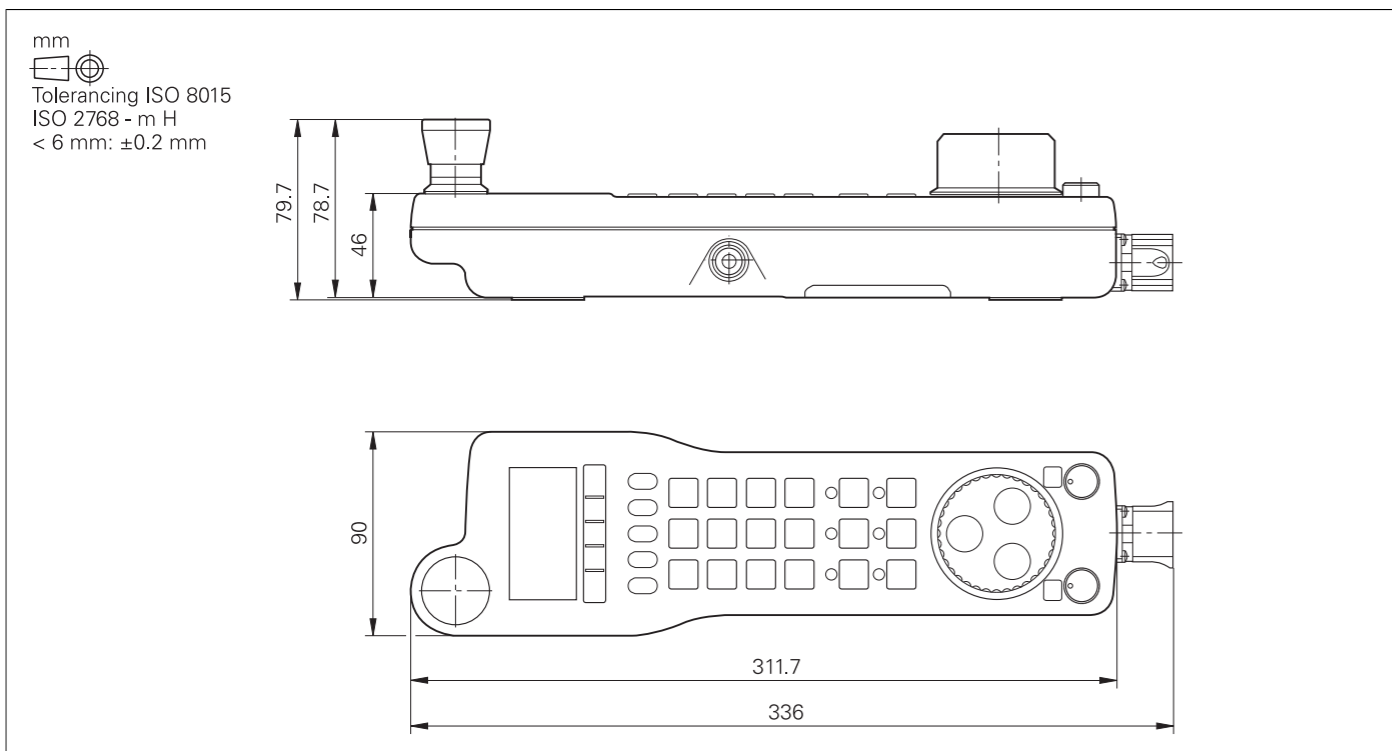

Holder for HR 520, HR 520 FS

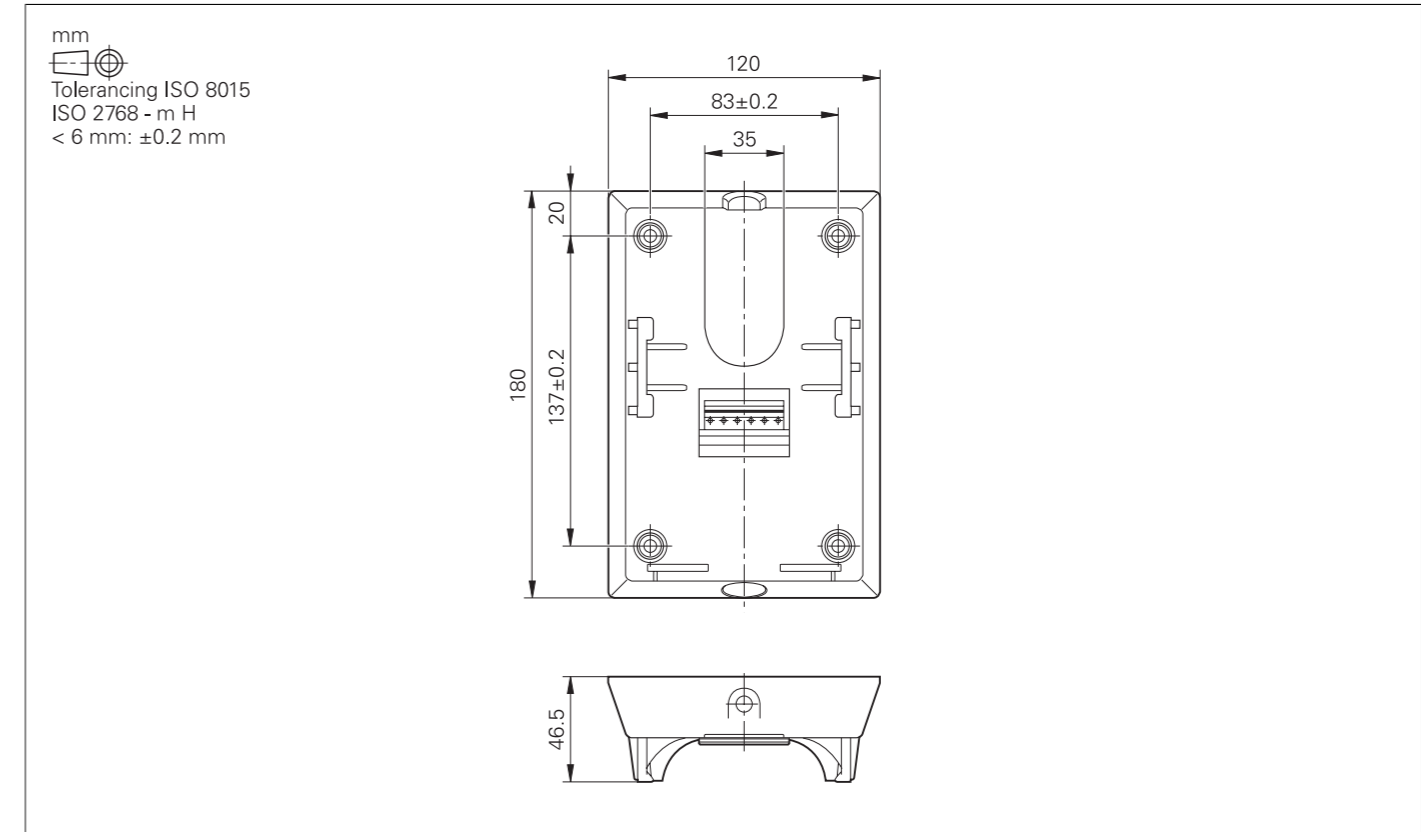

HR 550 FS

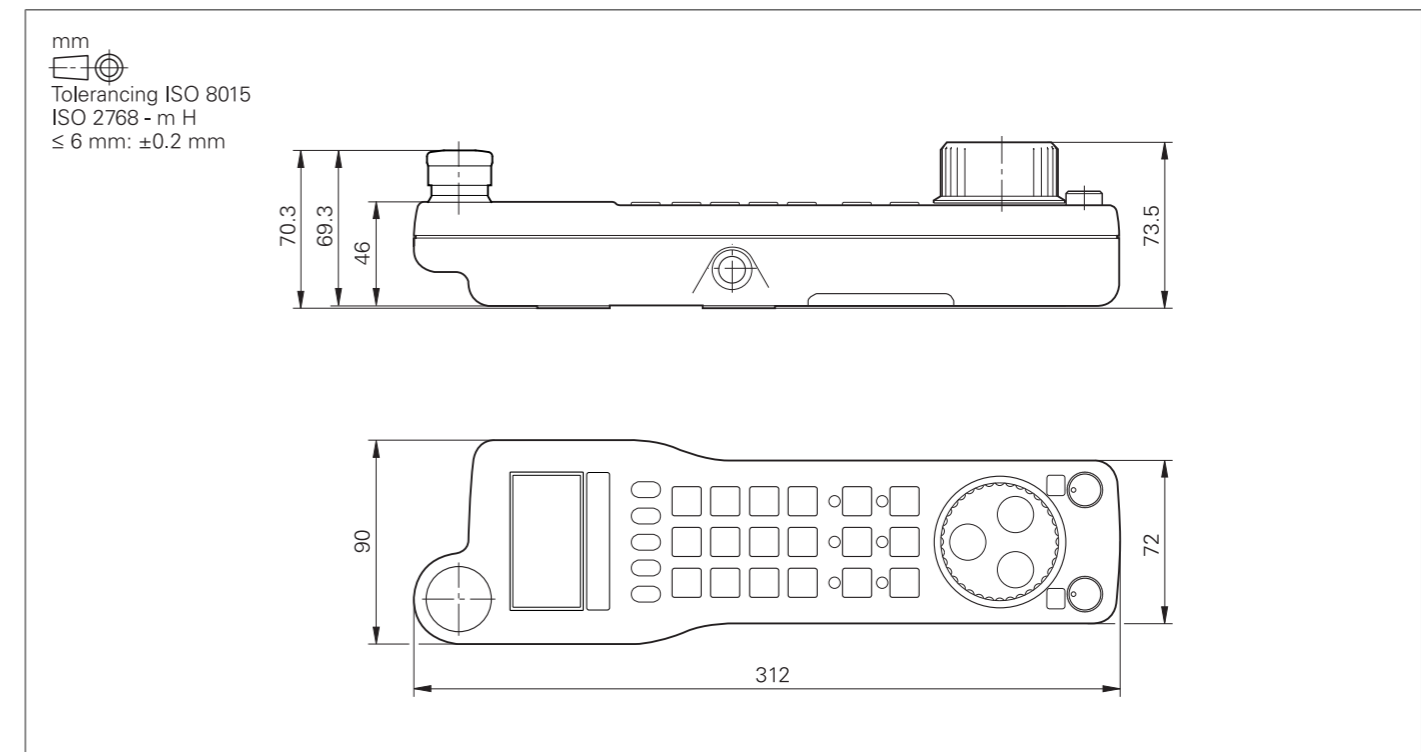

HRA 551 FS

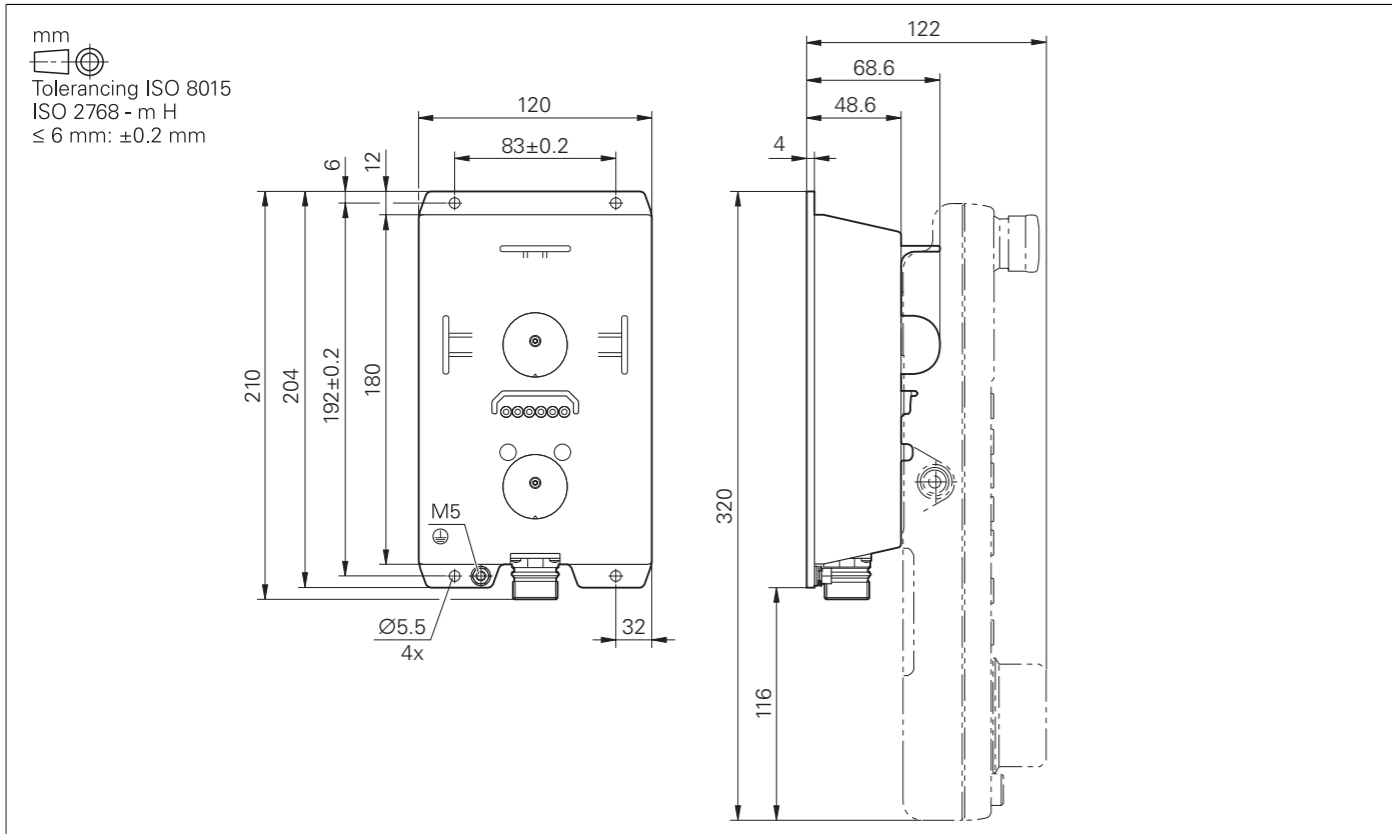

HR 130

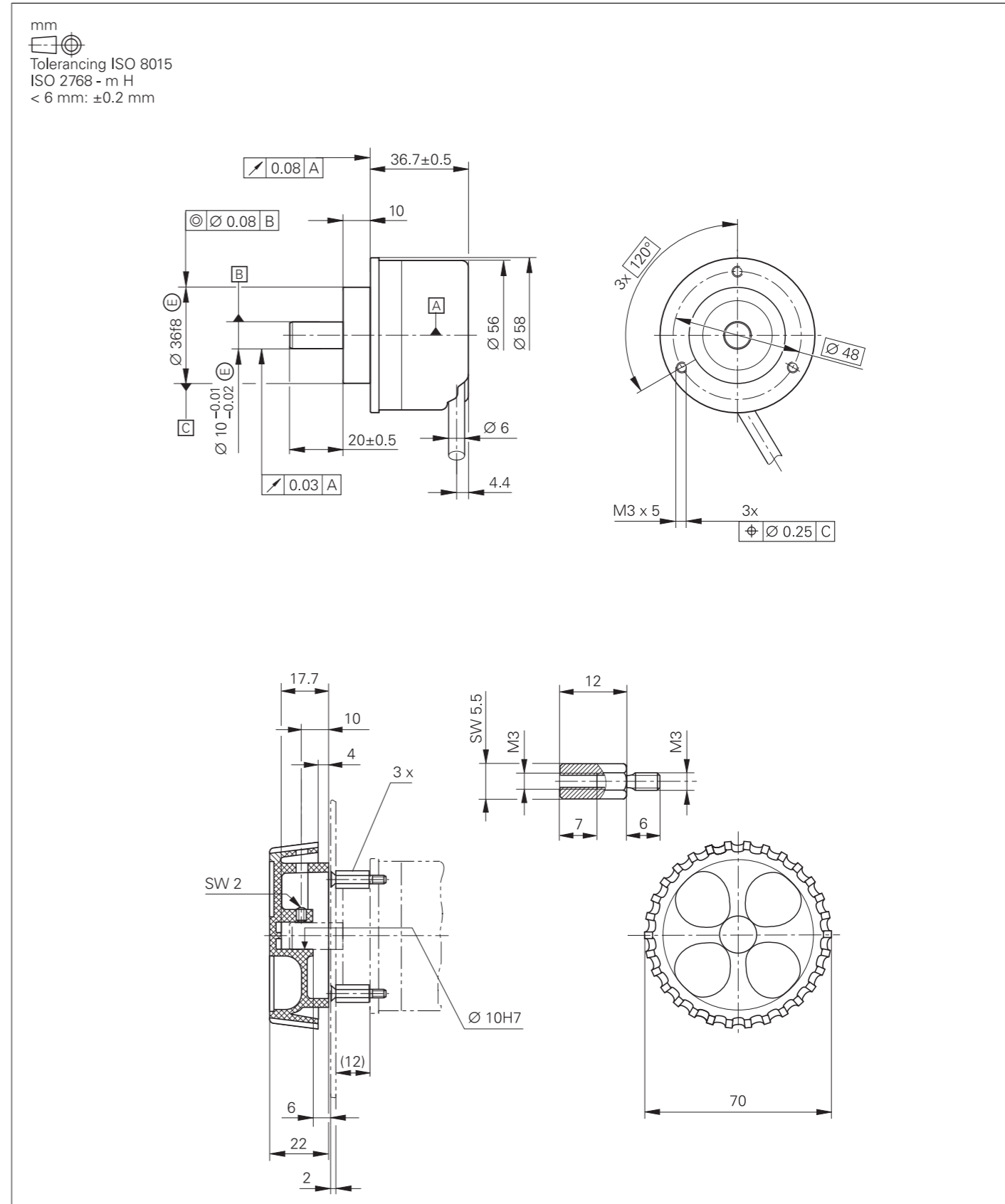

Adapter cable for handwheels (straight)

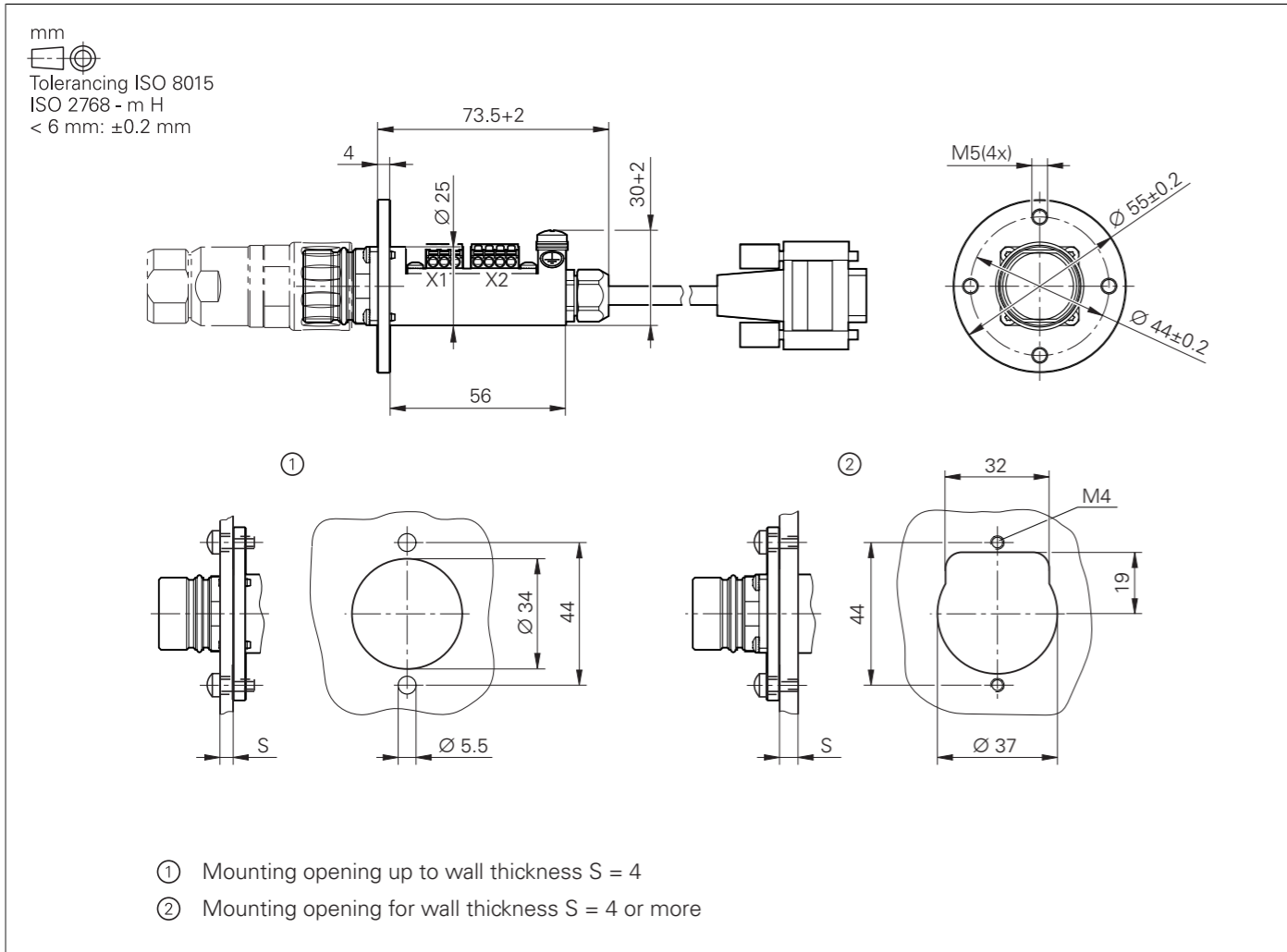

HR/HRA adapter cable to MC (straight connector)

Adapter cable for handwheels (angled)

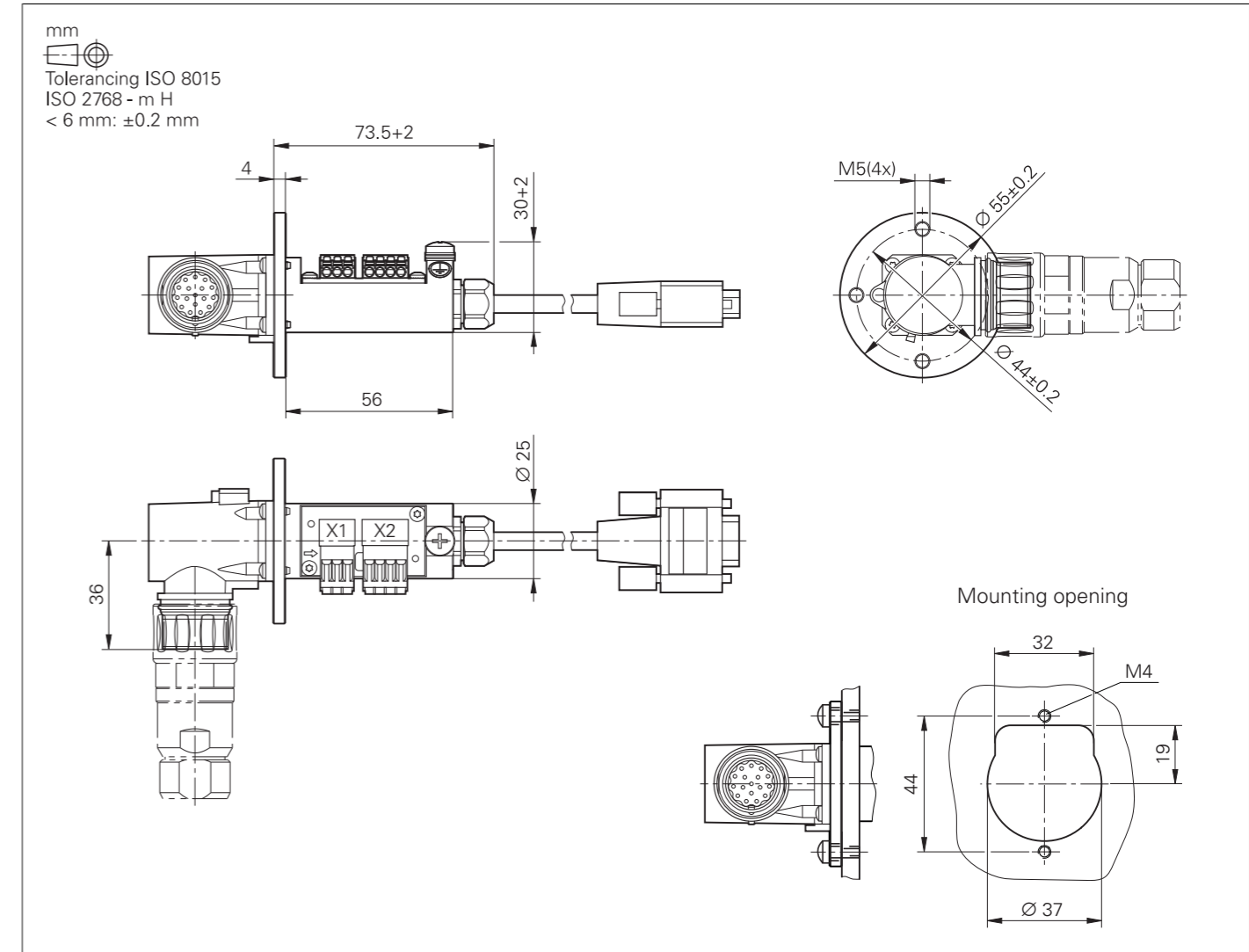

Adapter cable for HR/HRA to MC (angled connector)

Interface accessories

Line-drop compensator for encoders with EnDat interface

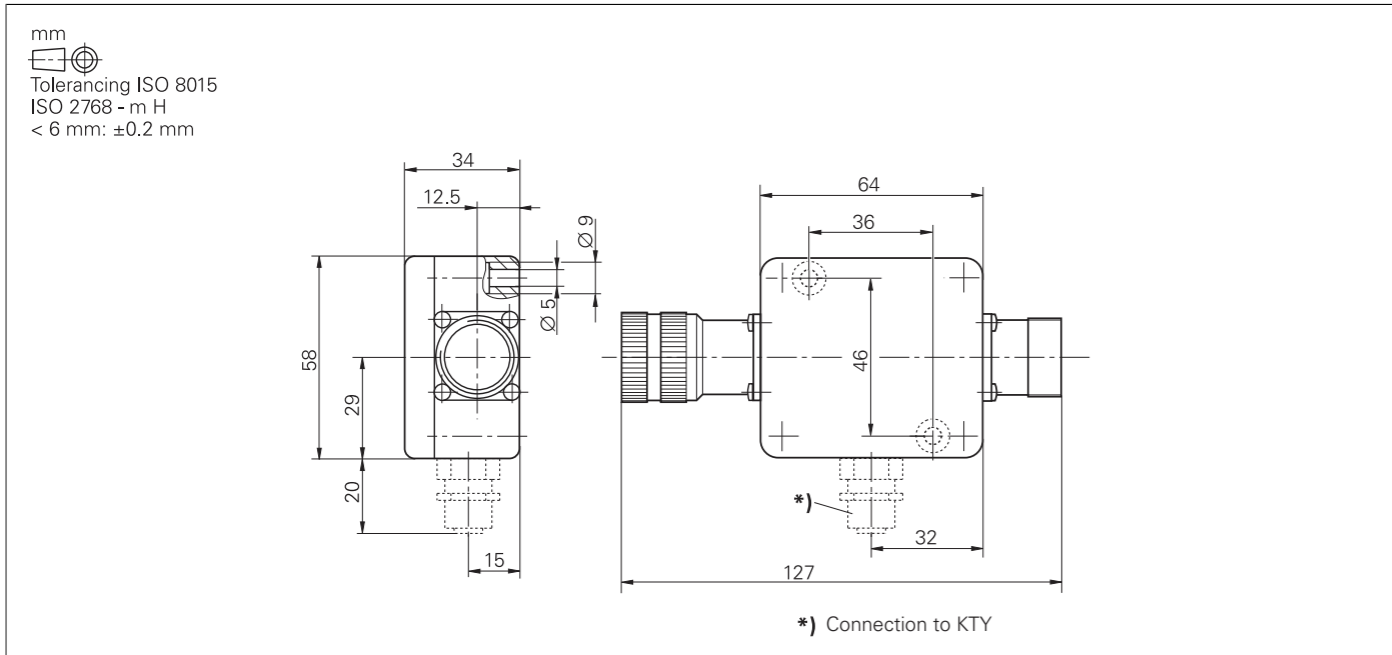

USB extension cable with hubs

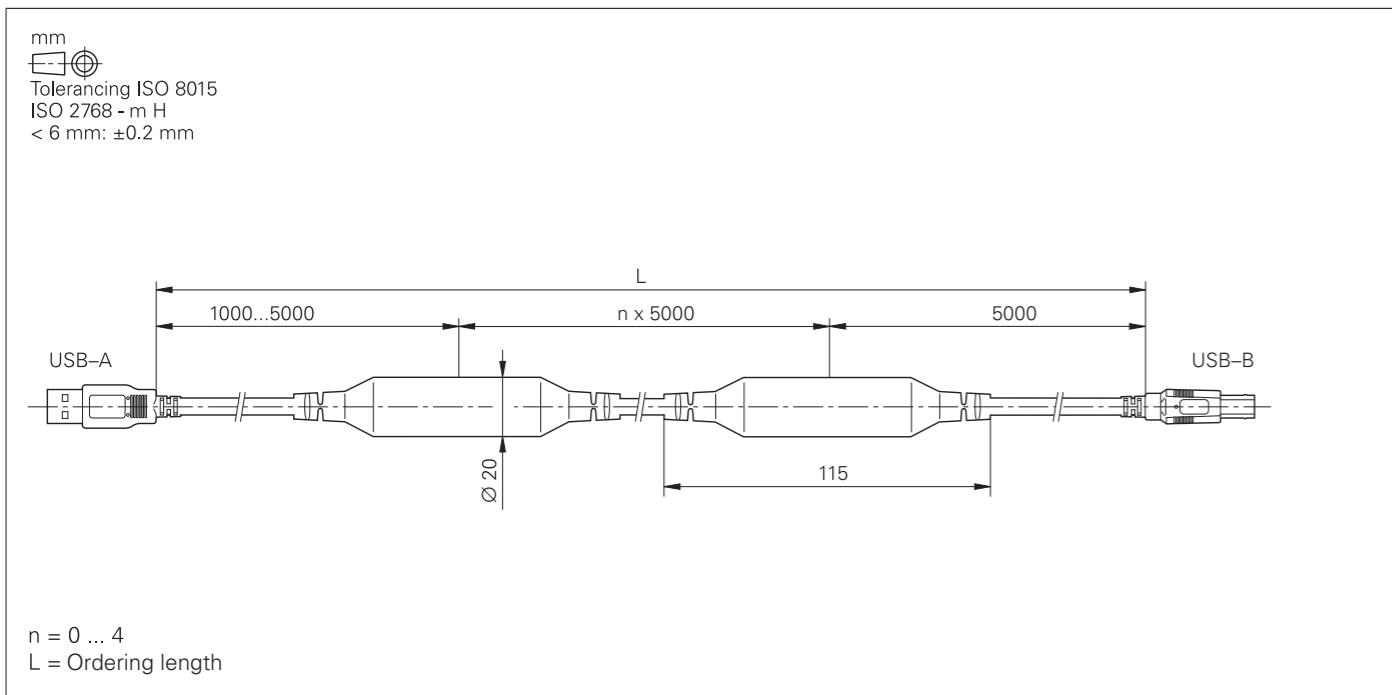

KTY adapter connector

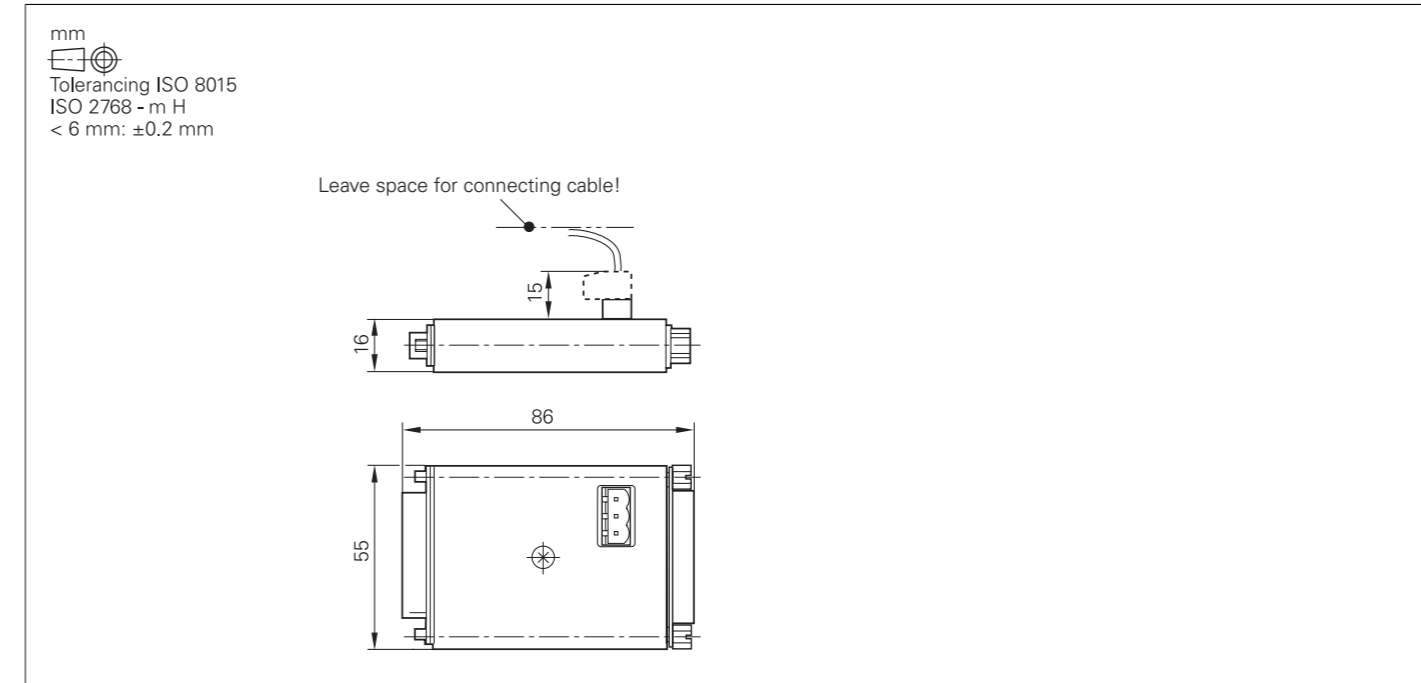

General information

Documentation

Technical documentation	<p>Technical Manuals (PDF format on HESIS-Web including Filebase)</p> <ul style="list-style-type: none"> • CNC PILOT 640 ID 1090006 • PNC 610 ID 1191125 • 1xx Inverter Systems ID 208962 • Gen 3 Drives ID 1252650 • Functional Safety (FS) ID 749363 • Functional Safety (FS) Supplement to the Technical Manual ID 1177599 • Python in HEIDENHAIN Controls ID 757807
User documentation	<p>User's Manuals</p> <ul style="list-style-type: none"> • CNC PILOT 640 ID 1079662-xx • smart.Turn and DIN (ISO) Programming ID 1118606-xx <p><i>General</i></p> <ul style="list-style-type: none"> • TNCremo Integrated help • TNCremoPlus Integrated help • IOconfig Integrated help • PLCdesign Integrated help
Other documentation	<p>Brochures</p> <ul style="list-style-type: none"> • CNC PILOT 640 ID 895949-xx • Functions of the CNC PILOT 640 ID 1224137-xx • Touch Probes ID 1113984-xx • Gen 3 Drives 527ID 1303180-xx • Motors ID 208893-xx • RemoTools SDK virtualTNC ID 628968-xx • Programming Station for Lathe Controls ID 826688-xx <p>Product Information documents</p> <ul style="list-style-type: none"> • HR 550 FS 527ID 636227-xx <p>Product Overviews</p> <ul style="list-style-type: none"> • Remote Diagnosis with TeleService ID 348236-xx <p>DVDs</p> <ul style="list-style-type: none"> • Touch Probes ID 344353-xx • Programming Station: DataPilot CP 640, MP 620 (Demo Version) ID 1230525-xx • Programming Station: DataPilot CP 640, MP 620 (Single Station License) ID 1230536-xx • Programming Station: DataPilot CP 640, MP 620 (Network License for 14 Stations) ID 1230537-xx • Programming Station: DataPilot CP 640, MP 620 (Network License for 20 Stations) ID 1230538-xx
Safety parameters	<p>For HEIDENHAIN products (such as control components, encoders, or motors), the safety characteristics (such as failure rates or statements on fault exclusion) are available on product-specific request from your HEIDENHAIN contact person.</p>
Basic circuit diagram	<p>More information on basic circuit diagrams can be requested from your HEIDENHAIN contact person.</p>

Service and training

Technical support	<p>HEIDENHAIN offers the machine manufacturer technical support to optimize the adaptation of the control to the machine, including on-site support.</p>				
Exchange control	<p>In the event of a malfunction, HEIDENHAIN guarantees the timely shipment of an exchange control (usually within 24 hours in Europe).</p>				
Helpline	<p>Our customer service technicians are available for questions regarding adaption or in the event of malfunctions:</p> <p>NC support +49 8669 31-3101 (initial configuration/optimization, field service/troubleshooting) E-mail: service.nc-support@heidenhain.de</p> <p>PLC/Python programming +49 8669 31-3102 Functional safety (FS) E-mail: service.plc@heidenhain.de</p> <p>NC/Cycle programming and kinematics +49 8669 31-3103 E-mail: service.nc-pgm@heidenhain.de</p> <p>Encoders / machine calibration +49 8669 31-3104 E-mail: service.ms-support@heidenhain.de</p> <p>Application programming +49 8669 31-3106 E-mail: service.app@heidenhain.de</p> <p>If you have questions about repairs, spare parts, or exchange units, please contact our Service department:</p> <p>Customer service, Germany +49 8669 31-3121 E-mail: service.order@heidenhain.de</p> <p>Customer service, international +49 8669 31-3123 E-mail: service.order@heidenhain.de</p>				
Machine calibration	<p>On request, HEIDENHAIN engineers will calibrate your machine's geometry (e.g., with a KGM grid encoder).</p>				
Technical courses	<p>HEIDENHAIN provides technical customer training in the following subjects:</p> <ul style="list-style-type: none"> • NC programming • PLC programming • TNC optimization • TNC servicing • Encoder servicing • Special training for specific customers <p>For more information on dates or registration:</p> <table border="1" style="width: 100%; border-collapse: collapse;"> <tr> <td style="padding: 2px;">Technical training courses in Germany</td> <td style="padding: 2px;">+49 8669 31-3049 E-mail: mtt@heidenhain.de</td> </tr> <tr> <td style="padding: 2px;">Technical training courses outside of Germany</td> <td style="padding: 2px;">www.heidenhain.com EN ► Service & Support ► Technical training</td> </tr> </table>	Technical training courses in Germany	+49 8669 31-3049 E-mail: mtt@heidenhain.de	Technical training courses outside of Germany	www.heidenhain.com EN ► Service & Support ► Technical training
Technical training courses in Germany	+49 8669 31-3049 E-mail: mtt@heidenhain.de				
Technical training courses outside of Germany	www.heidenhain.com EN ► Service & Support ► Technical training				

Subject index

A

Absolute encoders.....	56
Accessories.....	5
Additional modules.....	27
Advanced Dynamic Prediction (ADP)....	59
API DATA.....	64
Axes.....	52
Axis clamping.....	57
Axis feedback control.....	57

B

Backlash.....	62
Basic modules.....	24
B Axis.....	53
BF 360.....	23, 83
BF 860.....	21, 82
Bus diagnosis.....	64

C

Cable overview.....	39
C-Axis Machining (software option 55)..	54
CMA-H 04-04-00.....	27
Combined PROFIBUS DP/PROFINET IO module.....	27
Compensation of torque ripples.....	57
Component Monitoring.....	61
Components.....	4
ConfigDesign.....	63
Connected Machining.....	73
Connecting cables.....	30
Context-sensitive help.....	61
Control loop cycle times.....	57
Control systems with external safety...	50
Control systems with integrated functional safety (FS).....	48
Counter Spindle (software option 132)..	54
Crossover Position Filter (CPF).....	58

D

Data interfaces.....	71
Degrees of protection.....	75
Digital control design.....	46
Digital servo control.....	57
Display.....	21
Display step.....	6
DNC applications.....	73
Double speed control loops.....	58
Driven tools.....	55

E

EA module for axis release.....	25
Electromagnetic compatibility.....	75
Electronic handwheels.....	28
Encoder inputs.....	56
EnDat 2.2.....	46
Error compensation.....	62
Ethernet.....	71
Expansion PL.....	25
Export version.....	16

F

Feedforward control.....	57
Fieldbus systems.....	27
Functions for the user.....	10

G

Gantry axes.....	53
Gear ranges.....	54

H

HEROS 5.....	51
HR 130.....	30, 91
HR 510.....	28
HR 510, HR 510 FS.....	88
HR 510 FS.....	28
HR 520.....	29
HR 520, HR 520 FS.....	88
HR 520 FS.....	29
HR 550 FS.....	29, 89
HRA 551 FS.....	29, 90
HSCI.....	46
HSCI adapter.....	26
HSCI control components.....	16
Hysteresis.....	62

I

I/O modules.....	25
Incremental encoders.....	56
Industrial PCs/ITC.....	31
Initial setup and diagnostic aids.....	63
Input resolution.....	6
Installation elevation.....	75
Integrated inverter.....	57
Integrated PLC.....	66
Interfacing to the machine.....	8
Inverter system.....	42
IOconfig.....	25
IPC 306.....	32, 76
IPC 6490.....	78
IPC 6641.....	77
IPC 6641.....	32
ITC 860.....	82

J

Jerk.....	59
Jerk limiting.....	59

L

Linear error.....	62
Load Adaptive Control (LAC).....	62
Load Monitoring.....	61
Log.....	64
Look-ahead.....	59

M

Main computer.....	16
Master keyword.....	18
Maximum spindle speed.....	54
MC 306.....	17, 76

MC 366.....	17, 81
MC 8420 T.....	17
MC 8532.....	17, 79
Module for analog axes.....	27
Monitoring functions.....	60
Mounting and electrical installation.....	75
Multi-Channel Capability.....	53

N

Nonlinear error.....	62
----------------------	----

O

Online Monitor.....	64
Operating system.....	51
Oscilloscope.....	63

P

PAE-H 08-00-01.....	25
PL 6000.....	24, 87
PLA-H 08-04-04.....	25
PLB 6001, PLB 600x FS.....	86
PLB 600x.....	26
PLB 6104.....	25
PLB 6104 FS.....	25
PLB 6106.....	25
PLB 6106 FS.....	25
PLB 6108.....	25
PLB 6108 FS.....	25
PLB 6204 EnDat.....	24
PLB 6204 FS EnDat.....	24
PLB 6206 EnDat.....	24
PLB 6206 FS EnDat.....	24
PLB 6208 EnDat.....	24
PLB 6208 FS EnDat.....	24
PLB 6210 EnDat.....	24
PLB 6210 FS EnDat.....	24
PLC axes.....	53, 67
PLC basic program.....	69
PLCdesign.....	67
PLC encryption.....	66
PLC inputs/outputs.....	66
PLC positioning.....	67
PLC programming.....	66
PLC soft keys.....	67
PLC window.....	67
PLD-H 04-04-00 FS.....	25
PLD-H 04-08-00 FS.....	25
PLD-H 08-04-00 FS.....	25
PLD-H 08-16-00.....	25
PLD-H 16-08-00.....	25
PNC 610.....	33
Position-controlled spindle.....	54
PROFIBUS DP module.....	27
PROFINET IO module.....	27
Proper minimum clearance.....	74
Python OEM Process.....	68

R

Real-time coupling function.....	53
Remote Desktop Manager.....	73
RemoTools SDK.....	73

Reversal spikes.....	62
----------------------	----

S

Servo lag.....	57
SIK component.....	18
Sliding friction.....	62
Smoothed jerk.....	59
Snap-on keys.....	35, 37
Software options.....	14
Software tools.....	5
Specifications.....	6
Spindle and counter spindle.....	54
Spindle override.....	54
Spindle Synchronism.....	55
State Reporting.....	64
Static friction.....	62
Storage medium.....	18
Synchronized axes.....	53
System PL with EnDat support.....	24

T

Table function.....	64
TE 725 T.....	22, 85
TE 725 T FS.....	22
TE 745T.....	21, 84
TeleService.....	64
Thermal expansion.....	62
TNCAnalyzer.....	65
TNCdiag.....	63
TNCkeygen.....	18
TNCopt.....	64
TNCremo.....	72
TNCremoPlus.....	72
TNCscope.....	64
TNCtest.....	65
Tool carriers.....	52
Torque Control.....	53
Trace function.....	64
Traverse range.....	52

U

USB.....	71
User administration.....	51
User management.....	13

HEIDENHAIN

DR. JOHANNES HEIDENHAIN GmbH

Dr.-Johannes-Heidenhain-Straße 5

83301 Traunreut, Germany

☎ +49 8669 31-0

FAX +49 8669 5061

E-mail: info@heidenhain.de

www.heidenhain.de

Vollständige und weitere Adressen siehe www.heidenhain.de
For complete and further addresses see www.heidenhain.com

DE	HEIDENHAIN Vertrieb Deutschland 83301 Traunreut, Deutschland ☎ 08669 31-3132 FAX 08669 32-3132 E-Mail: hd@heidenhain.de	DK	Denmark → SE	NZ	Llama ENGINEERING Ltd 5012 Wellington, New Zealand E-mail: info@llamaengineering.co.nz
	HEIDENHAIN Technisches Büro Nord 12681 Berlin, Deutschland ☎ 030 54705-240	ES	FARRESA ELECTRONICA S.A. 08028 Barcelona, Spain www.farresa.es	PH	MACHINEBANKS' CORPORATION Quezon City, Philippines 1113 E-mail: info@machinebanks.com
	HEIDENHAIN Technisches Büro Mitte 07751 Jena, Deutschland ☎ 03641 4728-250	FI	HEIDENHAIN Scandinavia AB 01740 Vantaa, Finland www.heidenhain.fi	PL	APS 02-384 Warszawa, Poland www.heidenhain.pl
	HEIDENHAIN Technisches Büro West 44379 Dortmund, Deutschland ☎ 0231 618083-0	FR	HEIDENHAIN FRANCE sarl 92310 Sèvres, France www.heidenhain.fr	PT	FARRESA ELECTRÓNICA, LDA. 4470 - 177 Maia, Portugal www.farresa.pt
	HEIDENHAIN Technisches Büro Südwest 70771 Leinfelden-Echterdingen, Deutschland ☎ 0711 993395-0	GB	HEIDENHAIN (G.B.) Limited Burgess Hill RH15 9RD, United Kingdom www.heidenhain.co.uk	RO	HEIDENHAIN Reprezentantă Romania Braşov, 500407, Romania www.heidenhain.ro
	HEIDENHAIN Technisches Büro Südost 83301 Traunreut, Deutschland ☎ 08669 31-1337	GR	MB Milionis Vassilis 17341 Athens, Greece www.heidenhain.gr	RS	Serbia → BG
		HR	Croatia → SL	RU	GERTNER Service 119002 Moscow, Russian Federation www.heidenhain.ru
AR	NAKASE SRL. B1653AOX Villa Ballester, Argentina www.heidenhain.com.ar	HU	HEIDENHAIN Kereskedelmi Képviselet 1239 Budapest, Hungary www.heidenhain.hu	SE	HEIDENHAIN Scandinavia AB 12739 Skärholmen, Sweden www.heidenhain.se
AT	HEIDENHAIN Techn. Büro Österreich 83301 Traunreut, Germany www.heidenhain.de	ID	PT Servitama Era Toolsindo Jakarta 13930, Indonesia E-mail: ptset@group.gts.co.id	SG	HEIDENHAIN PACIFIC PTE LTD Singapore 408593 www.heidenhain.com.sg
AU	FCR MOTION TECHNOLOGY PTY LTD Ravenhall Victoria 3023, Australia E-mail: sales@fcrmotion.com	IL	NEUMO VARGUS MARKETING LTD. Holon, 5885948, Israel E-mail: neumo@neumo-vargus.co.il	SK	KOPRETINA TN s.r.o. 91101 Trenčin, Slovakia www.kopretina.sk
BE	HEIDENHAIN NV 1760 Roosdaal, Belgium www.heidenhain.be	IN	HEIDENHAIN Optics & Electronics India Private Limited Chetpet, Chennai 600 031, India www.heidenhain.in	SL	NAVO d.o.o. 2000 Maribor, Slovenia www.heidenhain.si
BG	ESD Bulgaria Ltd. Sofia 1172, Bulgaria www.esd.bg	IT	HEIDENHAIN ITALIANA S.r.l. 20128 Milano, Italy www.heidenhain.it	TH	HEIDENHAIN (THAILAND) LTD Bangkok 10250, Thailand www.heidenhain.co.th
BR	HEIDENHAIN Brasil Ltda. 04763-070 – São Paulo – SP, Brazil www.heidenhain.com.br	JP	HEIDENHAIN K.K. Tokyo 102-0083, Japan www.heidenhain.co.jp	TR	T&M Mühendislik San. ve Tic. LTD. ŞTİ. 34775 Y. Dudullu – Ümraniye-Istanbul, Turkey www.heidenhain.com.tr
BY	GERTNER Service 220026 Minsk, Belarus www.heidenhain.by	KR	HEIDENHAIN Korea Ltd. Anyang-si, Gyeonggi-do, 14087 South Korea www.heidenhain.co.kr	TW	HEIDENHAIN CO., LTD. Taichung 40768, Taiwan www.heidenhain.com.tw
CA	HEIDENHAIN CORPORATION Mississauga, Ontario L5T2N2, Canada www.heidenhain.com	MX	HEIDENHAIN CORPORATION MEXICO 20290 Aguascalientes, AGS., Mexico E-mail: info@heidenhain.com	UA	GERTNER Service 02094 Kiev, Ukraine www.heidenhain.ua
CH	HEIDENHAIN (SCHWEIZ) AG 8603 Schwerzenbach, Switzerland www.heidenhain.ch	MY	ISOSERVE SDN. BHD. 43200 Balakong, Selangor E-mail: sales@isoserve.com.my	US	HEIDENHAIN CORPORATION Schaumburg, IL 60173-5337, USA www.heidenhain.us
CN	DR. JOHANNES HEIDENHAIN (CHINA) Co., Ltd. Beijing 101312, China www.heidenhain.com.cn	NL	HEIDENHAIN NEDERLAND B.V. 6716 BM Ede, Netherlands www.heidenhain.nl	VN	AMS Co. Ltd HCM City, Vietnam E-mail: davidgoh@amsvn.com
CZ	HEIDENHAIN s.r.o. 102 00 Praha 10, Czech Republic www.heidenhain.cz	NO	HEIDENHAIN Scandinavia AB 7300 Orkanger, Norway www.heidenhain.no	ZA	MAFEMA SALES SERVICES C.C. Kyalami 1684, South Africa www.heidenhain.co.za