



# HEIDENHAIN



## CNC PILOT 640

The Control for Lathes and  
Turning-Milling Machines



09/2021



CNC PILOT 640  
With a  
15.6-inch touchscreen

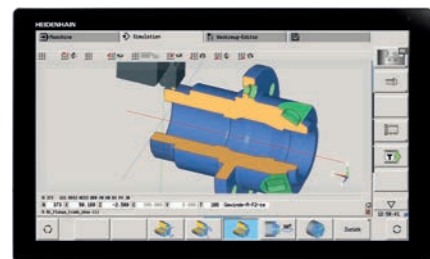

CNC PILOT 640  
With a  
24-inch touchscreen

Windows 7, Windows 8, and Windows 10 are trademarks of Microsoft Corporation

**Options** are functions integrated into the control, allowing the functionality of the CNC PILOT 640 to be adapted to the customer's needs at a later time. Some options, however, must be adapted by the machine manufacturer.

The specifications described here apply to the following control and NC software versions:

**CNC PILOT 640 with NC software versions**  
688946-08 (export license required)  
688947-08 (export license not required)

This brochure supersedes all previous editions, which thereby become invalid. **Subject to change without notice.**



## The CNC PILOT 640

Where can it be used?	<b>Versatile and effective</b> CNC PILOT 640: the control for lathes and turning-milling machines	<b>4</b>
What does it look like?	<b>Intuitive and user-friendly</b> Modern multi-touch operation and convenient screen layout	<b>6</b>
What can it do?	<b>Fast, accurate, and reliable machining</b> Fully digital control design Smart machining	<b>8</b>
	<b>Effective, well-structured, and flexible</b> Make programming easy with smart.Turn (option) High-performance NC programs with DIN PLUS An NC program at the stroke of a key with TURN PLUS (option)	<b>10</b>
	<b>Describe and import contours</b> Interactive Contour Programming (ICP)	<b>16</b>
	<b>Realistic control prior to machining</b> The graphical simulation	<b>18</b>
	<b>Expandable for all cases</b> Turning, drilling, and milling in a single setup (option) Single-setup machining, including C and Y axis (option) Machining with the B axis and simultaneous machining	<b>20</b>
	<b>High-performance Teach-in mode (option)</b> Cycles, the pre-programmed working steps	<b>26</b>
	<b>Tool data and cutting data are readily available</b> The tool and technology database of the CNC PILOT 640	<b>30</b>
	<b>Open for external information</b> Fully digital job management with Connected Machining The DataPilot CP 640 programming station Rapid availability of all information	<b>32</b>
What accessories are there?	<b>Measuring workpieces</b> Machine setup, setting presets, and measuring with touch trigger probes	<b>36</b>
	<b>Tool measurement</b> Determine the length, radius, and level of wear directly in the machine	<b>37</b>
... At a glance	<b>Overview</b> User functions Options Accessories Specifications	<b>38</b>

## Versatile and effective

### CNC PILOT 640: the control for lathes and turning-milling machines

Thanks to its versatile design and programming capabilities, the CNC PILOT 640 provides you with the support you need, regardless of whether you make simple or complex parts in single runs or batches. Operating and programming the CNC PILOT 640 is very convenient and requires very little training.

The CNC PILOT 640 is designed for CNC lathes and can be used on horizontal and vertical boring and turning mills.

The CNC PILOT 640 supports lathes with a main and counter spindle, a C axis, or positionable spindle, B and Y axes, and driven tools.

In multi-channel machining, different machining steps can be performed simultaneously using multiple slides.

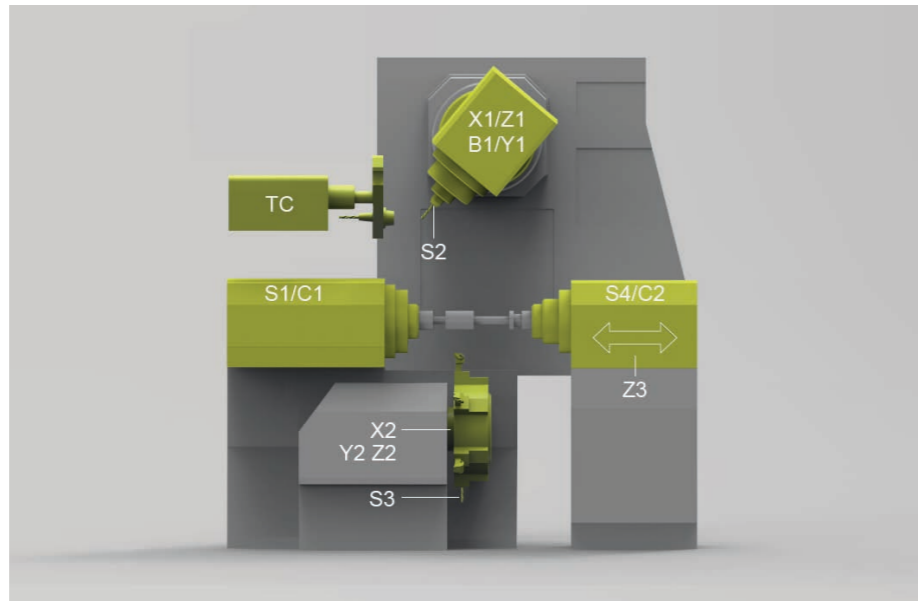

Regardless of whether you are turning simple parts or complex workpieces, the CNC PILOT 640 gives you the benefits of graphical contour input and convenient programming with smart.Turn.

If you need to program with variables, control special machine components, or use externally created programs, etc., you can simply switch to DIN PLUS, where you'll find the right solution for your specific task.

#### Compatibility

The CNC PILOT 640 can also run already existing NC programs from older HEIDENHAIN lathes. A convenient import filter makes it easy for you to transfer older programs (e.g., from the CNC PILOT 4290) to the new control for continued use.

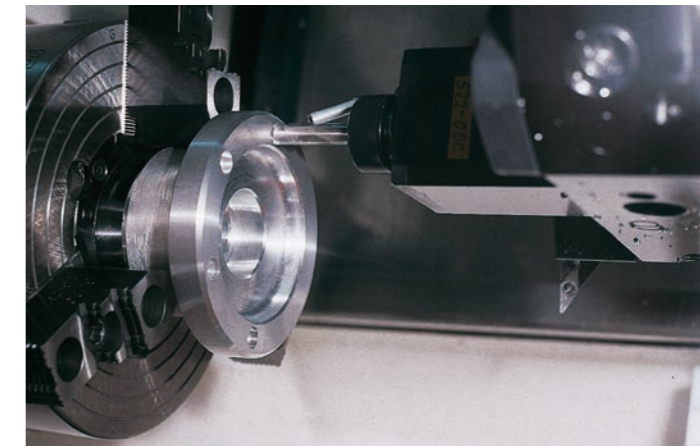

From simple jobs on a compact machine ...

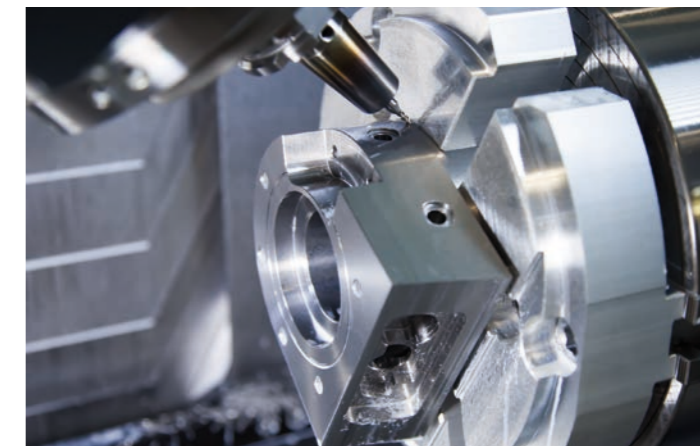

... to complex tasks,



... to serial production

# Intuitive and user-friendly

## Modern multi-touch operation and convenient screen layout

### The screen

The CNC PILOT 640 is equipped with a practical splash-proof, scratch-resistant, IP54-rated touchscreen designed for harsh shop conditions. The screen can be operated by means of gestures already familiar from mobile devices.

The CNC PILOT 640 is available in different screen formats. The 19-inch version lends itself to large or multi-channel machines requiring a larger field of view. The smaller 15.6-inch widescreen is ideal for compact machines. In Programming mode, the widescreen version ensures a comfortable overview of your programs.

The CNC PILOT 640 gives you an excellent overview of the information you need during programming, program verification, and machine operation.

While you're programming, helpful images explain the required parameters. And during program simulation, tool movements are shown in realistic detail. While the program is running on the machine, the CNC PILOT 640 displays information about the tool position, speed, motor loading, and the machine status.

### The keyboard

The CNC PILOT 640 doesn't need an excessive number of keys. All of the functions are clearly identifiable thanks to easily understood symbols.

The keys on the numeric keypad are used for entering data and selecting functions. The menu window shows the available functions via images. Soft keys let you make changes to selected functions, apply position values and technology data, and control data input.

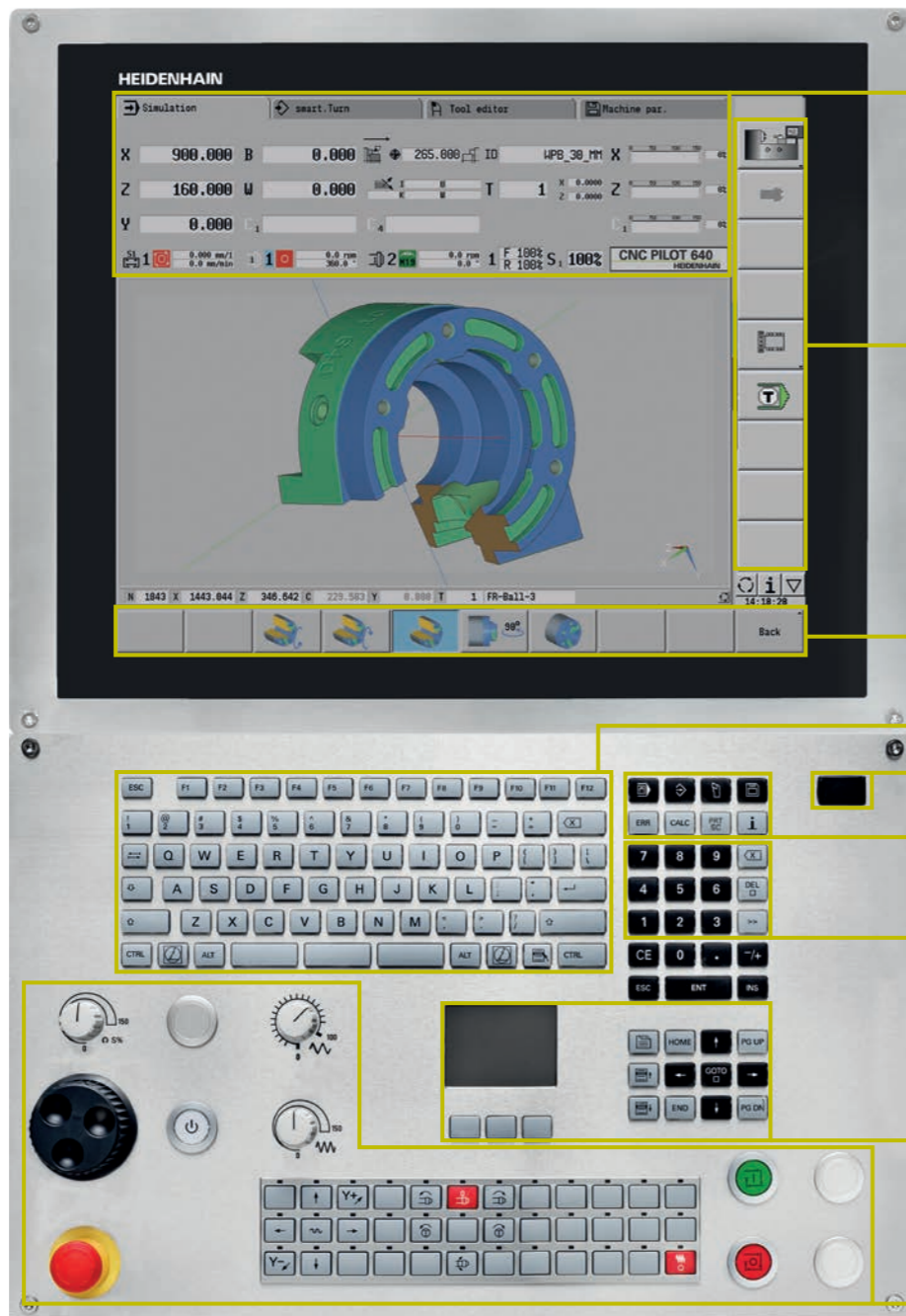

Display of operating modes and the machine status (configurable). You can fill this area with up to 25 different display segments. Different display segments are stored for Manual mode and Automatic mode.

PLC soft keys for machine functions

Self-explanatory soft keys for the respective operating mode

Alphanumeric keyboard for comments

USB port

Keys for operating modes and functions

Keypad for numerical input and fast menu selection

Navigation keys

Machine operating panel with override potentiometers

### Ergonomic and sturdy design

The optimized stainless steel operating panel of the CNC PILOT 640 features a special protective cover, making it highly resistant to contamination and wear. The labeling on the ergonomically shaped keys can withstand extreme shop conditions. You can also adjust the feed rate, rapid traverse, and spindle speed settings with handy control knobs.

### Intuitive touchscreen operation

The operator-friendliness of the CNC PILOT 640 has proven itself over many years. Users throughout the world use dialog keys, navigation keys, and soft keys to operate their CNC PILOT 640. For even more innovative and user-friendly operation, the CNC PILOT 640 now also comes in a touchscreen version. This version combines the proven benefits of HEIDENHAIN controls with state-of-the-art operation through tapping, swiping, and dragging gestures.

### Practical touchscreen

The touchscreen is ideal for a shopfloor environment because it can still be operated when exposed to coolant, oil, and other factors. To lock the screen for cleaning, simply select the "Touchscreen Cleaning" mode. The touchscreen can also be operated with different types of work gloves.

### Gestures for multi-touch operation

The screen of the CNC PILOT 640 can be operated with gestures already familiar to you from your smartphone or tablet. For example, you can zoom in or out with two fingers, or swipe to rapidly navigate through programs, menus, and the soft-key row.

Symbol	Gesture
	Tap
	Double tap
	Long press
	Swipe
	Drag
	Two-finger drag
	Spread
	Pinch

# Fast, accurate, and reliable machining

## Fully digital control design

Thanks to its digital design, the CNC PILOT 640 can control the entire motion system. This proven digital technology from HEIDENHAIN enables high contour fidelity and fast machining at high accuracy. What's more, all control components of the CNC PILOT 640 are connected via a digital interface.

### Digital drive technology

A position controller, speed controller, and current controller (if needed) are integrated into the CNC PILOT 640. Its digital motor control enables very high feed rates.

### High contour fidelity

The CNC PILOT 640 dynamically calculates the contour in advance, allowing the lathe control to rapidly adapt the axis speed at contour transitions. Special algorithms control the axes, ensuring motion control within the speed and acceleration limits.

### High availability

The fully digital design of the CNC PILOT 640 connects all of the components via purely digital interfaces. Control components are connected via the HEIDENHAIN Serial Controller

Interface (HSCI), a real-time protocol for fast Ethernet. Encoders are connected via EnDat 2.2, the bidirectional interface from HEIDENHAIN.

This results in high overall system availability, from the main computer to the encoder. It is also diagnosable and immune to interference.

The fully digital solution from HEIDENHAIN ensures exceptionally high accuracy and surface quality at high traversing speeds.

# Smart machining

### Load monitoring: detect tool wear and breakage during machining\*

Load Monitoring tracks the machine's spindle and motor loading, comparing it with load values from a reference operation. The CNC PILOT 640 can graphically visualize the load values in a separate window.

You can set two limit values that trigger different error reactions. If the first limit value is exceeded, the current tool is flagged as worn, and the control automatically exchanges it with a previously defined replacement tool during the next tool call. After the second limit value has been exceeded, the CNC PILOT 640 assumes that there is an impermissible load (e.g., tool breakage) and stops the machining operation. This improves process reliability during machining, particularly during unattended shifts.

\* The machine and control must be adapted by the machine manufacturer for this function.

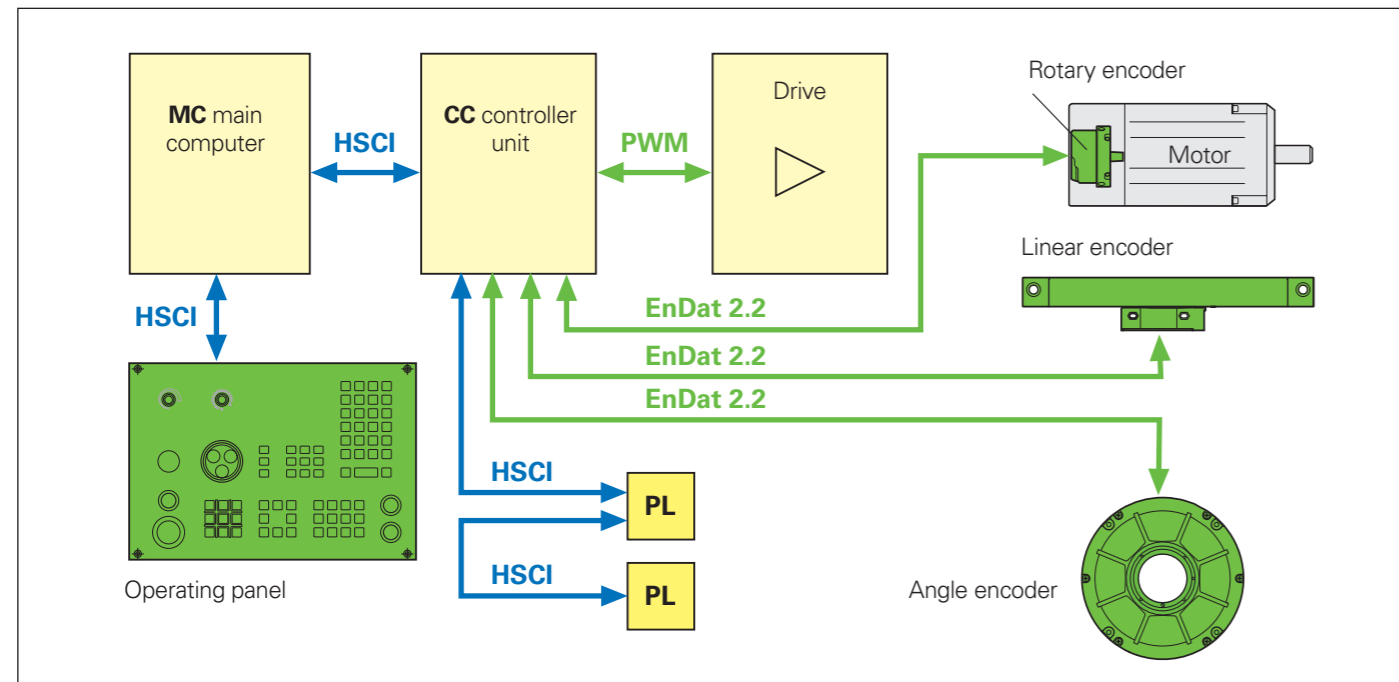

### Batch mode

The batch mode function lets you run multiple main programs automatically. You can also define the part programs and their number of parts in a program list. The CNC PILOT 640 can then automatically execute this list without programs being manually selected and started. Batch mode is ideal for scenarios in which different operations are performed on a consistent raw material supplied by bar loaders or robots.

### Program-run graphics

The program-run graphics display the machining operation in real time, revealing the current state of the workpiece. Direct observation during machining is often impossible. In addition, you can switch between different operating modes at any time, letting you simultaneously work on a program, for example. Then, while programming, you can simply press a button to check the machining progress.

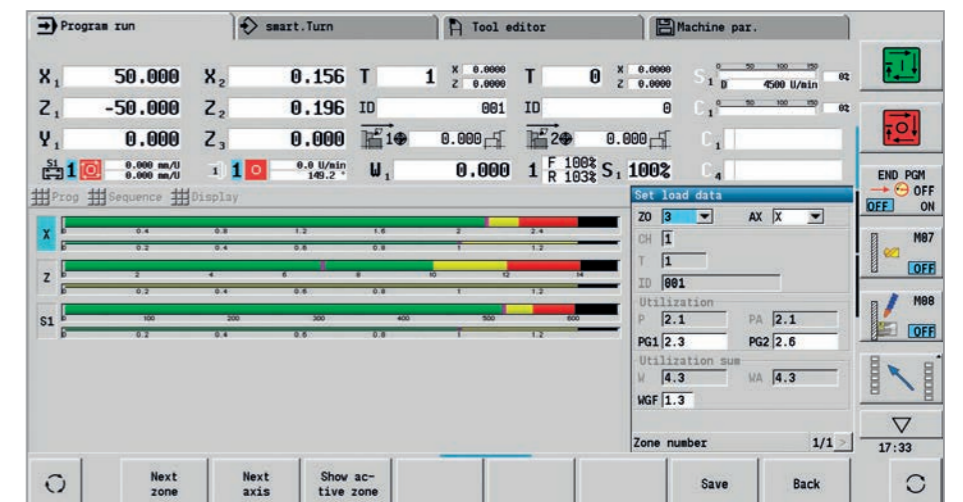

Graphical depiction of the load values with Load Monitoring

# Effective, well-structured, and flexible

## Make programming easy with smart.Turn (option)

Has the safety clearance been correctly entered, has the speed limitation been taken into account, and what oversizes have been defined? All of these questions need to be considered by novice and expert NC programmers alike during conventional DIN programming.

### The smart.Turn principle

The working block, called a unit, plays a key role in smart.Turn programs. A unit completely and unambiguously defines a single working step. The unit includes the tool call, the technology data, the cycle call, and the approach and departure strategies, along with global data such as the safety clearance. All of these parameters are displayed in an intuitive dialog box.

The smart.Turn principle gives you the reassurance that the working block is fully and correctly defined. The unit's DIN PLUS commands are listed in the NC program by smart.Turn. This gives you an overview of all working-block details at any time.

### The unit

All of the parameters of a smart.Turn unit are contained in intuitive fillable forms. The overview form gives you the big picture about the selected unit, while subforms provide information on the details of the working block. Intuitive help images illustrate all of the required inputs. If input options are available, smart.Turn displays a list of the available options for selection.

And you do not need to stop the manufacturing process to program with smart.Turn, since you can create and test the smart.Turn program while the program is running.

Intuitive dialogs, with help images explaining the parameters

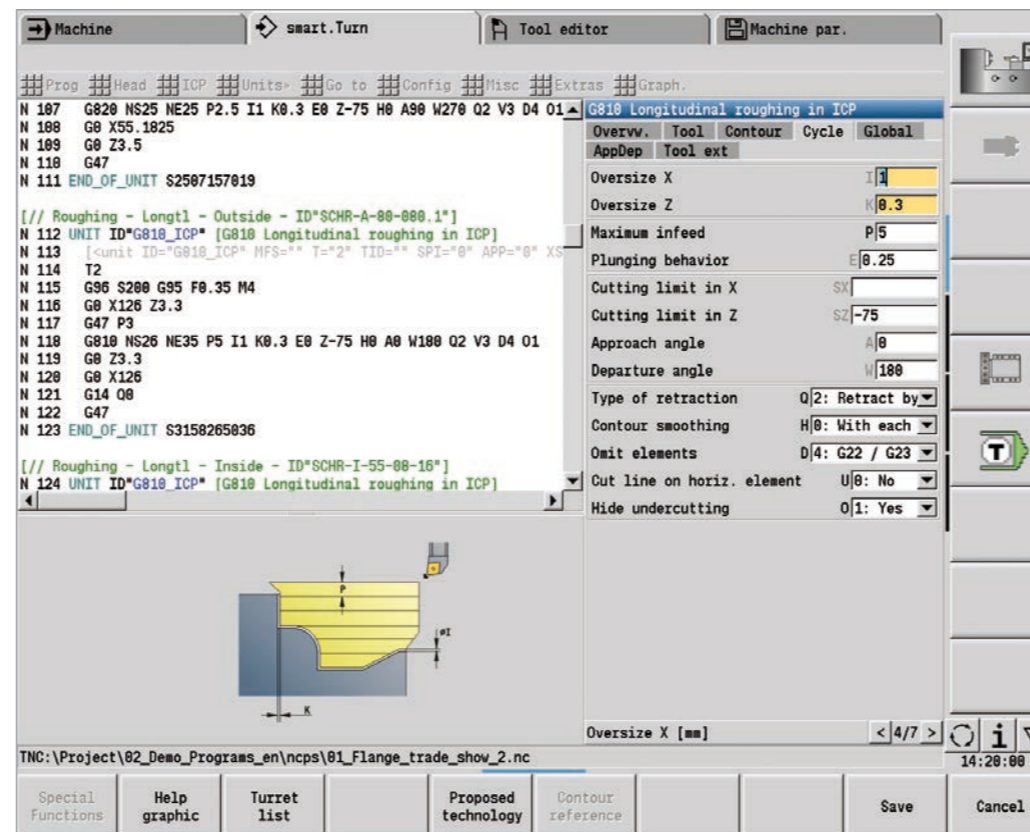

### Intuitive and clearly formatted

Programs created with smart.Turn are known for their intuitive structure and easy understandability. The smart.Turn tool uses section codes that clearly distinguish between the program head (containing setup information), tools assigned in the turret, the workpiece description, and the actual machining operation.

You will be guided by the dialog to enter data in this sequence:

- Program head
- Tools assigned in the turret
- Description of workpiece blank
- Description of finished part
- Individual machining steps

The smart.Turn approach ensures that the program is easy to read and allows you to save all information in the NC program for making the part.

### Production data at a glance

The program head includes all important information about the workpiece (e.g., drawing number, date, programmer, material, fixture, etc.).

All of the information that is important for setting up and machining the workpiece, such as the tool assignment in the turret, is included in the NC program.

### Programming in more than one window

Up to six NC programs can be opened simultaneously in the DIN PLUS editor. The NC program to be displayed is selected via the smart keys. This allows you to transfer program blocks from one NC program to another or quickly gain an overview of complex NC programs, including subprograms.

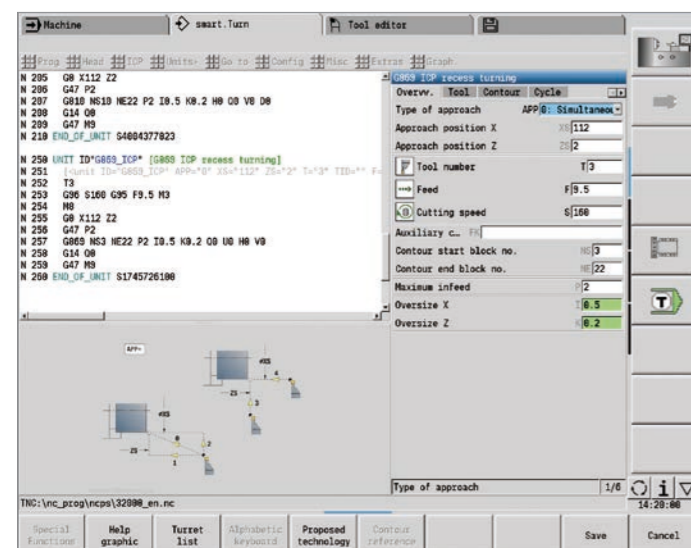

Input form in smart.Turn

```

N 250 UNIT ID"G869_ICP" [G869 ICP recess turning]
N 251 [<unit ID="G869_ICP" APP="0" XS="112" ZS="2"
N 252 T3
N 253 G96 S160 G95 F9.5 M3
N 254 M8
N 255 G0 X112 Z2
N 256 G47 P2
N 257 G869 NS3 NE22 P2 I0.5 K0.2 Q0 U0 H0 V0
N 258 G14 Q0
N 259 G47 M9
N 260 END_OF_UNIT S1745726100
    
```

smart.Turn unit in the NC program

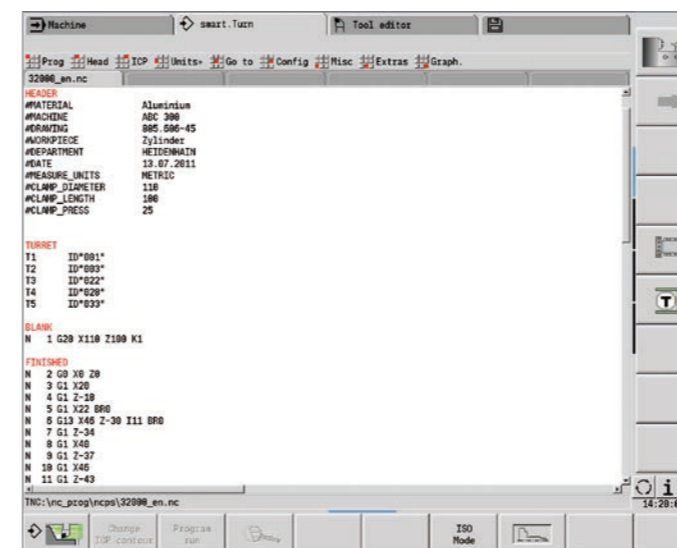

smart.Turn program with section codes

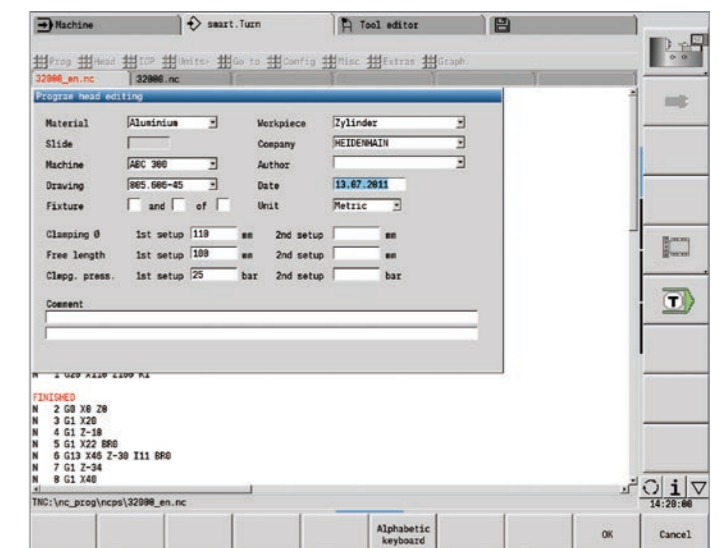

Entry form for the program head

# Effective, well-structured, and flexible

Make programming easy with smart.Turn (option)

## Programming made simple

Global parameters, such as oversizes, safety clearances, coolant on/off, etc., are defined once in the start unit and then transferred by smart.Turn to the other units.

Within the NC program, smart.Turn lists the DIN PLUS instructions of this unit. This gives you an overview of all working block details and provides you with an intuitive, well-structured NC program.

The smart.Turn tool supports units for roughing, finishing, recessing, recess turning, thread cutting, drilling, tapping, and milling, as well as special units for program start, program end, moving the C axis in/out, subprograms, and program-section repeats.

## Programming contours

The smart.Turn tool makes your work easier and more flexible. Simple contours can be defined with just a few entries in the cycle. Complex contours can be defined with graphical interactive programming (ICP) or through an uploaded DXF part description. Contours remain readable and editable when stored in the NC program, allowing you to make changes in either smart.Turn or the ICP editor.

## Contour follow-up

Another highlight of the CNC PILOT 640 is its contour follow-up functionality. If you define the workpiece blank at the beginning of your smart.Turn or DIN PLUS program, then the control will calculate the current state of the blank after every cut. The machining cycles always take this current state into account. Contour follow-up lets you avoid air cuts and optimize approach paths through the space created by material removal.

## Suggested technology data

The CNC PILOT 640 stores your cutting data based on the workpiece material, tool material, and type of machining operation. Since the tool material is already specified when you describe the tool, you only need to enter the workpiece material. This provides smart.Turn with all of the data it needs in order to suggest cutting values.

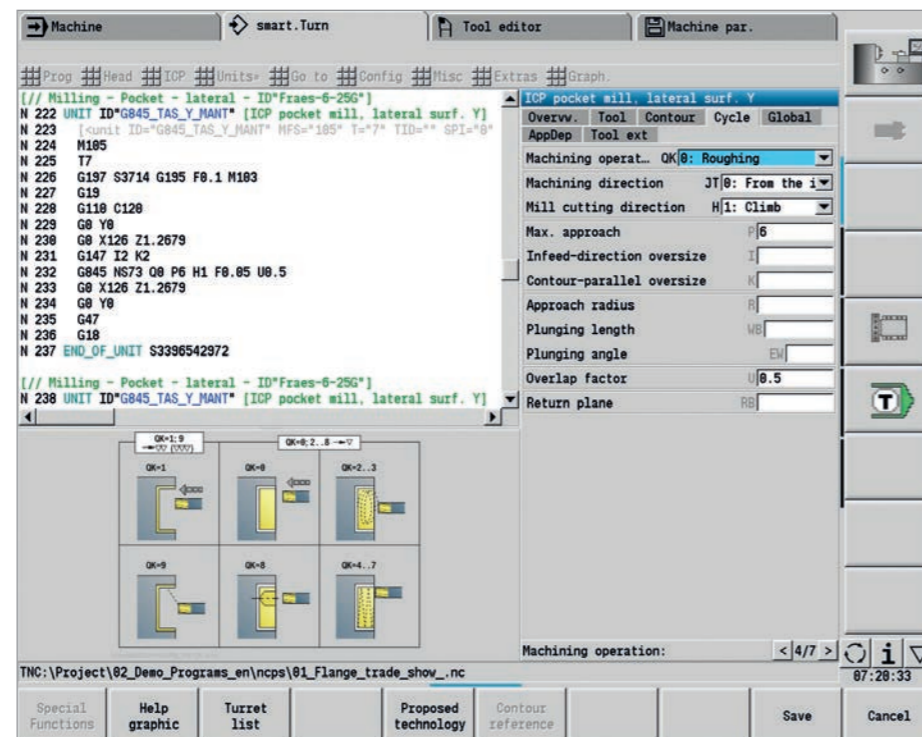

smart.Turn dialogs with help images

# High-performance NC programs with DIN PLUS

## Programming in DIN PLUS

Units are available in smart.Turn for all machining tasks, including for special functions. But if you need to program with variables, control special machine modules, or use complex functions not included in smart.Turn, then you can use DIN PLUS, which puts high-performance machining cycles, program branching, and programming with variables at your disposal. You can even switch between smart.Turn and DIN PLUS programming within a single program.

Because the units are based on DIN PLUS, you can "dissolve" a unit anytime into a DIN PLUS program section as a basis for fine-tuning and optimization.

The CNC PILOT 640 also lets you create DIN programs or upload and use externally created programs.

## High-performance cycles in DIN PLUS

The DIN PLUS cycles let you define the contour section to be machined by simply marking the appropriate area in the verification graphics. You can then immediately test each working step in the simulation.

The relevant commands can be selected from a menu or entered directly in G-code. A dialog box appears in which you enter the parameters. All of these entries are explained with visual aids and plain language texts.

Thanks to these highly effective machining cycles and their assignment to machining sections, DIN PLUS delivers greater effectiveness and flexibility than conventional NC programming.

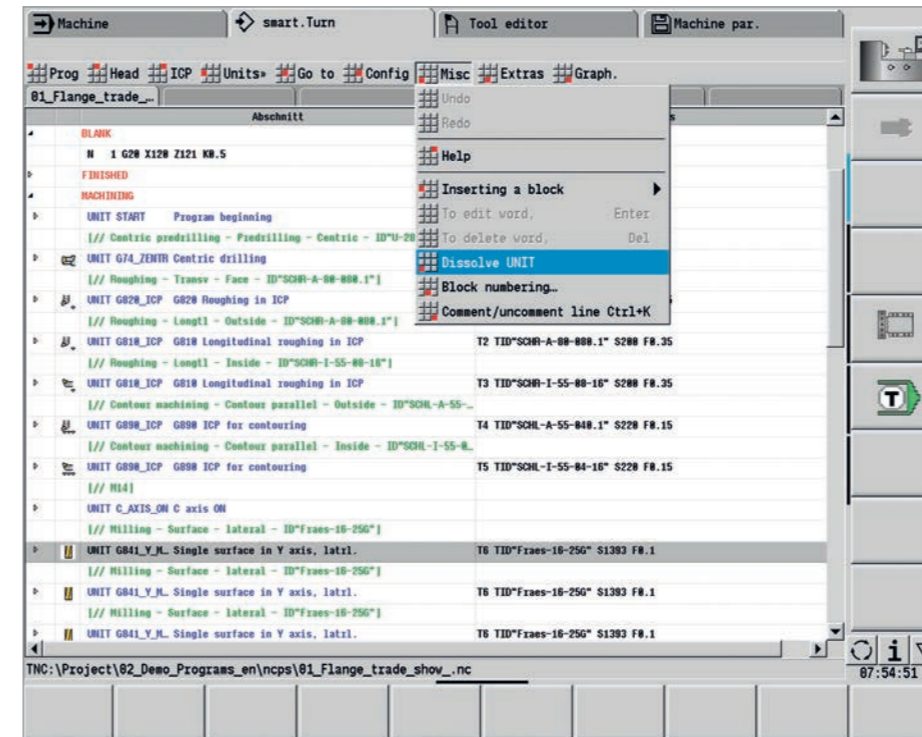

smart.Turn program in tree view with a dissolved smart.Turn unit

## Effective, well structured, and flexible

### An NC program at the press of a button with TURN PLUS (option)

TURN PLUS lets you create NC programs in very little time: after you've described the workpiece blank and final contour, all you need to do is select the workpiece material and workholding equipment. TURN PLUS does everything else automatically: it generates the working plan, selects the machining strategy, selects the tools and cutting data, and generates the NC blocks.

The result is a thoroughly commented smart Turn program with working blocks (units), giving you assurance and room for optimization when first running the NC program.

TURN PLUS can do all of this for milling and drilling operations with the C or Y axis on front face and lateral surfaces, as well as on rear-face surfaces on machines with counter spindles.



#### An NC program at a keystroke

When short programming times are important, you can generate all of the working steps with only a single keystroke. Using the entered contour and the information from the technology database, TURN PLUS automatically creates the working plan and selects suitable work strategies, tools, and cutting data. This takes only a few seconds, and you can monitor each individual working step in the verification graphics. TURN PLUS has now provided a logical sequence of machining possibilities, such as "first transverse roughing, then longitudinal roughing," or "finishing outside, then finishing inside." However, you can also adapt this sequence on your own to suit various tasks. In this manner, the CNC PILOT 640 also has the machining expertise of your company at its disposal, even during automatic working plan generation.

#### Automatic program generation for the complete contour

The CNC PILOT 640 control can automatically create NC programs for complex workpieces with machining operations on the front face, rear side, and lateral surface as well. After you have defined the geometry, this can save you about 90 % of the time otherwise needed to create a program.

#### Automatic program generation for the second setup

TURN PLUS knows the contours of the clamping devices and takes them into account when automatically generating the working plan. The cutting path is thereby automatically kept at a safe distance from the workholding equipment. Once the program for the first setup is complete, you can "rechuck" using interactive graphics. The control then automatically generates the program for the second setup without you needing to re-enter the workpiece geometry.

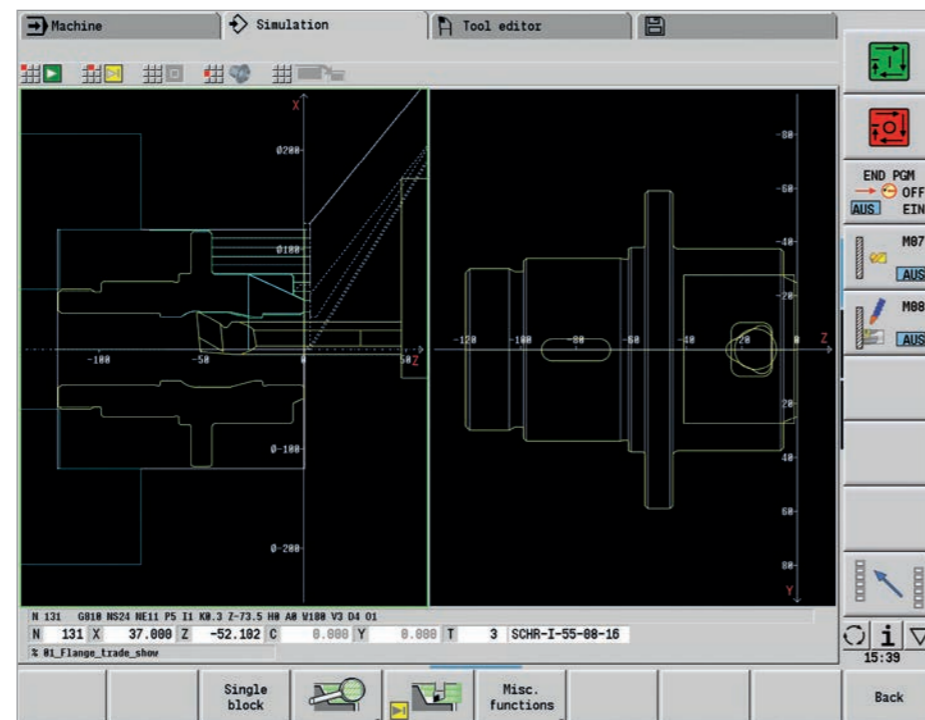

#### Inclined contours are no problem

When it comes to automatically generating the NC program for inclined contours, the control is confronted with unique demands. The angle at which the contour falls is often steeper than the angle of the tool tip. In this case, the control automatically selects a different tool and performs the machining operation in the opposite direction or as a recess. In any case, the result is an executable NC program.

#### Defining the machining sequence

A standard machining sequence can be defined in the TURN PLUS dialog. Various machining sequences, such as for chuck parts, shaft machining, etc., can be stored.

From the global main types of machining operations, such as "roughing," "finishing," or "drilling," to details such as defining a tool for a specific operation, the automatic working plan generation (AWG) feature can be adapted to suit the user's requirements.

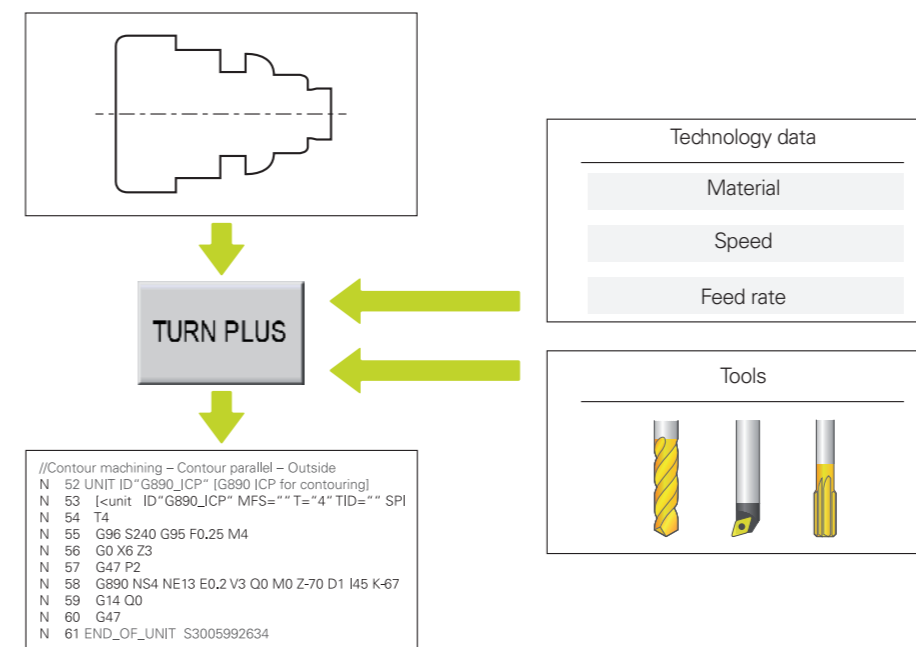

Reliably moving from programming to the first cut in the shortest possible time with TURN PLUS



# Describe and import contours

## Interactive Contour Programming (ICP)

Interactive Contour Programming (ICP) helps in the case of complex parts or incomplete part dimensioning. With it, you describe the contour elements directly as they appear in the workpiece drawing. Or—if the drawing is available in DXF format—you simply import the contour.

### Contour programming with ICP

You define an ICP contour by entering the contour elements one after the other in the graphic editor. When selecting the contour elements, you merely specify the direction of the line or the direction of rotation of the circular arc. The CNC PILOT 640 doesn't need much input to create the contour element.

When entering the data, you decide whether the coordinates are to be absolute or incremental, whether lines are defined by their end point or length, and whether circular arcs are to be specified by their center point or radius. You also specify whether the path to the next contour element should be tangential or non-tangential.

The CNC PILOT 640 calculates missing coordinates, intersections, center points, etc., if they are mathematically defined. If the entered data permit multiple mathematically possible solutions, then you can view the alternative proposals and select the one you prefer. You can also add to or modify existing contours.

### Superimposing form elements

The ICP editor recognizes the chamfer, rounding, and undercut form elements (DIN 76, DIN 509 E, DIN 509 F, etc.). You can enter these form elements during sequential contour definition. However, it is often easier to first define the "rough" contour and then superimpose the form elements. This is done by selecting the corner on which the form element is to be placed and then inserting the element.

### ICP contours for smart.Turn and DIN PLUS

In smart.Turn, you have various possibilities for describing the contour to be machined. You can describe standard contours directly within the unit, or you can use ICP to define complex turning or milling contours as well as linear or circular drilling and milling patterns. The contour defined with ICP is incorporated into the smart.Turn program. Within the unit, you refer to the contour section to be machined. ICP contours are saved in the NC program in a readable and editable form. This gives you the benefit of choosing either smart.Turn or the ICP editor to edit the contours.

If you are working in DIN PLUS mode, you can likewise use ICP to describe the turning and milling contours, as well as the linear and circular patterns. In the contour-related cycles, you enter a reference to the contour section to be machined.

The ICP editor can be called from within smart.Turn.

### DXF import of contours (option)

Why should you painstakingly enter contour elements if the data already exists in the CAD system? ICP gives you the option of importing contours in DXF format directly into the CNC PILOT 640. Not only do you save time that would otherwise be spent on programming and testing but you also ensure that the finished contour exactly corresponds to the design engineer's specification. DXF contours can describe workpiece blanks, finished parts, contour trains, and milling contours. They must be available as two-dimensional elements within a separate layer (i.e., without dimension lines, wrap-around edges, etc.).

First, import the DXF file into the CNC PILOT 640 via the network or the USB flash drive. Since the DXF format is fundamentally different from the ICP format, the contour is converted from DXF to the ICP format during the import. This contour is then treated as a normal ICP contour, and is available for smart.Turn or DIN PLUS programming.

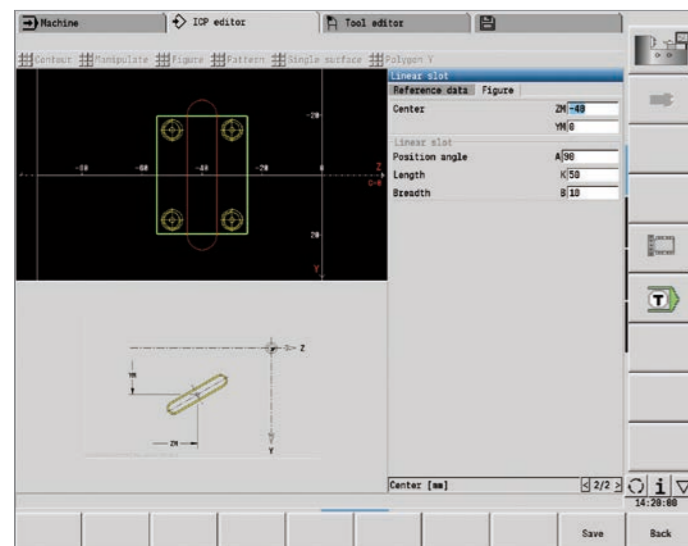

Define the contour element in ICP

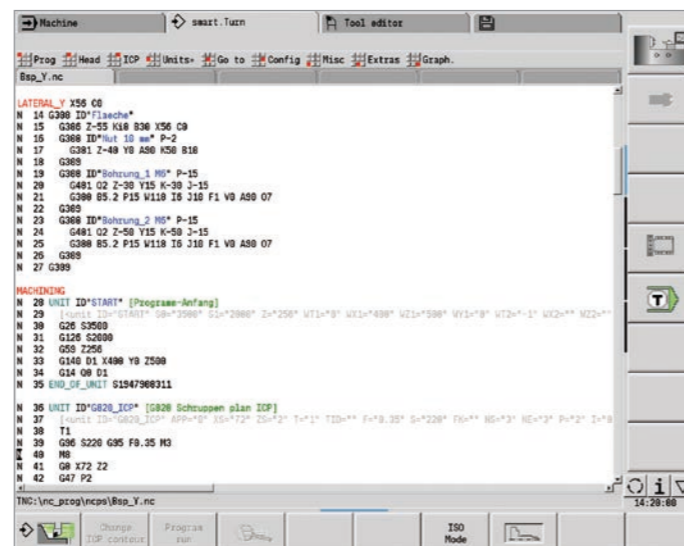

ICP contour description in the NC program

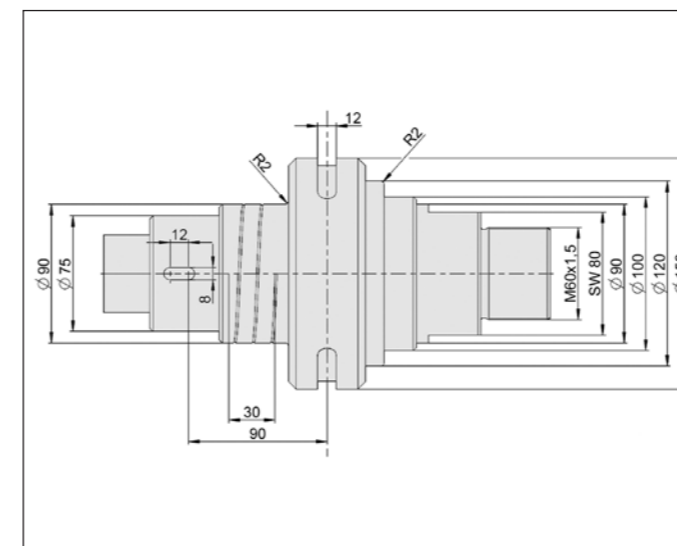

Workpiece drawing

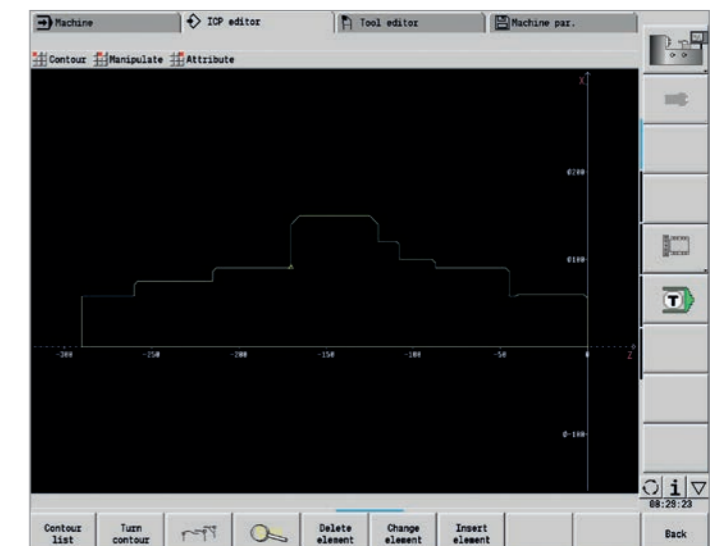

Contour description in the ICP editor



## Expandable for all cases

### Turning, drilling, and milling in a single setup (option)

The CNC PILOT 640 features an extensive package of powerful cycles for standard machining operations and special applications, thus optimally equipping you for everyday shopfloor challenges.

#### Multiple plunging

The multiple plunging cycle lets you machine deep and wide slots very efficiently. The low lateral deflection of the tool enables up to 50 % higher feed rates than those of conventional recessing cycles. In the process, the cycle automatically executes all working steps (recessing, ridge removal, and finishing).

The CNC PILOT 640 can also perform follow-up drilling and milling operations on the front face or lateral surface in a single setup. In addition, the control offers numerous functions and practical cycles.

\* Optional. The machine and the CNC PILOT 640 must be adapted for this function by the machine manufacturer.

#### Drilling, deep-hole drilling, tapping

The CNC PILOT 640 can perform individual drilling, deep-hole drilling, and tapping operations with the C or Y axis. Using parameters, you can easily program infeed reductions when drilling partly or completely through the workpiece.

#### Drilling and milling patterns

If holes, slots, or ICP milling cycles are located at regular distances on a straight line or a circular arc, then the CNC PILOT 640 greatly simplifies your work, letting you create these patterns on the front face or lateral surface with just a few keystrokes.

#### Thread milling

The CNC PILOT 640 supports special thread milling tools, allowing you to leverage the benefits of thread milling on lathes with a C or Y axis.

#### Milling slots and simple figures

Milling slots couldn't be easier with the CNC PILOT 640. After you define the slot's position, depth, and cutting values, the milling cycles takes care of the rest automatically.

Even for simple contours such as circles, rectangles and equilateral polygons, just a few keystrokes are necessary to define the shape and position.

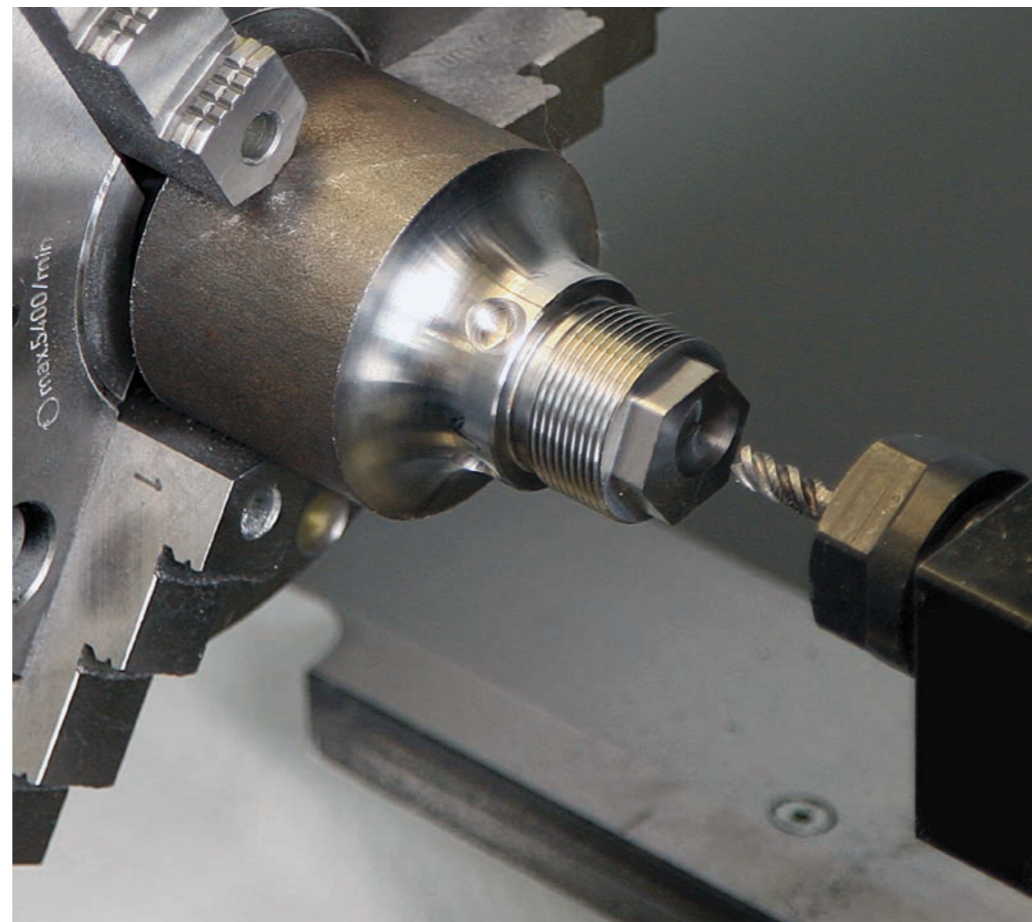

#### Hobbing

Hobbing allows you to conveniently and cost-effectively manufacture high-value gear teeth. The CNC PILOT 640 enables the complete machining of straight and angled gear teeth in a single clamping, calculating and executing all motion sequences from a cycle.

#### Contour and pocket milling

The milling cycles of the CNC PILOT 640 support both contour milling and pocket milling. You define all of the important details, such as the machining direction, milling direction, approach behavior, departure behavior, feed rates, etc. The CNC PILOT 640 then automatically accounts for the cutter radius. You can mill the pocket with a roughing stage and a finishing stage, resulting in high accuracy and excellent surface quality.

The CNC PILOT 640 supports different plunging strategies during smart.Turn and DIN programming. You can choose between direct, reciprocating, or helical infeeds, or an infeed at the pre-drilling position.

#### Face milling

The face milling cycle machines individual surfaces, equilateral polygons, or a circle, even off-center ones.

#### Helical slot milling

The helical slot milling function is ideal for the machining of lubrication grooves. You simply enter all key parameters, such as the pitch, milling multiple infeeds, etc.

#### Engraving cycles

Would you like to inscribe your workpieces? That's no problem with the CNC PILOT 640. With just a few parameters, the smart.Turn engraving units can inscribe characters of any size on a face or lateral surface, or in the XY or YZ plane.

On the front face, the characters can be arranged in a line or an arc. You can define the angle at which the characters are arranged on the lateral surface, and when engraving with the Y axis. The time function lets you engrave the current date and time on your workpiece.

The engraving cycles are also available as DIN PLUS cycles.

#### Deburring

The CNC PILOT 640 supports special units and DIN PLUS cycles for deburring, letting you program this operation with just a few parameters.

#### Trochoidal milling

Trochoidal milling lets you efficiently machine various pocket shapes (circles, rectangles, and polygons) and any desired slot. Roughing is performed with circular movements superimposed onto forward linear motion. Trochoidal milling enables high removal rates and reduces chatter.

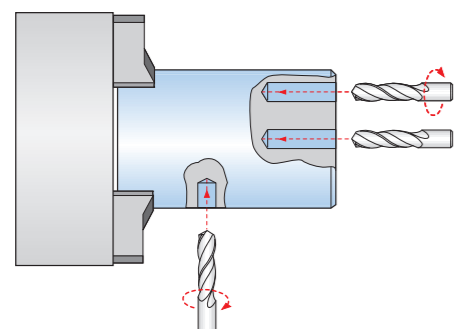

Drilling or tapping

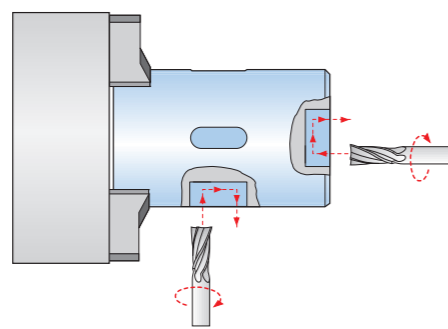

Face and lateral-surface milling



Drilling



Deep-hole drilling



Tapping



Thread milling



Slot milling



Figure milling  
(circles, rectangles,  
equilateral polygons)



ICP contour milling



Face milling (single  
surface, flat  
surface, polygon)



Helical slot milling

smart.Turn units and DIN PLUS cycles for drilling

smart.Turn units and DIN PLUS cycles for milling

## Expandable for all cases

### Single-setup machining, including C and Y axis (option)

The CNC PILOT 640 offers the right solution for any machining task and machine design: it enables complex machining operations with the C axis or Y axis, as well as single-setup machining on machines with a counter spindle.

You can also choose between the programming modes DIN PLUS, smart.Turn, and Teach-in for C-axis, Y-axis, and single-setup machining.

#### C axis or positionable spindle\*

For more demanding tasks, the CNC PILOT 640 supports a C axis or positionable spindle and a driven tool. The driven tool makes it possible to drill off-center and to tap holes while the main spindle is at rest. The C axis or positionable spindle permits milling and drilling operations on the front face and lateral surface of the workpiece. For programming and inspecting these machining sections, the workpiece is shown in the front face view and in the unrolled lateral surface view.

#### Y axis\*

The CNC PILOT 640 lets you create slots or pockets with even surfaces and vertical slot angles using the Y axis. You can define the position of the milling contours on the workpiece by defining the spindle angle. For programming and verifying these machining sections, the workpiece is shown in the side and front face views. The Y axis is supported in the smart.Turn and DIN programming modes.

#### Counter-spindle expansion

For full-surface lathes, the CNC PILOT 640 provides the following control features:

- Counter spindle with second C axis
- Movable tailstock (W axis)

Further assistance is provided by additional functions, such as coordinate transformation, spindle synchronization, and traversing to a fixed stop.

\* The machine and control must be adapted by the machine manufacturer for this function.

#### Coordinate transformation

The contours of workpiece blanks and finished parts can be mirrored about the X axis or shifted relative to the workpiece datum.

#### Spindle synchronization

The two spindles are electronically coupled and rotate synchronously. This makes it possible to transfer the workpiece from one spindle to the other in mid-rotation, thereby saving time otherwise spent braking and starting the spindles. The CNC PILOT 640 records any angular offset, taking it into account during later milling operations on the counter spindle.

#### Traversing to a fixed stop

To ensure that the workpiece is firmly pressed onto the opposing spindle surface, the control monitors the nominal and actual positions during traversing of the counter spindle, thereby detecting the fixed stop.

The CNC PILOT 640 monitors the motor torque and uses it to reach the programmed contact force.

#### Eccentric turning and non-circular turning\*

The CNC PILOT 640 provides convenient cycles for eccentric turning operations and for making non-circular turned parts. In this case, alongside actual contour machining, additional traversing movements of the X and Y axes are synchronously superimposed onto the rotational movement of the spindle. Eccentric and non-circular parts can therefore be machined without additional mechanical elements.

\* The machine and control must be adapted by the machine manufacturer for this function.

#### External gear hobbing

Cycle G808 HOBGING allows you to machine external cylindrical gears or helical gears of any angle. During hobbing, the rotations of the tool and the spindle are synchronized while the cutter moves along the workpiece axially.

Cycle G808 automatically controls these complex movements and allows you to conveniently enter all of the relevant values. You can use gear parameters directly from your drawing, and the cycle will use them to calculate the sequence of motion.

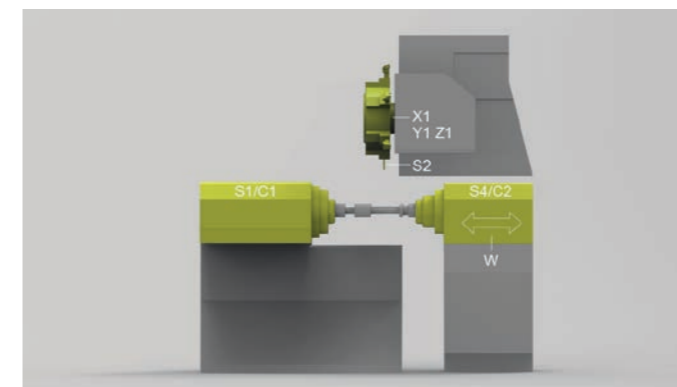

Single-setup machining: counter spindle (S3) with C axis (C2) on auxiliary axis (W) and driven tool (S2).

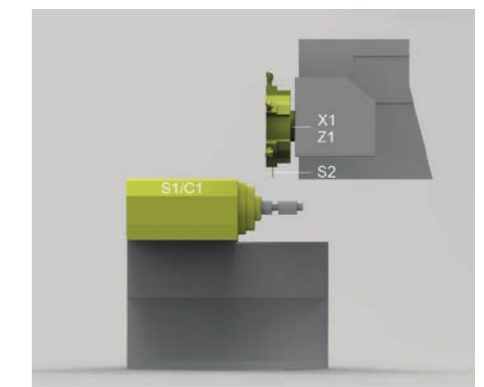

Spindle 1 (S1) with C axis (C1), as well as driven tool (S2)

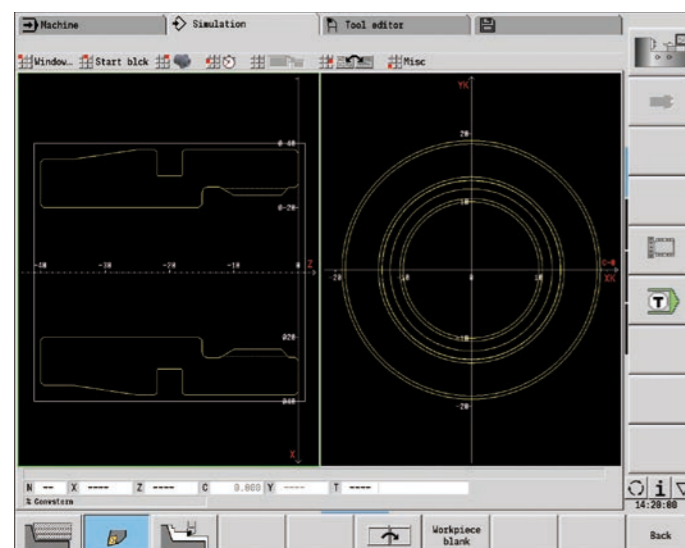

Graphical contour programming for C-axis machining (milling and drilling)

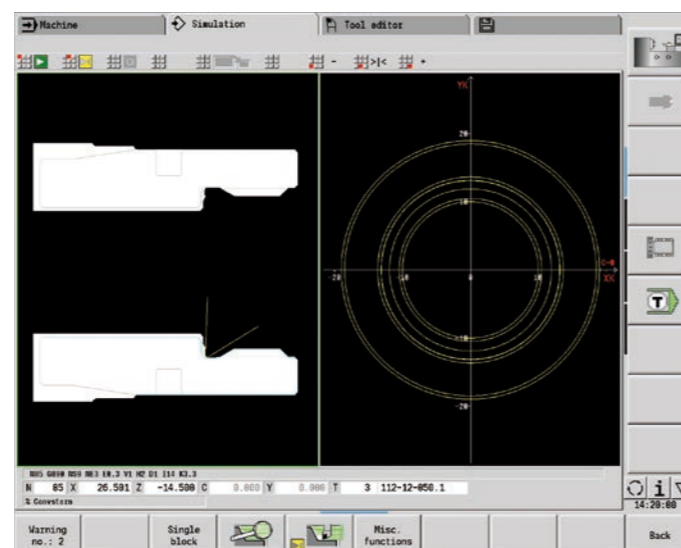

First clamping

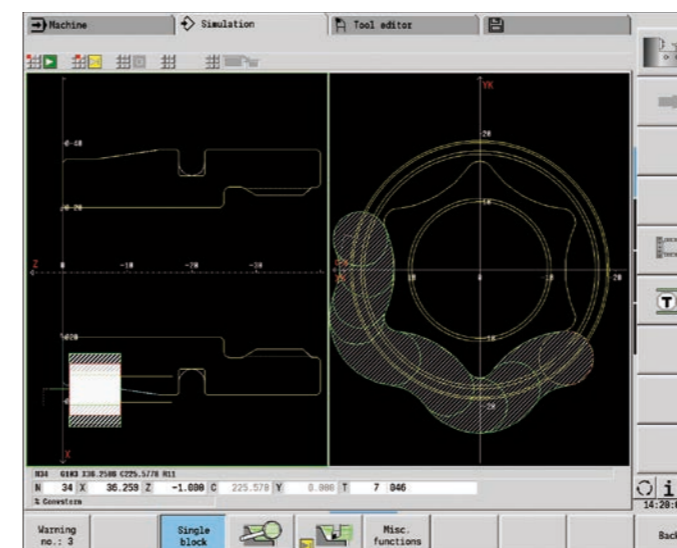

Rear-face machining on the counter spindle after automatic workpiece transfer



## Expandable for all cases

### Machining with the B axis and simultaneous machining

The B axis makes it possible to perform drilling and milling operations in oblique planes. At first glance, the programming work for these kinds of operations seems very complex and compute-intensive. But the CNC PILOT 640 lets you simply rotate the coordinate system to the desired angle and program the machining operation as usual in the main plane. The machine then executes the machining operation in the tilted working plane.

The B axis also features benefits for turning operations. By tilting the B axis and rotating the tool, you can bring the tool into positions that allow you to perform longitudinal and transverse machining on the main spindle and counter spindle with a single tool. You can thereby reduce the number of tools needed as well as eliminate certain tool changes.

#### Programming

The usual separation of the contour description and the machining operation on the CNC PILOT 640 also applies to drilling and milling operations in the tilted plane.

First, you rotate and shift the coordinate system so that it lies in the tilted plane. Then you define the hole pattern or the milling contour as you would in the YZ plane. The pattern and figure definitions of the CNC PILOT 640 are available to you in the process. This means that, for linear or circular patterns and simple figures (circles, rectangles, regular polygons, etc.), you only need a few entries to describe the pattern or figure in the tilted plane.

#### Simulation

In the Side View window, the simulation shows the hole pattern and milling contour perpendicularly to the tilted plane, and therefore without distortion. This ensures the easy verification of programmed hole patterns and milling contours. You can also verify the tool movements in the Side View window. If you want to check the machining operation in the tilted plane with respect to the turning contour or the front face, then add the Lathe Window or Front Window. In the position display, the CNC PILOT 640 shows the angle of the tilted plane and the tilt angle of the B axis (beneath the simulation window). Do you wish to view the currently active coordinate system? At a keystroke, the CNC PILOT 640 shows the current datum and direction of the valid coordinate system.

#### Flexible use of tools\*

If your machine is equipped with a B axis, then you can use your tools much more flexibly than before. On conventional lathes, you need four different tools for longitudinal and transverse turning on main and counter spindles, but you can perform these tasks with just a single tool when you employ a B axis.

You simply tilt the B axis and rotate the tool to the normal position or to the position for machining from behind the workpiece, whichever is required for longitudinal or transverse turning on the main or counter spindle. All you need is a single call: the CNC PILOT 640 calculates the tool lengths, the tool angle, and the other tool data for you.

Tool-use flexibility is increased significantly when multiple tools are mounted in one holder. If you have a combination of a roughing, finishing, and recessing tool, for example, then you can complete essential parts of the turning and recessing process on the main spindle and counter spindle without a tool change. And programming is very easy. You simply indicate which tooth of the tool to use and then define the tilting angle and the tool position. This is sufficient because the CNC PILOT 640 already has the rest position and the data of each tool tooth in its database.

This type of flexibility reduces the number of tools you need, and you save on machining time by reducing the number of tool changes.

\* The machine and the CNC PILOT 640 must be adapted for this function.

#### Simultaneous machining

The simultaneous roughing cycle and the simultaneous finishing cycle both adapt the inclination angle of the B axis to the workpiece contour during turning. During this process, the complex tool movements are continuously monitored in order to avoid collisions between the tool / tool holder and the workpiece. In simultaneous machining, the tool is continuously engaged at the optimal inclination angle, allowing you to attain perfect surfaces while increasing tool service life.



Machining in the tilted plane

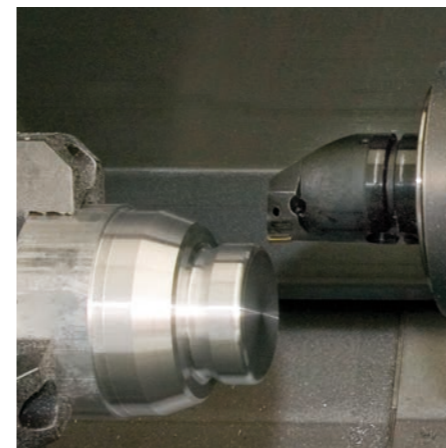

Facing and ...



... longitudinal turning with the same tool ...

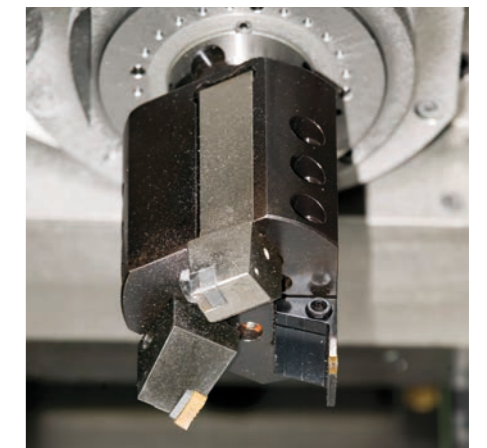

... and with multiple tools on one holder.

# High-performance Teach-in mode (option)

## Cycles, the pre-programmed working steps

### Workpiece machining in Teach-in mode

For simple, non-recurring tasks, rework, or thread repair, the cycles of the CNC PILOT 640 simplify your work.

The help images illustrate the few entries needed for the cycles. Before cutting, use the simulation to assure yourself that machining will run as planned.

### Thread-recut cycles

Even if the workpiece has been unclamped, you can easily recut the thread with the CNC PILOT 640.

Simply clamp the workpiece, and position the threading tool in the middle of a thread. The CNC PILOT 640 remembers this position along with the spindle angle. If you now position the tap in front of the workpiece and enter the other thread parameters, the CNC PILOT 640 has all the information it needs to recut this thread.

### Fewer calculations

In Teach-in mode as well, the CNC PILOT 640 automatically calculates the proportioning of cuts during roughing, recessing, recess turning, or thread cutting and calculates the number of strokes required for deep-hole drilling. When turning a taper, you can enter either the starting point and the end point or the starting point and the taper angle—whichever is shown on your drawing.

### Always available tool data

The CNC PILOT 640 uses a tool database. Tool data such as the cutting radius, tool angle, and point angle need to be entered only once for the setting dimensions to be determined. The CNC PILOT 640 saves the data. The next time you use the tool, simply call the tool number. The CNC PILOT 640 automatically considers the correct tool dimensions, and you can immediately machine to tolerance.

While a contour is being turned, the CNC PILOT 640 automatically compensates for the deviations arising from the cutter radius. This increases the precision of your workpiece.

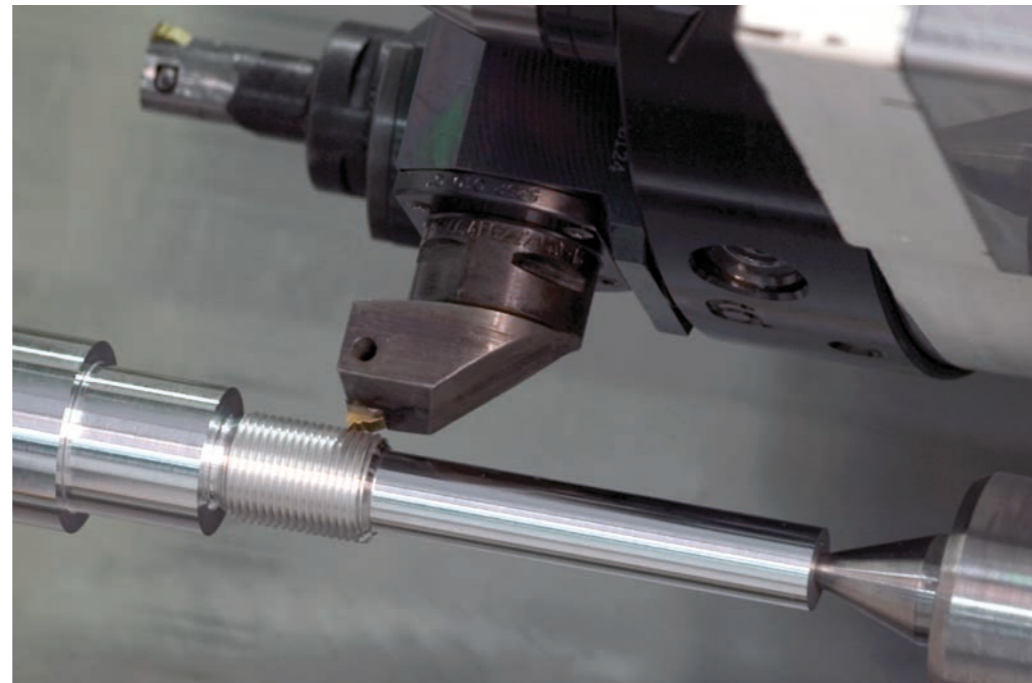

### Suggested technology data

The CNC PILOT 640 stores your cutting data based on the workpiece material, tool material, and type of machining operation. Because you have already entered the cutting material into the tool definition, you only need to enter the material of your workpiece. This provides the cycle with all of the data required for suggesting the cutting data.

### Reference points

You can define the **workpiece datum** by touching the workpiece with the tool or by entering the datum coordinates.

Approach the **tool-change point** once and store this position. Afterwards, a simple cycle call suffices in order to return to the tool change point.

### Protective zone for the spindle

For each traversing movement in the (-Z) direction, the CNC PILOT 640 checks whether the programmed protective zone is violated. If so, it stops the movement and issues an error message.

### Teach-in with contour follow-up

You can activate "contour follow-up" by defining a workpiece blank.

As a result, the current workpiece blank is known to every Teach-in cycle so that air cuts are avoided. This is possible with any kind of turning operation.



Single or multi-start longitudinal, taper, or API threads



Undercuts as per DIN 76, DIN 509 E, or DIN 509 F



Undercut form H, form K, or form U



Parting

Threads, undercuts, parting



Longitudinal/transverse cutting for simple contours



Longitudinal/transverse cutting with plunging



Longitudinal/transverse ICP cutting for any contours



Longitudinal/transverse ICP cutting for parallel contours

Turning: cutting and finishing



Radial/axial recessing for simple contours



Longitudinal/transverse recess turning for simple contours



Radial/axial ICP recessing for any contours



Longitudinal/transverse ICP recess turning for any contours

Recessing and recess turning: cutting and finishing

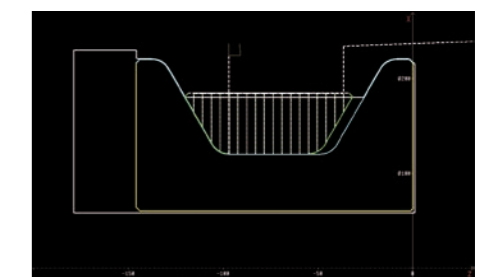
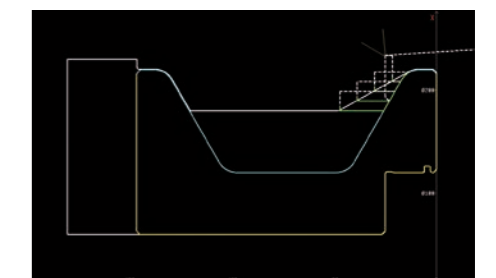
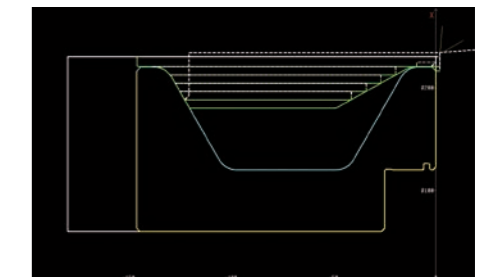

# Multi-channel machining with multiple slides

## Easily program complex machining

Regardless of whether multiple slides are machining a single workpiece or multiple workpieces are being machined simultaneously in the workspace, the challenge for the NC programmer is to optimally divide the machining operation between the available slides and spindles.

### Programming

The command set of the CNC PILOT 640 takes into account machining for complex machines. Special four-axis cycles and synchronization commands facilitate the creation of NC programs for machines with multiple slides. The assignment of program sections to slides or spindles gives the NC program a clear structure.

By mirroring and/or moving the contour, and by converting special NC commands, it is also easy to program turning operations that use the counter spindle, as well as rear-side drilling and milling operations, for nearly any machine design.

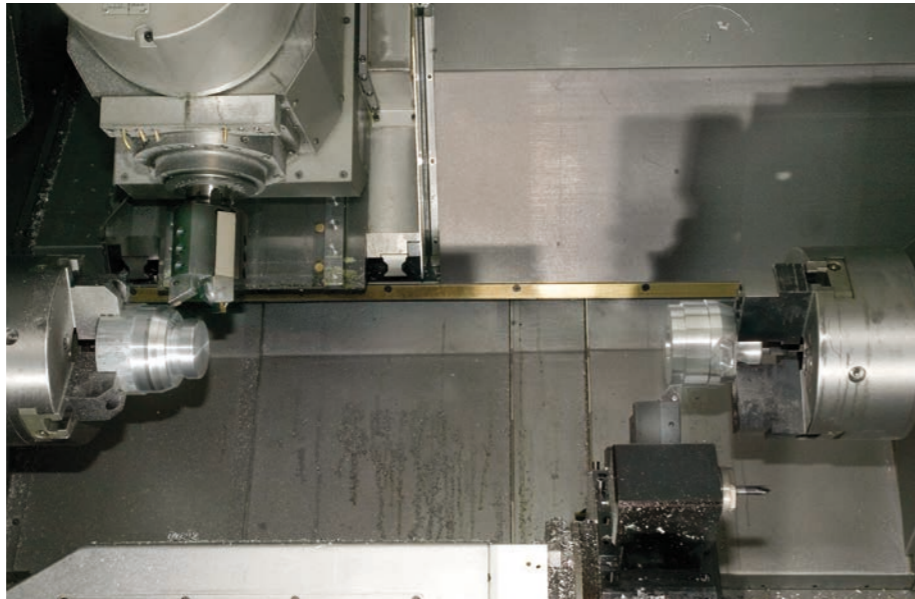

### Synchronous point analysis

Synchronous point analysis shows the chronological sequence of the machining operation and the interdependency of the slides.

During the simulation, the CNC PILOT 640 calculates the machining time, non-productive time, and waiting time, as well as all tool changes and synchronous points. Synchronous point analysis graphically depicts the times, tool changes, and synchronous points for each slide, making the machining sequence transparent. This is a good basis upon which the NC programmer can analyze and optimize the machining operation.

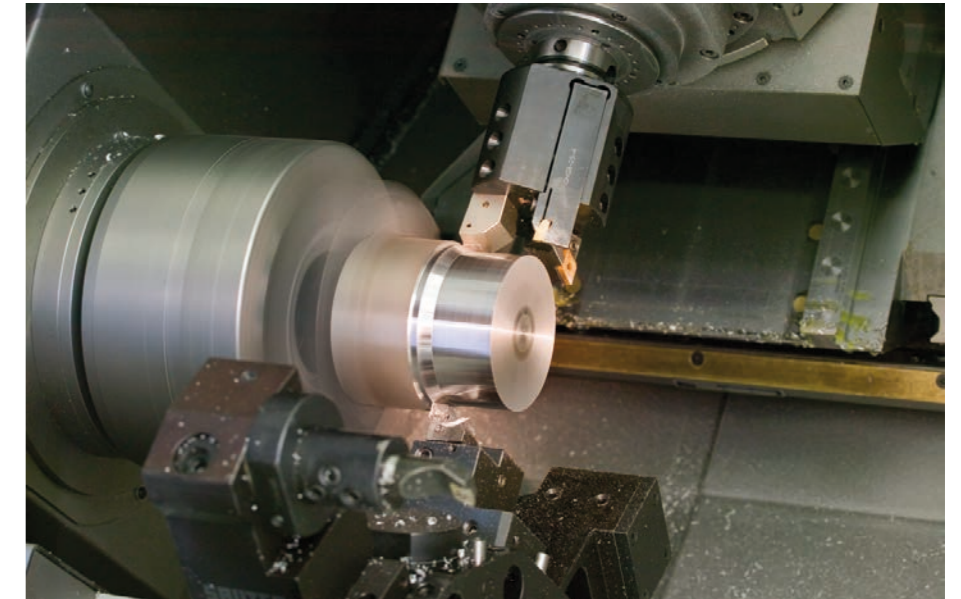

### Simulation

The graphical simulation shows all of the workpieces and the tool movements of all slides. The CNC PILOT 640 takes the entire work envelope into account. The tools and chucking equipment are shown to scale.

The graphical simulation also features a high degree of flexibility. You define what is displayed in the simulation window. You can specify whether the window for lathe, front-face or lateral machining is shown, or a combination of them. You can also specify whether only the NC blocks of a certain slide are displayed, or the NC blocks of all slides.

With this support, you can effectively and thoroughly check complex, multi-slide programs before making the first cut.

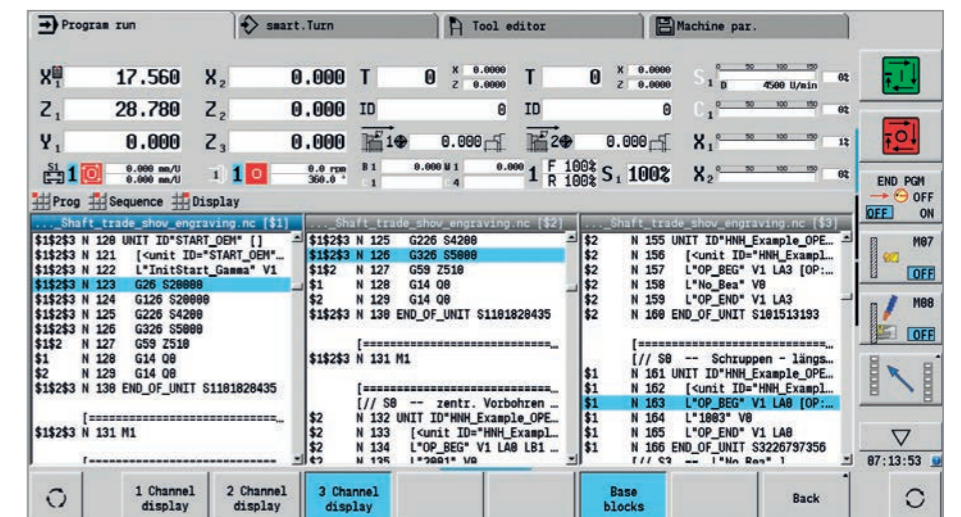
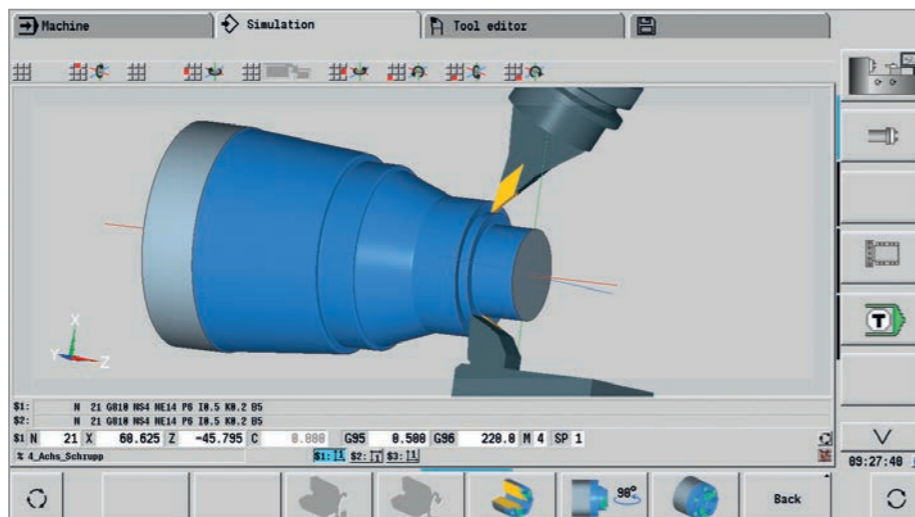

# Tool data and cutting data are readily available

## The tool and technology database of the CNC PILOT 640

### Tool database

The standard tool database of the CNC PILOT 640 stores 250 tools. This tool memory can be expanded to 999 tools (option). The CNC PILOT 640 differentiates between different types of turning, drilling, and milling tools. The data to be entered vary based on the tool type, ensuring that all of the important parameters are specified despite reduced data input.

The tool data are entered with the help of dialog prompts in which you enter parameters such as the cutting-edge radius, tool angle, point angle, cutting material, and tool description. The data to be input is explained through context-sensitive help images.

### Tool list

In the tool list, the CNC PILOT 640 presents you with the complete tool data in a clear format. Various sorting criteria can help you quickly find the desired tool.

This list not only gives you a good overview of your tools, but it also serves as the basis for transferring tool data during manual machining and for the creation of NC programs.

### Wear compensation

The CNC PILOT 640 can easily compensate for tool wear both in the X axis and in the Z axis. You can enter the compensation values at any time, even while the workpiece is being machined.

### Tool measurement

For measuring tools directly at the machine, the CNC PILOT 640 offers multiple possibilities:

- Via "touching off" the workpiece
- Via an optical gauge\* (option): the tool is manually moved into the crosshairs of an optical gauge, and the value is saved with a keystroke.
- Via a tool touch probe\* (option): the tool moves in the direction of measurement. Upon triggering of the tool touch probe (e.g., the TT 160 touch trigger probe) with a cuboid probe contact, the setting dimension can be determined and stored.

Using an optical gauge or tool touch probe for tool measurement makes determining the tool data particularly easy, reliable, and accurate.

\* The machine and CNC PILOT 640 must be adapted by the machine manufacturer for this function.

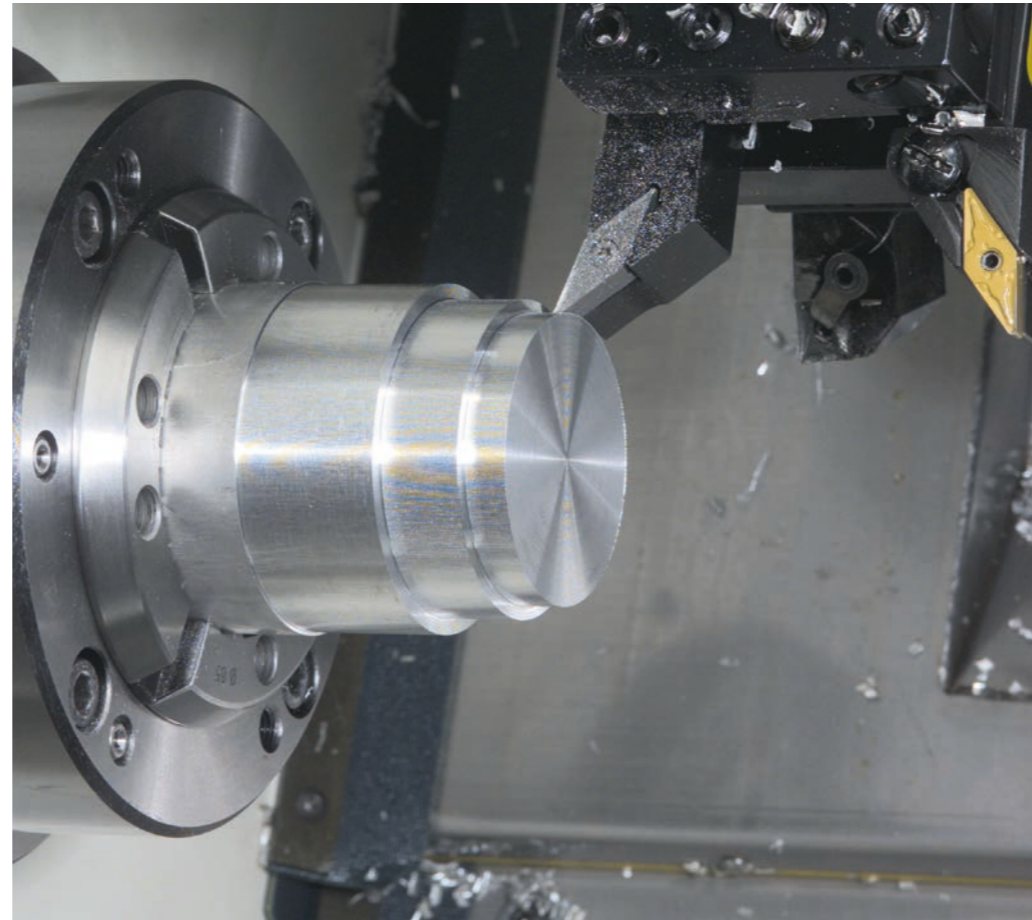

### Turret assignment

You can view your machine's programmed turret assignment with all of the important tool parameters at any time.

If you wish to change the tool assignment or the tools in the turret, you can also display the tool database entries in the lower window. Then you only need to select the desired turret pocket and the proper tool from the database. You can apply the tool data to the turret assignment entry at the stroke of a key.

### Tool life monitoring (option)

For smart.Turn and DIN PLUS programs, you can use the "Tool Life Monitoring with Replacement Tool" option along with simple tool life monitoring. The CNC PILOT 640 then automatically inserts a replacement tool as soon as the active tool is worn out. When the last tool in the tool sequence is worn out, the CNC PILOT 640 stops program execution.

### Technology Data (option)

With the CNC PILOT 640, cutting data need to be recorded only once. The control saves these data based on the criteria of workpiece material, cutting material, and type of machining operation. Thanks to this three-dimensional table, the control always knows the correct feed rate and the correct cutting speed.

The CNC PILOT 640 determines the type of machining operation based on the teach-in cycle or the unit. The cutting material is entered with the tool description. Now all you need to do is declare the material at the start of your cycle program or smart.Turn program, and the CNC PILOT 640 suggests the correct values for your machining operation. You can use the cutting values or modify them as needed.

By default, the technology database of the CNC PILOT 640 stores the cutting data for nine combinations of workpiece materials and tool materials. It can be expanded to up to a total of 62 combinations (option). Every combination of workpiece material and tool material contains the cutting speed, the main feed rate and secondary feed rate, and the infeed for 16 types of machining operation.

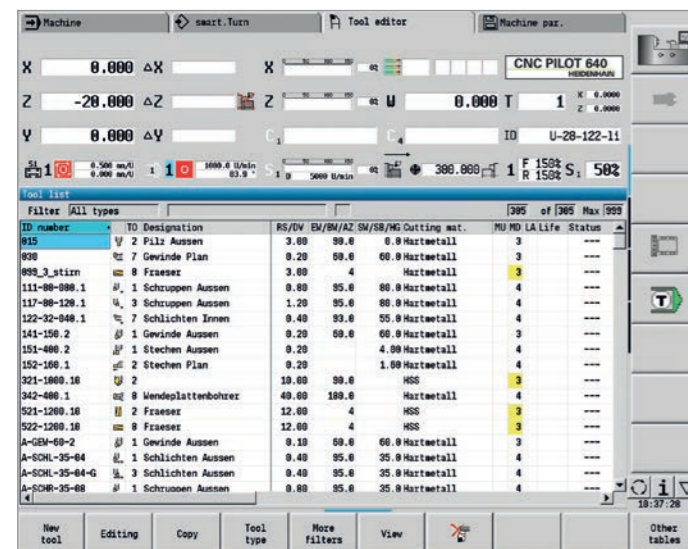

Tool management in the tool list

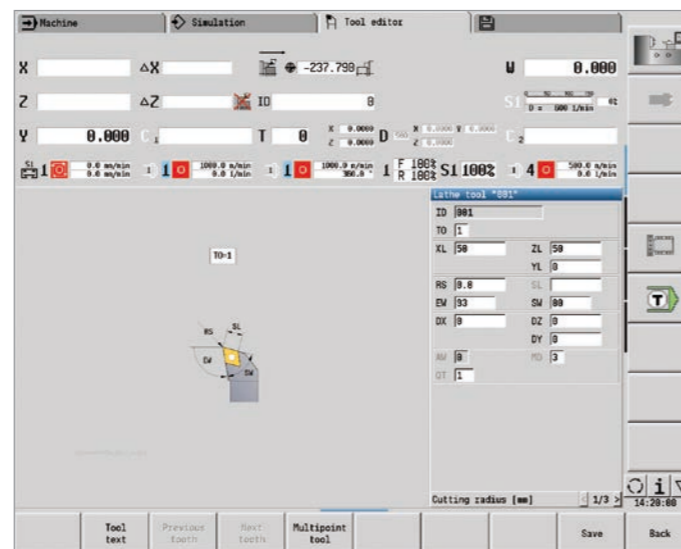

Tool editor

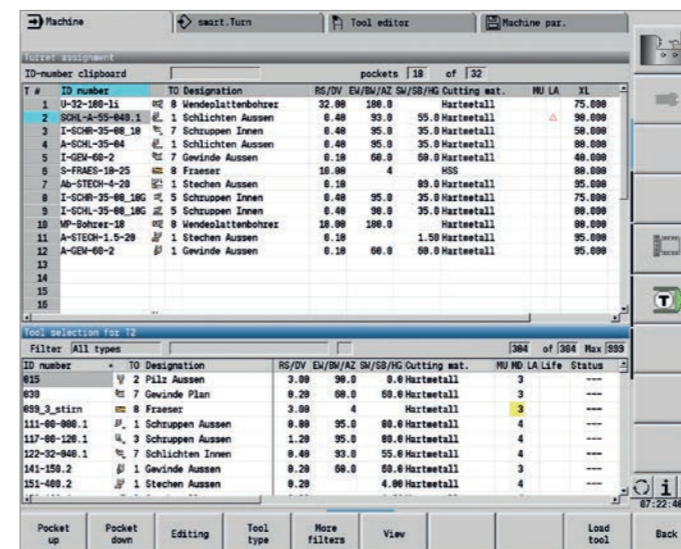

Tool selection for turret assignment

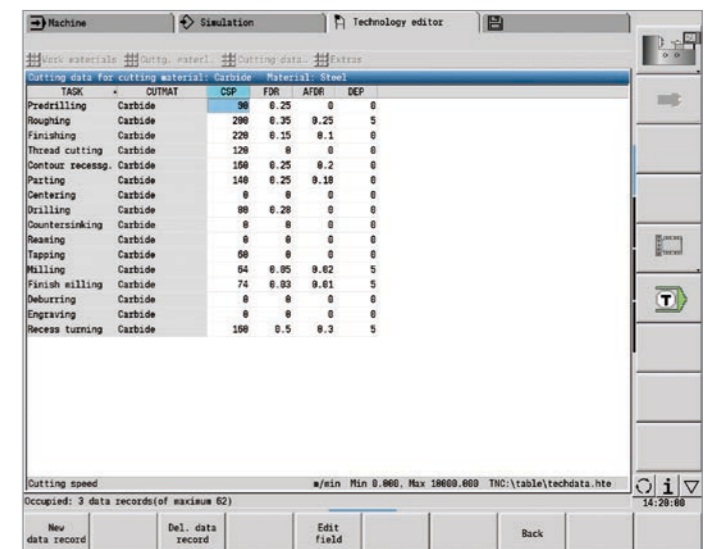

Input of cutting values in the technology editor



# Open for external information

## Fully digital job management with Connected Machining

The smooth exchange of knowledge is crucial for the success of a company. In order for knowledge to be transferred rapidly and without loss, e-mail communication capability is just as important as the continuous availability of electronic production documents or the transfer of data to ERP and production-activity control systems. Tool and raw material inventories, tool data, workholding drawings, CAD data, NC programs, and inspection instructions must all be available to machine operators on all shifts. Cost-effective manufacturing therefore requires an efficient process chain and a networked control.

The CNC PILOT 640, with its **Connected Machining** package of functions, integrates itself flexibly into your process chain and helps you to optimize the transfer of knowledge within your company. So let your workshop, as well, benefit from all of

the information available within your company. **Connected Machining** makes uniformly digital job management possible within a networked manufacturing environment. You thereby benefit from the following:

- Ease of data usage
- Time-saving procedures
- Transparent processes

### The networked CNC PILOT 640

Integrate the CNC PILOT 640 with the functions of **Connected Machining** into your corporate network and, via the control, connect the shop floor to PCs, programming stations, and other data storage media in these areas of the company:

- Design
- Programming
- Simulation
- Production planning
- Production

Even the basic version of the CNC PILOT 640 is equipped with two Gigabit Ethernet ports of the latest generation. The CNC PILOT 640 communicates with NFS servers and Windows networks in the TCP/IP protocol without additional software. The fast data transfer of up to 1000 Mbit/s ensures very short transmission times. The CNC PILOT 640 therefore offers the optimal technological platform for **Connected Machining**, the networking of the control in the shop with all production-related areas of your company.

### Standard range of functions

In order for you to be able to use the data that you have transferred to the CNC PILOT 640 via the standard network connection, the CNC PILOT 640 offers attractive applications, even in its standard range of functions. The PDF viewer or Mozilla Firefox web browser enable the simplest form of **Connected Machining**: access to production process data directly on the control. As a result, operating web-based documentation and ERP systems is just as easy as accessing your e-mail account. The following other file formats can also be opened directly on the CNC PILOT 640:

- Text files ending in .txt or .ini
- Graphics files ending in .gif, .bmp, .jpg, or .png
- Table files ending in .xls or .csv
- HTML files

### Data transfer with Connected Machining

Another solution for full digital job management from **Connected Machining** is the free-of-charge **TNCremo** PC software. With it, you can

- bidirectionally transfer remotely stored part programs and tool or pallet tables, including over the Ethernet, and
- start the machine.

With the powerful **TNCremoPlus** PC software, you can also transfer the screen contents of the control to your PC using the live-screen function.

### Job-related data

With **REMOTE DESKTOP MANAGER (option 133)**, you can operate a Windows PC from the CNC PILOT 640. On the control, you gain direct access to EDP systems within the process chain and make your machine setup processes significantly more efficient by reducing inconvenient legwork between the machine and the office. Technical drawings, CAD data, NC programs, tool data, work instructions, parts lists, and warehouse information are digitally available at the machine. E-mails can be sent and received with ease. With a simple keystroke on the machine operating panel, you can switch between the control screen and the screen of the Windows PC. The PC can be a computer in the local network or an industrial PC (IPC) in the electrical cabinet of the machine.

### Detailed data for the optimal organization of production processes

**HEIDENHAIN DNC<sup>1)</sup>** enables, among other things, the connection of CNC PILOT controls to inventory management and production-activity control systems. Automatic feedback messages about currently running production processes, for example, can be set up over this interface.

<sup>1)</sup> The machine must be adapted by the machine manufacturer for this function.

One aspect of Connected Machining is the **StateMonitor<sup>2)</sup>** PC software, which gives you access to the status of the current machining operation. You can use the software with any device that has a web browser. This allows you to use StateMonitor not only on your control or PC but also on your smartphone or tablet. On a well-designed display, you can quickly gain an overview of the current machine status or see whether any machine messages are pending. This allows you

to react immediately and take appropriate action. You can also easily configure StateMonitor to send you an e-mail for specific events, such as at the end of a program, for a machine stop, or for a servicing message.

<sup>2)</sup> Option 18 is required

### Component monitoring

During their lifecycle, load-sustaining machine components such as guideways and ball screws exhibit wear, thus causing the quality of axis motion to diminish. This, in turn, affects production quality. With Component Monitoring (option 155) and a cycle, the control is able to measure the current condition of the machine. As a result, any deviations from the machine's shipping condition due to wear and aging can be measured. The machine manufacturer can read and evaluate the data, and react using predictive maintenance, thereby avoiding unplanned machine downtimes.

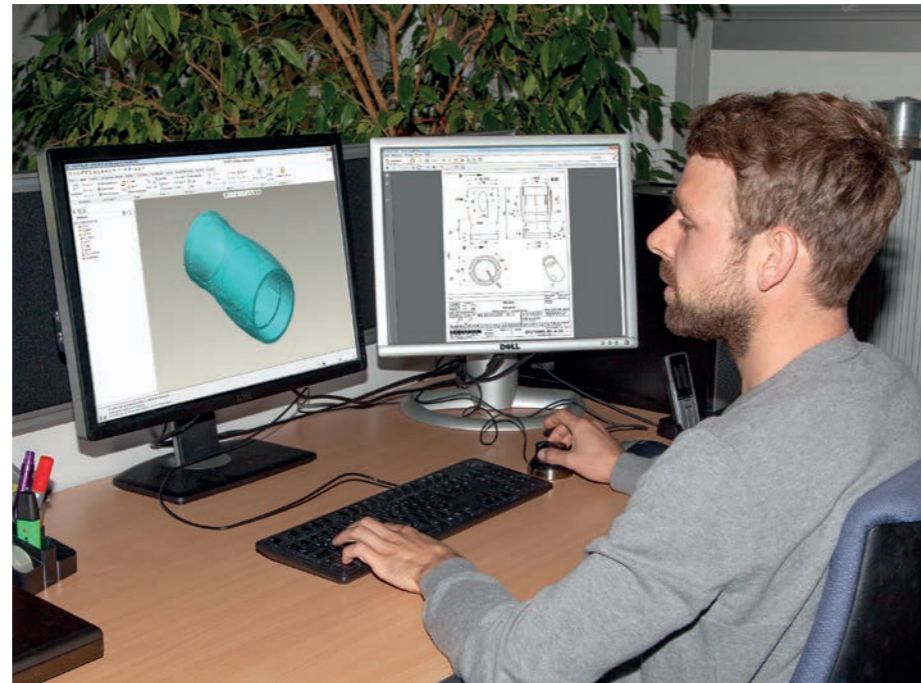
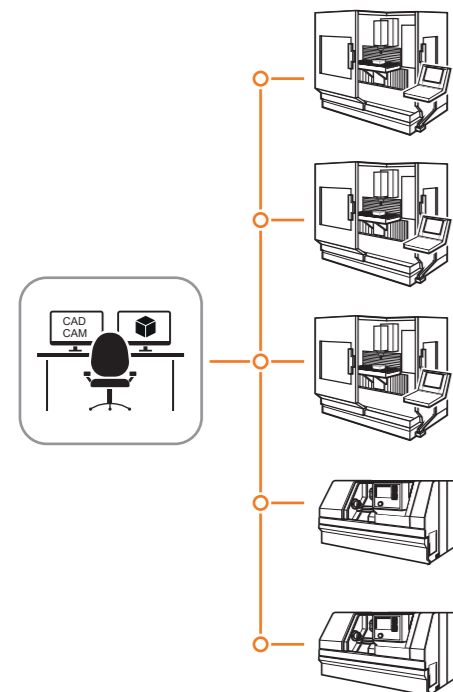

# Open for external information

## The DataPilot CP 640 programming station

DataPilot CP 640 is the PC programming station for the CNC PILOT 640 and is the organizational system for the shop floor and master tradesman's office.

DataPilot CP 640 is the ideal complement to the CNC PILOT 640 for program creation, archiving, and training.

### Creating programs

Programming, testing, and optimizing smart.Turn or DIN PLUS programs with the programming station significantly reduces machine idle times. This does not require a major shift in thinking, because, with DataPilot, programming and testing are performed in the same manner as on the lathe. DataPilot is based on the same software that is in the control. This also gives you the assurance that a program created with DataPilot can be immediately run on the machine.

### Archiving programs

Although the CNC PILOT 640 has a large memory capacity, we recommend saving the created program on an external system as well. The CNC PILOT 640 has a USB and an Ethernet interface. This gives you everything you need in order to integrate the CNC PILOT 640 into your existing network or to connect the DataPilot PC directly with the control.

Convenient program transfer functions support programming as well as archiving on the DataPilot PC.

### Training with DataPilot CP 640

Because DataPilot CP 640 is based on the same software as the CNC PILOT 640, it is ideally suited for training purposes. Programming and program testing on the DataPilot PC are performed in exactly the same way as on the machine. Even setup functions such as defining the workpiece datum, measuring tools, running individual cycles, or executing smart.Turn or DIN PLUS programs are simulated with DataPilot. This gives trainees the confidence they will need for later work on the machine.

### System requirements

The DataPilot software can run on PCs with the Windows 7, 8, 8.1, or Windows 10 (64-bit) operating systems.

# Rapid availability of all information

Do you have questions about a programming step, but your User's Manual is not at hand? That's not a problem: The CNC PILOT 640 and DataPilot CP 640 feature the convenient TURNguide help system with which the user documentation can be displayed in a separate window.

You activate TURNguide by simply pressing the Info key on the keyboard.

In most cases, TNCguide directly displays the information in the proper context (context-sensitive help). This means that you immediately receive the information that you need. This function is particularly helpful when you program cycles. The cycle's principle of operation is explained as soon as you press the Info key in an open dialog box.

You can download the documentation in the desired language from the HEIDENHAIN homepage to the corresponding language directory on your control.

The help system contains the following manuals:

- CNC PILOT 640 User's Manual
- smart.Turn and DIN Programming User's Manual
- DataPilot CP 640 user's manual (installed only with a programming station)

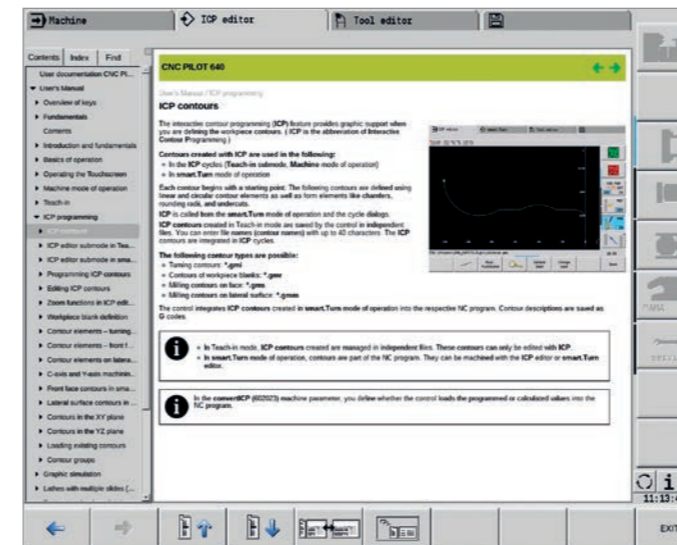
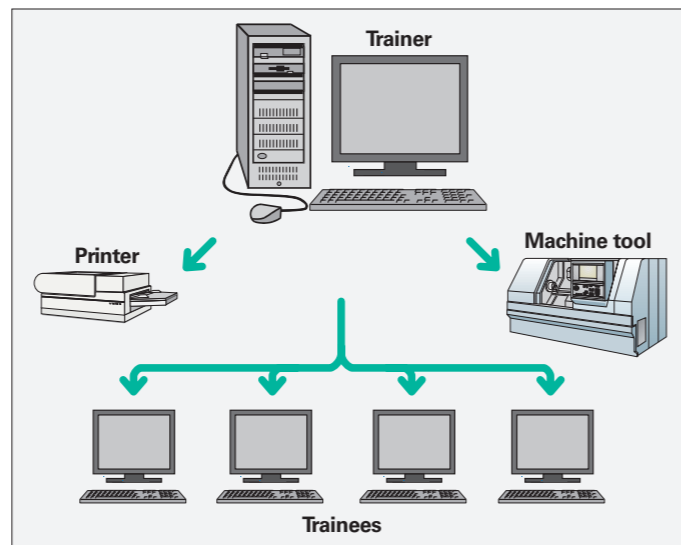
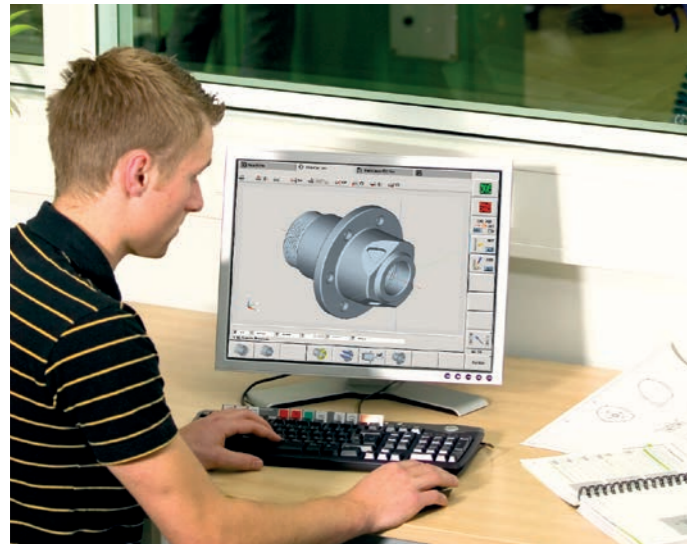

TURNguide integrated into the control, e.g., on the CNC PILOT 640 ...

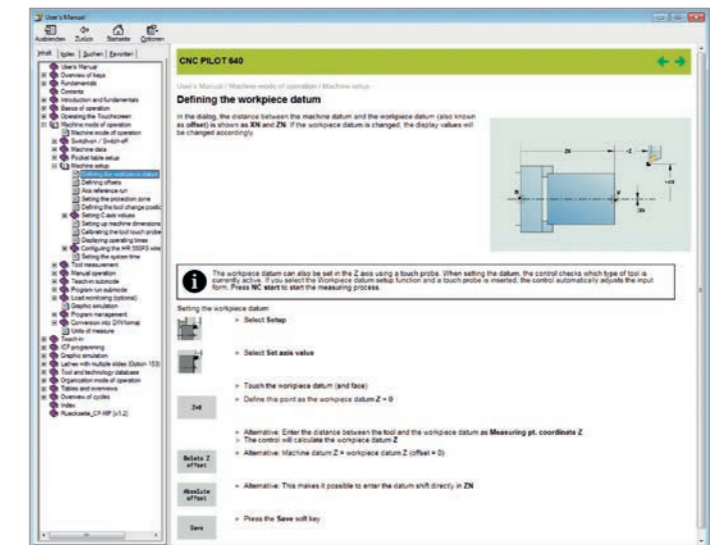

... or on the programming station.

## Measuring workpieces

Machine setup, setting presets, and measuring with touch trigger probes

### Inspecting workpieces for completed machining and dimensional accuracy

The CNC PILOT 640 features measuring cycles for checking the geometry of the machined workpieces. To do this, simply insert a 3D touch probe from HEIDENHAIN into the turret instead of a tool:

- Check whether all of the machining operations have been properly performed
- Determine infeeds for finishing
- Detect and compensate for tool wear
- Inspect workpiece geometry and sort parts
- Log measured data
- Ascertain the machining trend

The workpiece touch probes from HEIDENHAIN help reduce costs in the shop and for serial production. Setup, measurement, and control functions can be automatically executed in conjunction with the touch probe cycles of the CNC PILOT 640.

The stylus of a TS touch trigger probe is deflected upon contact with a workpiece surface. In that instant, the TS generates a triggering signal that, depending on the model, is transmitted to the control either by cable, radio transmission, or an infrared beam.

HEIDENHAIN touch probes\* for workpiece measurement are available in various designs. The ball tips, which are made of ruby, are available in different diameters and with various stylus lengths.

\* The touch probes must be adapted to the CNC PILOT 640 by the machine manufacturer.

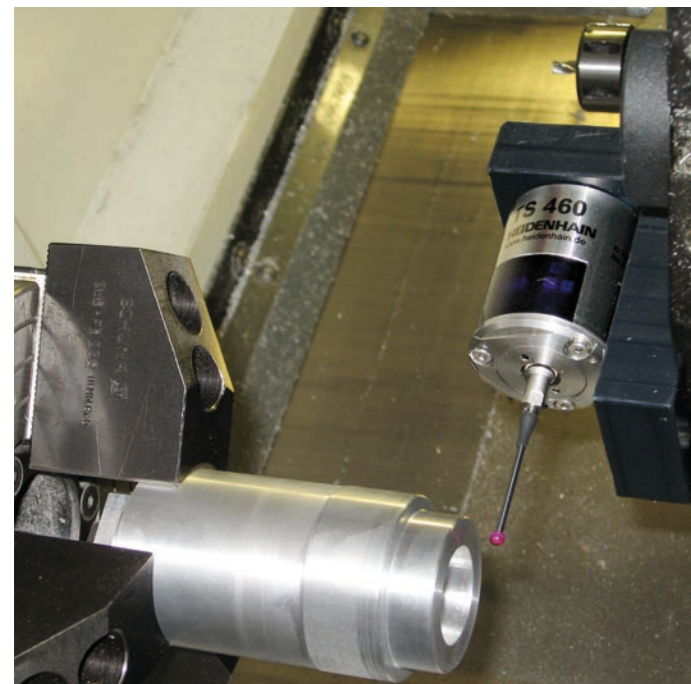

### Further information:

You can find detailed descriptions of workpiece touch probes on the Internet at [www.heidenhain.com](http://www.heidenhain.com) or in the *Touch Probes for Machine Tools* brochure.

## Tool measurement

Determine the length, radius, and level of wear directly in the machine

Exact measurement of the tool dimensions is a decisive factor in ensuring a consistently high level of production quality. The TT tool touch trigger probes from HEIDENHAIN serve this purpose.

**TT 160**: new generation, signal transmission to the NC via a cable

**TT 460**: new generation, signal transmission to transceiver via radio and infrared beam

The SE 660 is a transceiver for tool and workpiece touch probes using radio or infrared transmission.

The TT 160 and TT 460 are 3D touch trigger probes for the measurement and inspection of tools. The disk-shaped probe contact of the TT is deflected during tactile probing of a tool. In that instant, the TT generates a trigger signal that is transmitted to the control, where it is then further processed. The trigger signal is generated by means of a wear-free and highly reliable optical sensor.

Thanks to its robust design and high protection rating, these tool touch probes can be installed in the machining envelope of the machine tool, where they enable tool measurement directly inside the machine. Fast, easy, and particularly precise tool measurement is the result. The tool touch probes from HEIDENHAIN are an ideal addition for improving the efficiency and quality of your production system.



TS 460



SE 660



TT 160

### Further information:

You can find detailed descriptions of tool touch probes on the Internet at [www.heidenhain.com](http://www.heidenhain.com) or in the *Touch Probes for Machine Tools* brochure.

# Overview

## User functions

User functions	Standard	Option	
<b>Configuration</b>	•	0-6 55+0-6 70+0-6 54+0-6 94+0-6 132+0-6	Basic version: X and Z axis, main spindle Driven tool and auxiliary axes (U, V, W) C axis and driven tool Y axis B axis Parallel axes U, V, W (display function and compensation) Counter Spindle Digital current and speed control
<b>Operating modes</b>			
Manual operation	•	11	Manual slide movement through axis-direction keys, an intermediate switch, or electronic handwheels Graphical support for entering and running cycles without storage of the machining steps, in direct alternation with manual machine operation Thread rework (thread repair) in a second workpiece setup
Teach-in mode		8	Sequential arrangement of fixed cycles, with each cycle being run immediately after input or graphically simulated and subsequently saved
Program run	•	9 8	In Single Block mode or Full Sequence mode: DIN PLUS programs smart.Turn programs Cycle programs
Setup functions	•	17 17 17	Setting the workpiece datum Defining the tool-change point Defining the protection zone Defining machine dimensions Manual programs Tool measurement by touching the workpiece Tool measurement with a TT tool touch probe Tool measurement with an optical gauge Workpiece measurement with a TS workpiece touch probe
<b>Programming</b>			
Cycle programming		8 8 8 8 8 8 8 8 8 8 8+55 8+55 8+55 8+55 8+55 8 8 8 8 8+9	Turning cycles for simple or complex contours, and contours described with ICP Contour-parallel turning cycles Recessing cycles for simple or complex contours, and contours described with ICP Repetitions with recessing cycles Recess turning cycles for simple or complex contours, and contours described with ICP Undercut and parting cycles Engraving cycles Threading cycles for single or multi-start longitudinal, taper, or API threads, and threads with variable pitch Cycles for axial and radial drilling, deep-hole drilling, and tapping operations with the C axis Thread milling with the C axis Axial and radial milling cycles for slots, figures, single surfaces, and centric polygon surfaces, and for complex contours described with ICP for machining with the C axis Helical slot milling (multi-start) with the C axis Deburring of ICP contours Linear and circular patterns for drilling and milling operations with the C axis Context-sensitive help images Transfer of cutting values from the technology database Use of DIN macros in cycle programs Conversion of cycle programs to smart.Turn programs

User functions	Standard	Option	
Interactive Contour Programming (ICP)		8/9 8/9 8/9 8/9 8/9 8/9 8/9 8/9 8/9 8/9+55	Contour definition with linear and circular contour elements Immediate display of entered contour elements Calculation of missing coordinates, intersections, etc. Graphical display of all solutions for selection by the user if more than one solution is possible Chamfers, rounding arcs, and undercuts available as form elements Input of form elements immediately during contour creation or through later superimposition Changes to existing contours can be programmed Machining attributes available for individual contour elements C-axis machining on the front face and lateral surface: • Description of individual holes and hole patterns (only in smart.Turn) • Description of figures and figure patterns for milling (only in smart.Turn) • Creation of freely definable milling contours
		9+70	Y-axis machining on the XY and ZY planes (only in smart.Turn): • Description of individual holes and hole patterns • Description of figures and figure patterns for milling operations • Creation of freely definable milling contours
		8/9+55+70+132 8/9+42	Programming of the rear face for complete machining with the C and Y axes DXF Import: importing of contours for lathe and milling operations
smart.Turn programming		9 9 9 9 9 9 9 9 9 9 9+55/70 9+55/70 9+55+135 9+55 9+55/70	The basis is the "unit," which is the complete description of a machining block (geometry, technology, and cycle data) Dialog boxes divided into overview and detail forms Fast navigation between the forms and the input groups via the "smart" keys Context-sensitive help images Start unit with global settings Transfer of global values from the start unit Transfer of cutting values from the technology database Units for all turning and recessing operations for simple contours and ICP contours Units for drilling and milling operations with the C or Y axis for holes, milling contours, and drilling and milling patterns that are simple or that have been programmed with ICP Units for trochoidal milling operations for pockets and slots Unit for hobbing (machining of gear teeth) Special units for activating/deactivating the C axis, as well as for subroutines and section repeats Verification graphics for the workpiece blank and finished part, as well as for C- and Y-axis contours
		9 9 9 9 9 9 9 9 9	Turret assignment and other setup information in the smart.Turn program Parallel programming Parallel simulation Trochoidal milling Hobbing Multiple plunging Batch Mode (automatic execution of multiple different main programs)
TURN PLUS		63	Automatic smart.Turn program generation with: • Automatic tool selection • Automatic turret assignment • Automatic calculation of the cutting data • Automatic generation of the machining sequence in all working planes, including for C-axis machining (with option 55) and Y-axis machining (with option 70) • Automatic cutting limit through chucking equipment • Automatic generation of work blocks for rechucking during complete machining • Automatic generation of work blocks for rear-face machining (with option 132)

# Overview

## User functions (continued)

User functions	Standard	Option	
DIN PLUS programming	•		Programming in DIN 66025
	•		Expanded command format (IF ... THEN ... ELSE ...)
	•		Simplified geometry programming (calculation of missing data)
	•		Powerful fixed cycles for area clearance, recessing, recess turning, and thread machining
		55	Powerful fixed cycles for drilling and milling with the C axis
		70	Powerful fixed cycles for drilling and milling with the Y axis
	•		Subprograms
	•		Technology functions for complete machining:
	•		• Traversing to a fixed stop
	•		• Controlled parting
		131/132	• Spindle synchronism
		132	• Mirroring and converting
			• Mechatronic tailstock
	•		Programming with variables
		8/9	Contour description with ICP
	•		Program verification graphics for workpiece blank and finished part
	•		Turret assignment and other setup information in the DIN PLUS program
		9	Conversion of smart.Turn units into DIN PLUS command sequences
	•		Parallel programming
	•		Parallel simulation
<b>Simulation</b>	•		Graphical simulation of the cycle process, the cycle program, the smart.Turn program, or the DIN PLUS program
	•		Depiction of the tool paths as pencil-trace or cutting-path graphics; special identification of the rapid traverse paths
	•	55	Machining simulation (2-D material-removal graphics)
	•		Side view or front face view, or 2-D view of (unrolled) cylindrical surface for verification of C-axis machining operations
	•	54	Display of programmed contours
	•		View of the tilted plane (B-axis machining)
	•		View of front face and YZ plane for verification of Y-axis machining
	•		Three-dimensional rendering of the workpiece blank and finished part
		132	Simulation of mirrored contours for rear-face machining
	•		Shifting and magnifying functions
	•		Block scan in the simulation
	•		Depiction of multi-channel machining operations
<b>Concurrent simulation</b>	•		Real-time depiction of currently running workpiece machining
<b>B-axis machining</b>	•	54	Machining with the B axis
	•	54	Tilting the working plane
		9+54	Rotating the machining position of the tool
			Simultaneous turning
<b>Eccentric machining</b>		135	Cycles for eccentric turning and for the manufacture of oval and polygonal contours
		135	Superimpositioning of traversing movements of the X and Y axes synchronously to the rotational motion of the spindle
<b>Machining time analysis</b>	•		Calculation of machining times and idle times
	•		Consideration of the switching commands triggered by the CNC
	•		Representation of time per individual cycle or per tool change
<b>Monitoring function</b>		151	Load monitoring: detection of tool wear and breakage during machining
		155	Component Monitoring: monitoring of component wear and overloading

User functions	Standard	Option	
<b>Tool database</b>	•	10	For 250 tools
	•		For 999 tools
	•		Tool description can be entered for every tool
	•		Automatic inspection of the tool-tip position relative to the machining contour
	•		Compensation of the tool-tip position in the X/Y/Z plane
	•		Fine compensation of tool via handwheel with application of compensation values in the tool table
	•		Automatic tool-tip and cutter radius compensation
	•		Tool monitoring for the service life of the indexable insert or of the number of produced workpieces
		10	Tool monitoring with an automatic tool change after expiration of tool life
	•		Management of multipoint tools (multiple inserts or reference points)
	•		Support of quick-change tool systems
<b>Technology database</b>		8/9	Access to cutting data upon definition of workpiece material, cutting material, and the type of machining operation. The CNC PILOT 640 differentiates between 16 types of machining operations. Every combination of workpiece material and tool material contains the cutting speed, the main feed rate, the secondary feed rate, and the infeed for 16 types of machining operation.
		8/9	Automatic determination of the type of machining operation from the cycle or the machining unit
		8/9	The cutting data are entered in the cycle or in the unit as suggested values
		8/9	Nine combinations of workpiece material and tool material (144 entries)
		10	62 workpiece-material / tool-material combinations (992 entries)
<b>User administration</b>	•		Configurable linkage of permissions to user roles
			• Logging on to the control with a user account
			• User-specific HOME folder for simplified data management
			• Role-based access to the control and network data
<b>Conversational languages</b>	•		English, German, Czech, French, Italian, Spanish, Portuguese, Dutch, Swedish, Danish, Finnish, Norwegian, Slovenian, Slovak, Polish, Hungarian, Russian (Cyrillic), Romanian, Turkish, Chinese (traditional and simplified), Korean

# Overview

## Options

Option number	Option	Starting with NC-Software 688946-688947-	ID	Comment
0 1 2 3 4 5 6 7	Additional Axis	01 01 01 01 01 01 03	354540-01 353904-01 353905-01 367867-01 367868-01 370291-01 307292-01 370293-01	<b>Additional control loops 1 to 8</b>
8	Teach-In	01	632226-01	<b>Cycle programming</b> <ul style="list-style-type: none"> <li>Contour description with ICP</li> <li>Cycle programming</li> <li>Technology database with nine workpiece-material / tool-material combinations</li> </ul>
9	smart.Turn	01	632227-01	<b>smart.Turn</b> <ul style="list-style-type: none"> <li>Contour description with ICP</li> <li>Programming with smart.Turn</li> <li>Technology database with nine workpiece-material / tool-material combinations</li> </ul>
10	Tools and Technology	01	632228-01	<b>Tools and technology</b> <ul style="list-style-type: none"> <li>Tool database expanded to 999 entries</li> <li>Technology database expanded to 62 workpiece-material / tool-material combinations</li> <li>Tool life monitoring with exchange tools</li> </ul>
11	Thread Recutting	01	632229-01	<b>Threads</b> <ul style="list-style-type: none"> <li>Thread recutting</li> <li>Handwheel superimpositioning during thread cutting</li> </ul>
17	Touch Probe Functions	01	632230-01	<b>Tool measurement and workpiece measurement</b> <ul style="list-style-type: none"> <li>Determining tool-setting dimensions with a tool touch probe</li> <li>Determining tool-setting dimensions with an optical gauge</li> <li>Automatic workpiece measurement with a workpiece touch probe</li> </ul>
18	HEIDENHAIN DNC	01	526451-01	Communication with external PC applications over COM component
24	Gantry Axes	01	634621-01	Gantry axes via master-slave torque control
42	DXF Import	01	632231-01	<b>DXF import:</b> importing of DXF contours
46	Python OEM Process	01	579650-01	Python application on the CNC PILOT 640
49	Double-Speed Axes	01	632223-01	Short control-loop cycle times for direct drives
54	B-Axis Machining	01	825742-01	<b>B axis:</b> tilting the working plane, rotating the machining position of the tool
55	C-Axis Machining	01	633944-01	<b>C-axis machining</b>
63	TURN PLUS	01	825743-01	<b>TURN PLUS:</b> automatic generation of smart.Turn programs
70	Y-Axis Machining	01	661881-01	<b>Y-axis machining</b>
77	4 Additional Axes	03	634613-01	<b>4 additional control loops</b>
78	8 Additional Axes	03	634614-01	<b>8 additional control loops</b>

Option number	Option	Starting with NC-Software 688946-688947-	ID	Comment
94	Parallel Axes	01	679676-01	<b>Support for parallel axes (U,V,W)</b> Combined display of principle and secondary axes
131	Spindle Synchronism	01	806270-01	<b>Synchronization</b> (of two or more spindles)
132	Counter Spindle	01	806275-01	<b>Counter spindle</b> (spindle synchronism, rear-face machining)
133	Remote Desktop Manager	04	894423-01	Display and remote operation of external computer units (e.g., a Windows PC)
135	Synchronizing Functions	03	1085731-01	Advanced synchronization of axes and spindles
137	State Reporting	06	1232242-01	State Reporting Interface (SRI): provision of operating conditions
143	Load Adapt. Control	01	800545-01	LAC: load-dependent adaptation of control parameters
151	Load Monitoring	03	1111843-01	Monitoring of the tool load
153	Multi-channel	05	1217032-01	Multi-channel capability: up to three channels for asynchronous multi-slide machining
155	Component Monitoring	07	1226833-01	Monitoring for component overloading and wear
160 to 167	Integrated FS	07		Enabling of functional safety (FS) and safe control loops
169	Add. FS Full	08		Enabling of remaining safe control loops

Accessories	
<b>Electronic handwheels</b>	<ul style="list-style-type: none"> <li>• <b>HR 180</b> panel-mounted handwheels with connection to position inputs, and</li> <li>• An <b>HR 130</b> serial panel-mounted handwheel or a portable serial <b>HR 510 (FS)</b>, <b>HR 520 (FS)</b>, <b>HR 550 FS</b> handwheel</li> </ul>
<b>Tool measurement</b>	3D touch trigger probes: <ul style="list-style-type: none"> <li>• <b>TT 160</b> with a cuboid probe contact and cable connection</li> <li>• <b>TT 460</b> with a cuboid probe contact and radio or infrared transmission</li> </ul>
<b>Workpiece measurement</b>	<ul style="list-style-type: none"> <li>• <b>TS 150, TS 248, TS 260</b>: touch trigger probe with cable connection, or</li> <li>• <b>TS 460</b> touch trigger probe with radio or infrared transmission, or</li> <li>• <b>TS 740</b> touch trigger probe with infrared transmission</li> </ul>
<b>DataPilot CP 640, MP 620</b>	Programming station for PC for programming, archiving, and training for the CNC PILOT 640 <ul style="list-style-type: none"> <li>• Full version with license for single station or multiple stations</li> <li>• Demo version (free of charge)</li> </ul>
<b>Software for PCs</b>	<ul style="list-style-type: none"> <li>• <b>TeleService</b> software for remote diagnostics, monitoring, and operation</li> <li>• <b>TNCremo</b> software for data transfer—free of charge</li> <li>• <b>TNCremoPlus</b> software for data transfer with live-screen function</li> </ul>

Specifications	
<b>Components</b>	MC main computer and 19-inch screen (1280 x 1024 pixels) for multi-touch operation, or MC main computer and 24-inch screen (1920 x 1080 pixels), or MC main computer with integrated 15.6-inch screen (1366 x 768 pixels) or 19-inch screen (1280 x 1024 pixels) or 24-inch screen (1920 x 1080 pixels) for multi-touch operation CC, UEC, or UMC controller unit TE operating panel (19-inch or 15.6-inch) with the following: <ul style="list-style-type: none"> <li>• Integrated machine operating panel</li> <li>• Feed-rate and spindle override potentiometers</li> <li>• Available with electronic handwheel (only for 19-inch version)</li> </ul>
<b>Operating system</b>	HEROS 5 real-time operating system for machine control
<b>NC program memory</b>	7.7 GB (on CFR Compact Flash memory card)
<b>Input resolution and display step</b>	X axis: 0.5 µm; diameter: 1 µm U, V, W, Y, Z axis: 1 µm B, C1/C2 axis: 0.001°
<b>Interpolation</b>	Straight: in 2 main axes (max.: ±100 m), optional in 3 main axes Circle: in 2 axes (max. radius: 999 m), optional additional linear interpolation of the third axis C1/C2 axis: interpolation of the linear axes X and Z with the C1/C2 axis (option) B axis: 5-axis interpolation between X, Z, Y, B, and C axis (option)
<b>Feed rate</b>	mm/min or mm/revolution Constant cutting speed Max. feed rate (60 000/number of pole pairs x ball screw pitch) at $f_{PWM} = 5000$ Hz
<b>Main spindle</b>	Maximum: 60 000 rpm (with option 49, max. 120 000 rpm) for motors with one pole pair
<b>Axis feedback control</b>	Integrated digital motor control for synchronous and asynchronous motors Position control resolution: signal period of the position encoder/1024 Position controller cycle time: 0.2 ms Speed controller cycle time: 0.2 ms Current controller cycle time: minimum 0.05 ms
<b>Error compensation</b>	Linear and nonlinear axis error, backlash, reversal peaks during circular movements, static friction
<b>Data interfaces</b>	1000BASE-T Gigabit Ethernet interface 4 x USB (1 x USB 2.0 on front; 3 x USB 3.0 on rear)
<b>Diagnostics</b>	Fast and simple troubleshooting through integrated diagnostic aids
<b>Ambient temperature</b>	Operation: In electrical cabinet: 5 °C to 40 °C In operating panel: 0 °C to 50 °C Storage: -20 °C to 60 °C





# HEIDENHAIN

## DR. JOHANNES HEIDENHAIN GmbH

Dr.-Johannes-Heidenhain-Straße 5

83301 Traunreut, Germany

☎ +49 8669 31-0

FAX +49 8669 32-5061

E-mail: info@heidenhain.de

www.heidenhain.de

Vollständige und weitere Adressen siehe [www.heidenhain.de](http://www.heidenhain.de)  
For complete and further addresses see [www.heidenhain.com](http://www.heidenhain.com)

<b>DE</b>	<b>HEIDENHAIN Vertrieb Deutschland</b> 83301 Traunreut, Deutschland ☎ 08669 31-3132 FAX 08669 32-3132 E-Mail: hd@heidenhain.de	<b>DK</b>	Denmark → SE	<b>NZ</b>	<b>Llama ENGINEERING Ltd</b> 5012 Wellington, New Zealand E-mail: info@llamaengineering.co.nz
	<b>HEIDENHAIN Technisches Büro Nord</b> 12681 Berlin, Deutschland ☎ 030 54705-240	<b>ES</b>	<b>FARRESA ELECTRONICA S.A.</b> 08028 Barcelona, Spain www.farresa.es	<b>PH</b>	<b>MACHINEBANKS' CORPORATION</b> Quezon City, Philippines 1113 E-mail: info@machinebanks.com
	<b>HEIDENHAIN Technisches Büro Mitte</b> 07751 Jena, Deutschland ☎ 03641 4728-250	<b>FI</b>	<b>HEIDENHAIN Scandinavia AB</b> 01740 Vantaa, Finland www.heidenhain.fi	<b>PL</b>	<b>APS</b> 02-384 Warszawa, Poland www.heidenhain.pl
	<b>HEIDENHAIN Technisches Büro West</b> 44379 Dortmund, Deutschland ☎ 0231 618083-0	<b>FR</b>	<b>HEIDENHAIN FRANCE sarl</b> 92310 Sèvres, France www.heidenhain.fr	<b>PT</b>	<b>FARRESA ELECTRÓNICA, LDA.</b> 4470 - 177 Maia, Portugal www.farresa.pt
	<b>HEIDENHAIN Technisches Büro Südwest</b> 70771 Leinfelden-Echterdingen, Deutschland ☎ 0711 993395-0	<b>GB</b>	<b>HEIDENHAIN (G.B.) Limited</b> Burgess Hill RH15 9RD, United Kingdom www.heidenhain.co.uk	<b>RO</b>	<b>HEIDENHAIN Reprezentanță Romania</b> Braşov, 500407, Romania www.heidenhain.ro
	<b>HEIDENHAIN Technisches Büro Südost</b> 83301 Traunreut, Deutschland ☎ 08669 31-1337	<b>GR</b>	<b>MB Milionis Vassilis</b> 17341 Athens, Greece www.heidenhain.gr	<b>RS</b>	Serbia → BG
		<b>HR</b>	Croatia → SL	<b>RU</b>	<b>GERTNER Service</b> 119002 Moscow, Russian Federation www.heidenhain.ru
		<b>HU</b>	<b>HEIDENHAIN Kereskedelmi Képviselet</b> 1239 Budapest, Hungary www.heidenhain.hu	<b>SE</b>	<b>HEIDENHAIN Scandinavia AB</b> 12739 Skärholmen, Sweden www.heidenhain.se
<b>AR</b>	<b>NAKASE SRL.</b> B1653AOX Villa Ballester, Argentina www.heidenhain.com.ar	<b>ID</b>	<b>PT Servitama Era Toolsindo</b> Jakarta 13930, Indonesia E-mail: ptset@group.gts.co.id	<b>SG</b>	<b>HEIDENHAIN PACIFIC PTE LTD</b> Singapore 408593 www.heidenhain.com.sg
<b>AT</b>	<b>HEIDENHAIN Techn. Büro Österreich</b> 83301 Traunreut, Germany www.heidenhain.de	<b>IL</b>	<b>NEUMO VARGUS MARKETING LTD.</b> Holon, 5885948, Israel E-mail: neumo@neumo-vargus.co.il	<b>SK</b>	<b>KOPRETINA TN s.r.o.</b> 91101 Trencin, Slovakia www.kopretina.sk
<b>AU</b>	<b>FCR MOTION TECHNOLOGY PTY LTD</b> Ravenhall Victoria 3023, Australia E-mail: sales@fcrmotion.com	<b>IN</b>	<b>HEIDENHAIN Optics &amp; Electronics India Private Limited</b> Chetpet, Chennai 600 031, India www.heidenhain.in	<b>SL</b>	<b>NAVO d.o.o.</b> 2000 Maribor, Slovenia www.heidenhain.si
<b>BE</b>	<b>HEIDENHAIN NV</b> 1760 Roosdaal, Belgium www.heidenhain.be	<b>IT</b>	<b>HEIDENHAIN ITALIANA S.r.l.</b> 20128 Milano, Italy www.heidenhain.it	<b>TH</b>	<b>HEIDENHAIN (THAILAND) LTD</b> Bangkok 10250, Thailand www.heidenhain.co.th
<b>BG</b>	<b>ESD Bulgaria Ltd.</b> Sofia 1172, Bulgaria www.esd.bg	<b>JP</b>	<b>HEIDENHAIN K.K.</b> Tokyo 102-0083, Japan www.heidenhain.co.jp	<b>TR</b>	<b>T&amp;M Mühendislik San. ve Tic. LTD. ŞTİ.</b> 34775 Y. Dudullu – Umraniye-Istanbul, Turkey www.heidenhain.com.tr
<b>BR</b>	<b>HEIDENHAIN Brasil Ltda.</b> 04763-070 – São Paulo – SP, Brazil www.heidenhain.com.br	<b>KR</b>	<b>HEIDENHAIN Korea Ltd.</b> Anyang-si, Gyeonggi-do, 14087 South Korea www.heidenhain.co.kr	<b>TW</b>	<b>HEIDENHAIN CO., LTD.</b> Taichung 40768, Taiwan www.heidenhain.com.tw
<b>BY</b>	<b>GERTNER Service</b> 220026 Minsk, Belarus www.heidenhain.by	<b>MX</b>	<b>HEIDENHAIN CORPORATION MEXICO</b> 20290 Aguascalientes, AGS., Mexico E-mail: info@heidenhain.com	<b>UA</b>	<b>GERTNER Service</b> 02094 Kiev, Ukraine www.heidenhain.ua
<b>CA</b>	<b>HEIDENHAIN CORPORATION</b> Mississauga, Ontario L5T2N2, Canada www.heidenhain.com	<b>MY</b>	<b>ISOSERVE SDN. BHD.</b> 43200 Balakong, Selangor E-mail: sales@isoserve.com.my	<b>US</b>	<b>HEIDENHAIN CORPORATION</b> Schaumburg, IL 60173-5337, USA www.heidenhain.us
<b>CH</b>	<b>HEIDENHAIN (SCHWEIZ) AG</b> 8603 Schwerzenbach, Switzerland www.heidenhain.ch	<b>NL</b>	<b>HEIDENHAIN NEDERLAND B.V.</b> 6716 BM Ede, Netherlands www.heidenhain.nl	<b>VN</b>	<b>AMS Co. Ltd</b> HCM City, Vietnam E-mail: davidgoh@amsvn.com
<b>CN</b>	<b>DR. JOHANNES HEIDENHAIN (CHINA) Co., Ltd.</b> Beijing 101312, China www.heidenhain.com.cn	<b>NO</b>	<b>HEIDENHAIN Scandinavia AB</b> 7300 Orkanger, Norway www.heidenhain.no	<b>ZA</b>	<b>MAFEMA SALES SERVICES C.C.</b> Kyalami 1684, South Africa www.heidenhain.co.za
<b>CZ</b>	<b>HEIDENHAIN s.r.o.</b> 102 00 Praha 10, Czech Republic www.heidenhain.cz				